

# User's Guide

## GS1900 Series

GbE Smart Managed Switch

### Default Login Details

IP Address	http://192.168.1.1 (In-band ports)
User Name	admin
Password	1234

Version 2.40 Edition 2, 01/2018

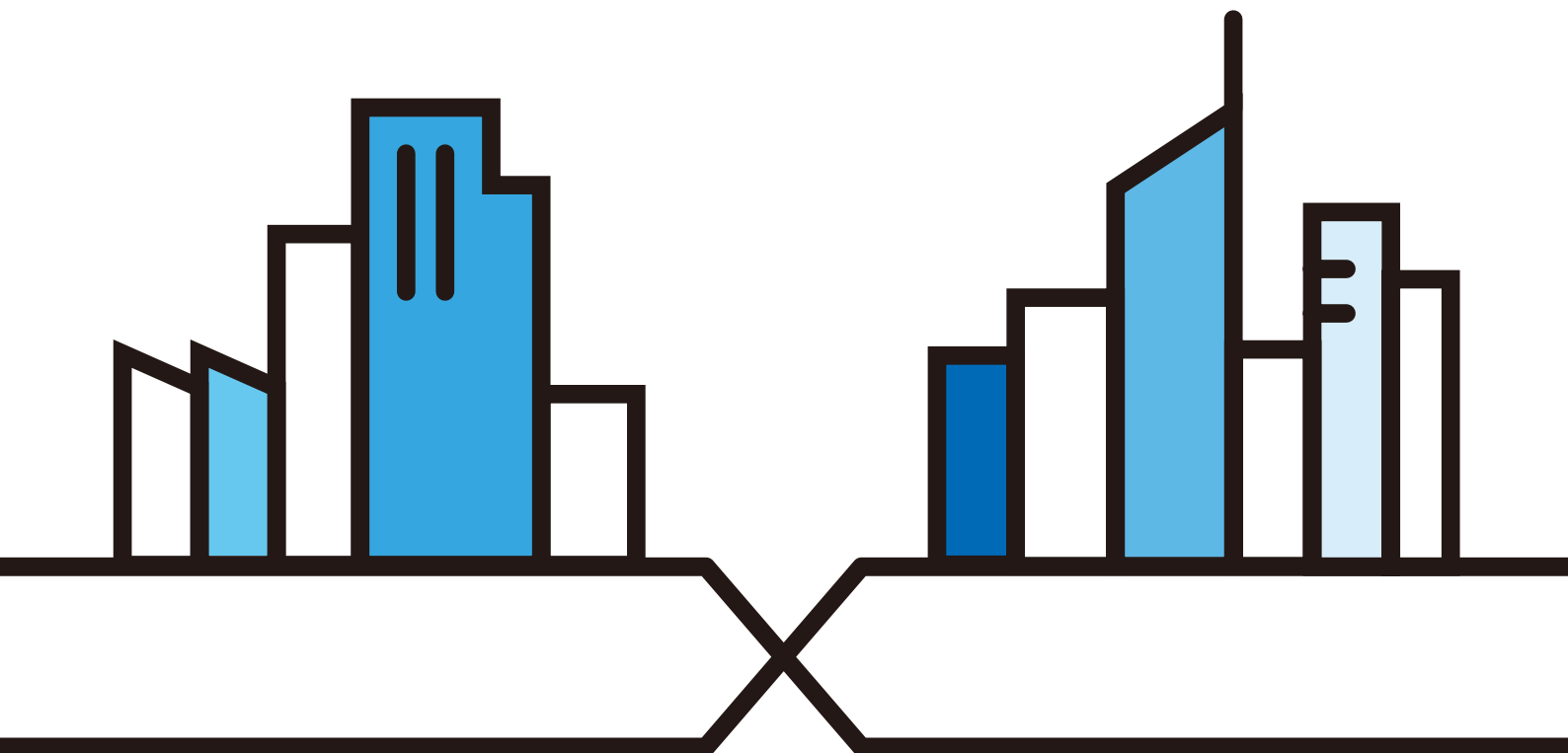

---

## **IMPORTANT!**

### **READ CAREFULLY BEFORE USE.**

### **KEEP THIS GUIDE FOR FUTURE REFERENCE.**

Screenshots and graphics in this book may differ slightly from your product due to differences in your product firmware or your computer operating system. Every effort has been made to ensure that the information in this manual is accurate.

Note: This guide is a reference for a series of products. Therefore some features or options in this guide may not be available in your product.

Note: It is recommended you use the Web Configurator to configure the Switch.

### **Related Documentation**

- Online Help  
Click the help link for a description of the fields in the Switch menus.
- More Information  
Go to [support.zyxel.com](http://support.zyxel.com) to find other information on the Switch.



# Document Conventions

## Warnings and Notes

These are how warnings and notes are shown in this guide.

**Warnings tell you about things that could harm you or your device.**









Note: Notes tell you other important information (for example, other things you may need to configure or helpful tips) or recommendations.

## Syntax Conventions

- All models may be referred to as the "Switch" in this guide.
- Product labels, screen names, field labels and field choices are all in **bold** font.
- A right angle bracket ( > ) within a screen name denotes a mouse click. For example, **Configuration > System > Information** means you first click **Configuration** in the navigation panel, then the **System** sub menu and finally the **Information** tab to get to that screen.

## Icons Used in Figures

Figures in this user guide may use the following generic icons. The Switch icon is not an exact representation of your device.

Switch 	Generic Switch 	Generic Router 
IP Camera 	Firewall 	Cell Tower 
Printer 	Server 	

# Contents Overview

<b>User's Guide</b> .....	<b>15</b>
Getting to Know Your Switch .....	16
Hardware Installation and Connection .....	20
Hardware Overview .....	25
ZON Utility .....	34
The Web Configurator .....	36
Getting Start .....	45
<b>Technical Reference</b> .....	<b>55</b>
Monitor: System .....	56
Monitor: Port .....	59
Monitor: VLAN .....	68
Monitor: MAC Table .....	74
Monitor: Link Aggregation .....	77
Monitor: Loop Guard .....	79
Monitor: Multicast .....	82
Monitor: Spanning Tree .....	86
Monitor: LLDP .....	92
Monitor: Security .....	96
Monitor: Management .....	99
Configuration: System .....	102
Configuration: Port .....	107
Configuration: VLAN .....	120
Configuration: MAC Table .....	133
Configuration: Link Aggregation .....	137
Configuration: Loop Guard .....	143
Configuration: Mirror .....	146
Configuration: Time Range Group .....	148
Configuration: Multicast .....	153
Configuration: Spanning Tree .....	161
Configuration: LLDP .....	170
Configuration: QoS .....	182
Configuration: Security .....	191
Configuration: AAA .....	201
Configuration: Management .....	206
Maintenance .....	222
Troubleshooting .....	234

# Table of Contents

<b>Document Conventions</b> .....	<b>3</b>
<b>Contents Overview</b> .....	<b>4</b>
<b>Table of Contents</b> .....	<b>5</b>
<b>Part I: User's Guide</b> .....	<b>15</b>
<b>Chapter 1</b>	
<b>Getting to Know Your Switch</b> .....	<b>16</b>
1.1 Introduction .....	16
1.1.1 Bridging Example .....	16
1.1.2 Gigabit Ethernet to the Desktop .....	17
1.1.3 IEEE 802.1Q VLAN Application Example .....	17
1.1.4 IPv6 Support .....	18
1.2 Ways to Manage the Switch .....	18
1.3 Good Habits for Managing the Switch .....	19
<b>Chapter 2</b>	
<b>Hardware Installation and Connection</b> .....	<b>20</b>
2.1 Freestanding Installation .....	20
2.2 Hardware Installation .....	21
2.2.1 Wall Mounting .....	21
2.2.2 Rack Mounting .....	22
<b>Chapter 3</b>	
<b>Hardware Overview</b> .....	<b>25</b>
3.1 Front Panel Connections .....	25
3.1.1 Ethernet Ports .....	27
3.1.2 SFP Slots .....	27
3.2 Rear Panel .....	29
3.2.1 Power Connection .....	30
3.3 LEDs .....	31
3.4 Reset to Factory Defaults .....	32
<b>Chapter 4</b>	
<b>ZON Utility</b> .....	<b>34</b>
4.1 Zyxel One Network (ZON) Utility Screen .....	34

<b>Chapter 5</b>	
<b>The Web Configurator.....</b>	<b>36</b>
5.1 Overview .....	36
5.2 Access .....	36
5.3 Navigating the Web Configurator .....	38
5.3.1 Title Bar .....	38
5.3.2 Navigation Panel .....	39
<b>Chapter 6</b>	
<b>Getting Start.....</b>	<b>45</b>
6.1 Overview .....	45
6.1.1 What You Can Do in this Chapter .....	45
6.2 Getting Start .....	45
6.2.1 Wizard .....	46
<b>Part II: Technical Reference.....</b>	<b>55</b>
<b>Chapter 7</b>	
<b>Monitor: System.....</b>	<b>56</b>
7.1 Overview .....	56
7.1.1 What You Can Do in this Chapter .....	56
7.2 IP .....	56
7.2.1 IPv4 .....	56
7.2.2 IPv6 .....	57
7.3 Information .....	57
<b>Chapter 8</b>	
<b>Monitor: Port .....</b>	<b>59</b>
8.1 Overview .....	59
8.1.1 What You Can Do in this Chapter .....	59
8.2 Port .....	59
8.2.1 Status .....	59
8.2.2 Port Counters .....	60
8.2.3 Bandwidth Utilization .....	62
8.3 PoE .....	63
8.4 Bandwidth Management .....	65
8.4.1 Bandwidth Control .....	65
8.5 Storm Control .....	66
<b>Chapter 9</b>	
<b>Monitor: VLAN.....</b>	<b>68</b>

9.1 Overview .....	68
9.1.1 What You Can Do in this Chapter .....	68
9.2 VLAN .....	68
9.2.1 VLAN .....	68
9.2.2 Port .....	69
9.2.3 VLAN Port .....	70
9.3 Guest VLAN .....	71
9.4 Voice VLAN .....	72
<b>Chapter 10</b>	
<b>Monitor: MAC Table .....</b>	<b>74</b>
10.1 Overview .....	74
10.1.1 What You Can Do in this Chapter .....	75
10.2 MAC Table .....	75
<b>Chapter 11</b>	
<b>Monitor: Link Aggregation .....</b>	<b>77</b>
11.1 Overview .....	77
11.1.1 What You Can Do in this Chapter .....	77
11.2 Link Aggregation .....	77
<b>Chapter 12</b>	
<b>Monitor: Loop Guard .....</b>	<b>79</b>
12.1 Overview .....	79
12.1.1 What You Can Do in this Chapter .....	80
12.2 Loop Guard .....	80
<b>Chapter 13</b>	
<b>Monitor: Multicast.....</b>	<b>82</b>
13.1 Overview .....	82
13.1.1 What You Can Do in this Chapter .....	82
13.2 IGMP .....	82
13.2.1 VLAN .....	82
13.2.2 Statistics .....	83
13.2.3 Group .....	84
13.2.4 Router .....	85
<b>Chapter 14</b>	
<b>Monitor: Spanning Tree.....</b>	<b>86</b>
14.1 Overview .....	86
14.1.1 What You Can Do in this Chapter .....	86
14.2 Spanning Tree .....	86
14.2.1 CIST .....	86

---

14.2.2 CIST Port .....	87
14.2.3 MST .....	88
14.2.4 MST Port .....	89
14.2.5 STP Statistics .....	90
<b>Chapter 15</b>	
<b>Monitor: LLDP .....</b>	<b>92</b>
15.1 Overview .....	92
15.1.1 What You Can Do in this Chapter .....	92
15.2 LLDP .....	92
15.2.1 Statistics .....	92
15.2.2 Remote Information .....	93
15.2.3 Overloading .....	94
<b>Chapter 16</b>	
<b>Monitor: Security .....</b>	<b>96</b>
16.1 Overview .....	96
16.1.1 What You Can Do in this Chapter .....	96
16.2 Port Security .....	96
16.3 802.1X .....	97
16.3.1 Port .....	97
16.3.2 Authenticated Hosts .....	98
<b>Chapter 17</b>	
<b>Monitor: Management .....</b>	<b>99</b>
17.1 Overview .....	99
17.1.1 What You Can Do in this Chapter .....	99
17.2 Syslog .....	99
17.3 Error Disable .....	100
<b>Chapter 18</b>	
<b>Configuration: System .....</b>	<b>102</b>
18.1 Overview .....	102
18.1.1 What You Can Do in this Chapter .....	102
18.2 IP .....	102
18.2.1 The IPv4 Screen .....	102
18.2.2 The IPv6 Screen .....	103
18.3 Time .....	104
18.3.1 The System Time Screen .....	104
18.3.2 The SNTP Server Screen .....	105
18.4 Information .....	105
18.4.1 The System Information Screen .....	105



<b>Chapter 19</b>	
<b>Configuration: Port</b> .....	<b>107</b>
19.1 Overview .....	107
19.1.1 What You Can Do in this Chapter .....	107
19.2 Port .....	107
19.2.1 The Port Screen .....	107
19.2.2 The Port Edit Screen .....	108
19.3 EEE .....	109
19.3.1 The EEE Screen .....	110
19.3.2 The EEE Edit Screen .....	110
19.4 PoE .....	111
19.4.1 The Global Screen .....	111
19.4.2 The Port Screen .....	112
19.4.3 The PoE Edit Screen .....	114
19.5 Bandwidth Management .....	116
19.5.1 The Bandwidth Control Screen .....	116
19.5.2 The Port Rate Edit Screen .....	117
19.6 Storm Control .....	117
19.6.1 The Port Screen .....	118
19.6.2 The Port Edit Screen .....	118
<b>Chapter 20</b>	
<b>Configuration: VLAN</b> .....	<b>120</b>
20.1 Overview .....	120
20.1.1 What You Can Do in this Chapter .....	120
20.2 VLAN .....	121
20.2.1 The VLAN Screen .....	121
20.2.2 The VLAN Add Screen .....	121
20.2.3 The Port Screen .....	122
20.2.4 The Port Edit Screen .....	123
20.2.5 The VLAN Port Screen .....	124
20.3 Guest VLAN .....	126
20.3.1 The Global Screen .....	126
20.3.2 The Port Screen .....	127
20.3.3 The Port Edit Screen .....	127
20.4 Voice VLAN .....	128
20.4.1 The Global Screen .....	128
20.4.2 The OUI Screen .....	129
20.4.3 The OUI Add/Edit Screen .....	130
20.4.4 The Port Screen .....	130
20.4.5 The Port Edit Screen .....	131

<b>Chapter 21</b>	
<b>Configuration: MAC Table.....</b>	<b>133</b>
21.1 Overview .....	133
21.1.1 What You Can Do in this Chapter .....	133
21.2 MAC Table .....	133
21.2.1 The Static MAC Screen .....	133
21.2.2 The Static MAC Add Screen .....	134
21.2.3 The Filtering MAC Screen .....	134
21.2.4 The Filtering MAC Add Screen .....	135
21.2.5 The Dynamic Age Screen .....	135
<b>Chapter 22</b>	
<b>Configuration: Link Aggregation.....</b>	<b>137</b>
22.1 Overview .....	137
22.1.1 What You Can Do in this Chapter .....	137
22.2 Link Aggregation .....	137
22.2.1 The Global Screen .....	137
22.2.2 The LAG Management Screen .....	138
22.2.3 The LAG Add Screen .....	139
22.2.4 The LAG Port Screen .....	140
22.2.5 The LAG Port Edit Screen .....	140
22.2.6 The LACP Port Screen .....	141
22.2.7 The LACP Port Edit Screen .....	142
<b>Chapter 23</b>	
<b>Configuration: Loop Guard.....</b>	<b>143</b>
23.1 Overview .....	143
23.2 Loop Guard .....	143
23.2.1 The Global Screen .....	143
23.2.2 The Loop Guard Port .....	144
23.2.3 The Port Edit Screen .....	144
<b>Chapter 24</b>	
<b>Configuration: Mirror.....</b>	<b>146</b>
24.1 Overview .....	146
24.2 Mirror .....	146
24.2.1 The Mirror Screen .....	146
<b>Chapter 25</b>	
<b>Configuration: Time Range Group.....</b>	<b>148</b>
25.1 Overview .....	148
25.1.1 What You Can Do .....	148
25.2 Time Range Group .....	148

25.2.1 The Time Range Group Screen .....	148
25.2.2 The Time Range Add Screen .....	149
25.2.3 The Time Range Edit Screen .....	150
<b>Chapter 26</b>	
<b>Configuration: Multicast .....</b>	<b>153</b>
26.1 Overview .....	153
26.2 IGMP .....	153
26.2.1 The Global Screen .....	153
26.2.2 The VLAN Screen .....	154
26.2.3 The Edit IGMP Screen .....	155
26.2.4 The Router Port Screen .....	156
26.2.5 The Add/Edit Router Port Screen .....	156
26.2.6 The Profile Screen .....	157
26.2.7 The Add/Edit Profile Screen .....	158
26.2.8 The Throttling Screen .....	158
26.2.9 The Edit Throttling Screen .....	159
<b>Chapter 27</b>	
<b>Configuration: Spanning Tree .....</b>	<b>161</b>
27.1 Overview .....	161
27.2 Spanning Tree .....	161
27.2.1 The Global Screen .....	161
27.2.2 The STP Port Screen .....	162
27.2.3 The STP Port Edit Screen .....	163
27.2.4 The CIST Screen .....	164
27.2.5 The CIST Port Screen .....	165
27.2.6 The CIST Port Edit Screen .....	166
27.2.7 The MST Screen .....	166
27.2.8 The Add/Edit MST Screen .....	167
27.2.9 The MST Port Screen .....	167
27.2.10 The MST Port Edit Screen .....	168
<b>Chapter 28</b>	
<b>Configuration: LLDP .....</b>	<b>170</b>
28.1 Overview .....	170
28.2 LLDP .....	170
28.2.1 The Global Screen .....	170
28.2.2 The Port Screen .....	171
28.2.3 The Port Edit Screen .....	172
28.2.4 The Local Information Screen .....	173
28.2.5 The Local Information Edit Screen .....	175
28.2.6 The MED Network Policy Screen .....	178

28.2.7 The MED Network Policy Add/Edit Screen .....	178
28.2.8 The MED Port Screen .....	179
28.2.9 The MED Port Edit Screen .....	180
<b>Chapter 29</b>	
<b>Configuration: QoS .....</b>	<b>182</b>
29.1 Overview .....	182
29.2 General .....	182
29.2.1 The Port Screen .....	182
29.2.2 The Port Edit Screen .....	183
29.2.3 The Queue Screen .....	184
29.2.4 The CoS Mapping Screen .....	185
29.2.5 The DSCP Mapping Screen .....	186
29.2.6 The IP Precedence Mapping Screen .....	187
29.3 Trust Mode .....	188
29.3.1 The Global Screen .....	188
29.3.2 The Port Screen .....	188
29.3.3 The Trust Mode Edit Screen .....	189
<b>Chapter 30</b>	
<b>Configuration: Security .....</b>	<b>191</b>
30.1 Overview .....	191
30.2 Port Security .....	191
30.2.1 The Global Screen .....	191
30.2.2 The Port Screen .....	191
30.2.3 The Port Edit Screen .....	192
30.3 Protected Port .....	193
30.3.1 The Protected Port Screen .....	193
30.3.2 The Protected Port Edit Screen .....	194
30.4 802.1X .....	195
30.4.1 The Global Screen .....	195
30.4.2 The Port Screen .....	195
30.4.3 The Port Edit Screen .....	196
30.5 DoS .....	197
30.5.1 The Global Screen .....	197
30.5.2 The Port Screen .....	198
30.5.3 The Port Edit Screen .....	199
30.5.4 DoS Attack Types .....	199
<b>Chapter 31</b>	
<b>Configuration: AAA .....</b>	<b>201</b>
31.1 Overview .....	201
31.2 Auth Method .....	201

31.2.1 The Auth Method Screen .....	201
31.2.2 The Auth Method Add/Edit Screen .....	202
31.3 RADIUS .....	202
31.3.1 The RADIUS Screen .....	202
31.3.2 The RADIUS Add/Edit Screen .....	203
31.4 TACACS+ .....	204
31.4.1 The TACACS+ Screen .....	204
31.4.2 The TACACS+ Add/Edit Screen .....	204
<b>Chapter 32</b>	
<b>Configuration: Management.....</b>	<b>206</b>
32.1 Overview .....	206
32.2 Syslog .....	206
32.2.1 The Global Screen .....	206
32.2.2 The Local Screen .....	206
32.2.3 The Local Add/Edit Screen .....	207
32.2.4 The Remote Screen .....	208
32.2.5 The Remote Add/Edit Screen .....	208
32.3 SNMP .....	209
32.3.1 The Global Screen .....	209
32.3.2 The Community Screen .....	210
32.3.3 The Community Add Screen .....	210
32.3.4 The Group Screen .....	211
32.3.5 The Group Add Screen .....	211
32.3.6 The User Screen .....	212
32.3.7 The User Add Screen .....	213
32.3.8 The Trap Screen .....	214
32.3.9 The Trap Destination Screen .....	214
32.3.10 The Trap Destination Add Screen .....	215
32.4 Error Disable .....	216
32.4.1 The Error Disabled Screen .....	216
32.5 HTTP/HTTPS .....	217
32.5.1 The HTTP Screen .....	217
32.5.2 The HTTPS Screen .....	217
32.6 Users .....	218
32.6.1 The Users Screen .....	218
32.6.2 The Users Add/Edit Screen .....	219
32.7 Remote Access Control .....	220
32.7.1 The Global Screen .....	220
32.7.2 The Profile Add/Edit Screen .....	220
<b>Chapter 33</b>	
<b>Maintenance.....</b>	<b>222</b>

---

33.1 Firmware Upgrade .....	222
33.1.1 Overview .....	222
33.1.2 Upgrade the firmware from a file on a server .....	223
33.1.3 Upgrade the firmware from a file on your computer .....	223
33.2 Firmware Management .....	223
33.2.1 Overview .....	223
33.2.2 Select the Active Image .....	224
33.3 Backup a Configuration File .....	225
33.3.1 Overview .....	225
33.3.2 Back up configuration or log files to a server .....	226
33.3.3 Back up configuration or log files to your computer .....	226
33.4 Restore a Configuration File .....	226
33.4.1 Overview .....	226
33.4.2 Restore the configuration from a file on a server .....	227
33.4.3 Restore the configuration from a file on your computer .....	227
33.5 Manage Configuration Files .....	227
33.5.1 Overview .....	227
33.6 Reset to Factory Defaults .....	228
33.6.1 Overview .....	228
33.6.2 Reset the Switch to Factory Defaults .....	228
33.7 Network Diagnostics .....	229
33.7.1 Port Test .....	229
33.7.2 IPv4 Ping Test .....	229
33.7.3 IPv6 Ping Test .....	230
33.7.4 Trace Route .....	231
33.8 Reboot .....	232
33.8.1 Overview .....	232
33.8.2 Reboot the Switch .....	233
<b>Chapter 34</b>	
<b>Troubleshooting.....</b>	<b>234</b>
34.1 Power, Hardware Connections, and LEDs .....	234
34.2 Switch Access and Login .....	235
34.3 Switch Configuration .....	236
Appendix A Customer Support .....	237
Appendix B Legal Information .....	243
<b>Index .....</b>	<b>250</b>

---

# PART I

## User's Guide

---

# CHAPTER 1

## Getting to Know Your Switch

This chapter introduces the main features and applications of the Switch.

### 1.1 Introduction

The GS1900 series is a new generation Gigabit Ethernet (GbE) Web-Managed Switch.

This User's Guide covers the following models:

Table 1 GS1900 Series Comparison Table

MODEL	GS1900-8	GS1900-8HP	GS1900-10HP	GS1900-16	GS1900-24E	GS1900-24	GS1900-24HP	GS1900-48	GS1900-48HP
100/1000 Mbps Port	8	-	-	16	24	24	-	48	24
100/1000 Mbps PoE Port	-	8	8	-	-	-	24	-	24
1G SFP Slots Fiber	-	-	2	-	-	2	2	2	2
Desktop	v	v	v	v	v				
Wall-mount	v	v	v	v	v				
Rack-mount				v	v	v	v	v	v
Power ON/OFF Switch	v	v	v	v	v				

See the datasheet for a full list of firmware features available on the Switch.

#### 1.1.1 Bridging Example

In this example the Switch connects different company departments (**RD** and **Sales**) to the corporate backbone. It can alleviate bandwidth contention and eliminate server and network bottlenecks. All users that need high bandwidth can connect to high-speed department servers via the Switch.



Figure 1 Bridging Application

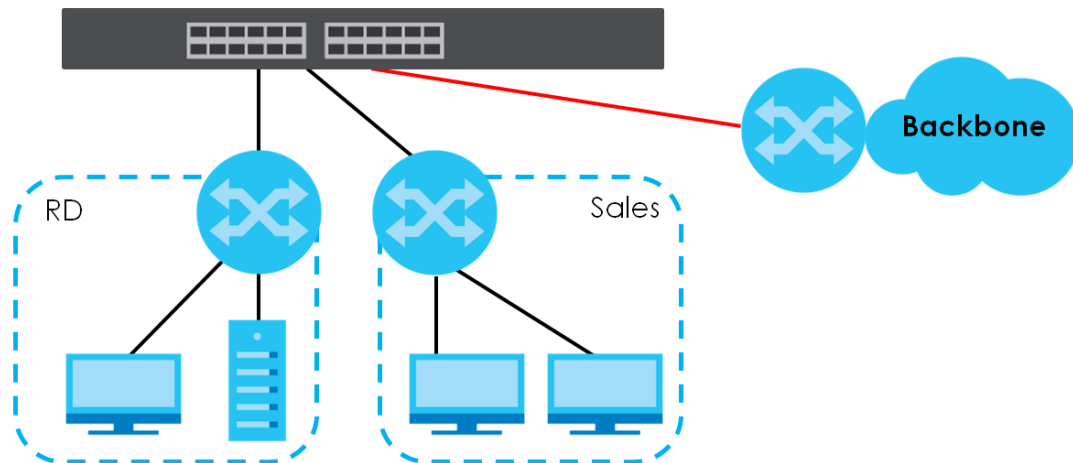

### 1.1.2 Gigabit Ethernet to the Desktop

The Switch is an ideal solution for small networks which demand high bandwidth for a group of heavy traffic users. You can connect computers and servers directly to the Switch's port or connect other switches to the Switch.

In this example, all computers can share high-speed applications on the server and access the Internet. To expand the network, simply add more networking devices such as switches, routers, computers, print servers and so on.

Figure 2 Gigabit to the Desktop

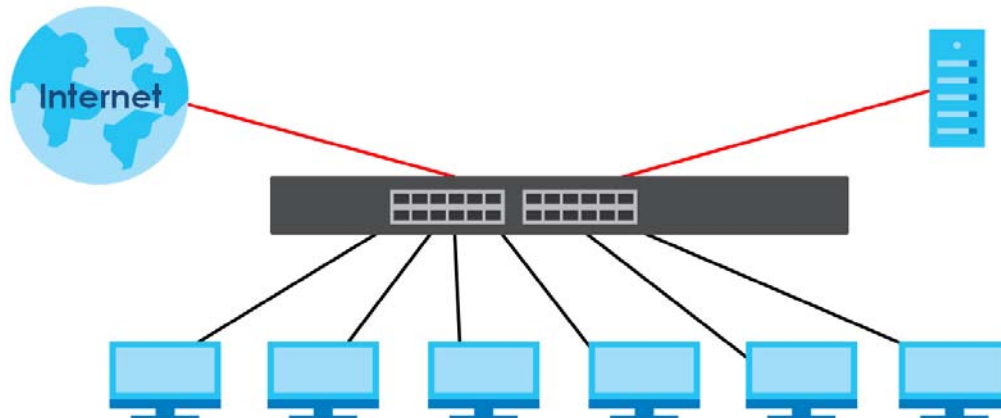

### 1.1.3 IEEE 802.1Q VLAN Application Example

A VLAN (Virtual Local Area Network) allows a physical network to be partitioned into multiple logical networks. Stations on a logical network belong to one or more groups. With VLAN, a station cannot directly talk to or hear from stations that are not in the same group(s) unless such traffic first goes through a router.

For more information on VLANs, refer to [Chapter 9 on page 68](#).

### 1.1.3.1 Tag-based VLAN Example

Ports in the same VLAN group share the same frame broadcast domain, thus increasing network performance by reducing broadcast traffic. VLAN groups can be modified at any time by adding, moving or changing ports without any re-cabling.

Shared resources such as a server can be used by all ports in the same VLAN as the server. In the following figure only ports that need access to the server need to be part of VLAN 1. Ports can belong to other VLAN groups too.

**Figure 3** Shared Server Using VLAN Example

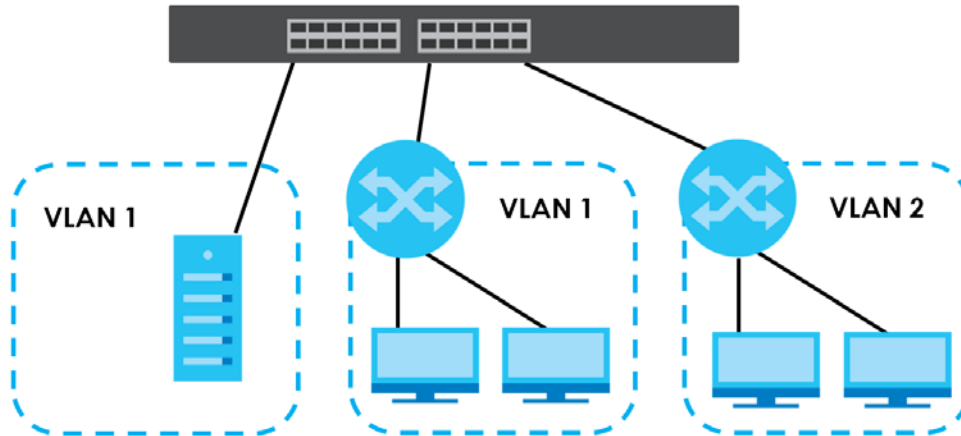

### 1.1.4 IPv6 Support

IPv6 (Internet Protocol version 6), is designed to enhance IP address size and features. The increase in IPv6 address size to 128 bits (from the 32-bit IPv4 address) allows up to  $3.4 \times 10^{38}$  IP addresses. At the time of writing, the Switch supports the following features.

- Static address assignment and stateless auto-configuration
- Neighbor Discovery Protocol (a protocol used to discover other IPv6 devices in a network)
- Remote Management using PING, SNMP, HTTP and TFTP services
- ICMPv6 to report errors encountered in packet processing and perform diagnostic functions, such as "PING"
- IPv4/IPv6 dual stack; the Switch can run IPv4 and IPv6 at the same time
- DHCPv6 client

## 1.2 Ways to Manage the Switch

Use any of the following methods to manage the Switch.

- Web Configurator. This is recommended for everyday management of the Switch using a (supported) web browser. See [Chapter 5 on page 36](#).

- TFTP. Use Trivial File Transfer Protocol for firmware upgrades and configuration backup/restore. See [Section 33.1 on page 222](#), [Section 33.3 on page 225](#), and [Section 33.4 on page 226](#)
- SNMP. The device can be configured by a SNMP manager. See [Section 32.3 on page 209](#).

## 1.3 Good Habits for Managing the Switch

Do the following things regularly to make the Switch more secure and to manage the Switch more effectively.

- Change the password. Use a password that's not easy to guess and that consists of different types of characters, such as numbers and letters.
- Write down the password and put it in a safe place.
- Back up the configuration (and make sure you know how to restore it). Restoring an earlier working configuration may be useful if the device becomes unstable or even crashes. If you forget your password, you will have to reset the Switch to its factory default settings. If you backed up an earlier configuration file, you would not have to totally re-configure the Switch. You could simply restore your last configuration.

# CHAPTER 2

## Hardware Installation and Connection

This chapter shows you how to install and connect the Switch.

### 2.1 Freestanding Installation

- 1 Make sure the Switch is clean and dry.
- 2 Set the Switch on a smooth, level surface strong enough to support the weight of the Switch and the connected cables. Make sure there is a power outlet nearby.
- 3 Make sure there is enough clearance around the Switch to allow air circulation and the attachment of cables and the power cord.
- 4 Remove the adhesive backing from the rubber feet.
- 5 Attach the rubber feet to each corner on the bottom of the Switch. These rubber feet help protect the Switch from shock or vibration and ensure space between devices when stacking.

**Figure 4** Attaching Rubber Feet

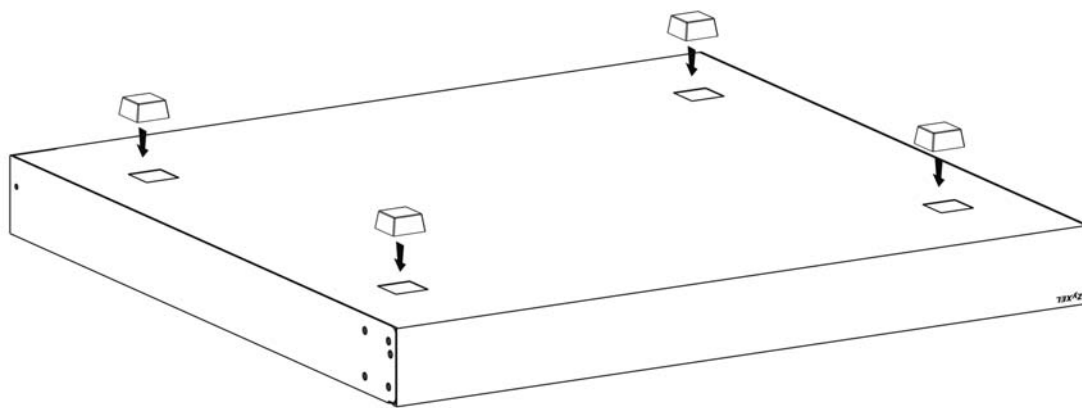

Note: Do NOT block the ventilation holes. Leave space between devices when stacking.

Note: For proper ventilation, allow at least 4 inches (10 cm) of clearance at the front and 3.4 inches (8 cm) at the back of the Switch. This is especially important for enclosed rack installations.

## 2.2 Hardware Installation

See [Table 1 on page 16](#) for a comparison of the hardware installation methods of each model:

Note: Ask an authorized technician to attach the Switch to the rack/wall.

Refer to [Section 2.2.2 on page 22](#) for rack-mounting instructions. Take note of the following:

- The Switch should have a minimum 25 mm space around it for ventilation.
- The Switch should be placed on a desk that has a level surface and that is able to support the weight of the Switch.

To start using it, simply connect the power cables and turn on the Switch.

### 2.2.1 Wall Mounting

Do the following to attach your Switch to a wall.

See the following table for how far apart to place the screws.

Table 2 Distance between the centers of the holes for wall mounting

GS1900-8	GS1900-8HP	GS1900-10HP	GS1900-16	GS1900-24E
176 mm	176 mm	176 mm	148 mm	207 mm

Screw the two screws provided with your Switch into the wall (see the figure in step 2). Use screws with 6 mm ~ 8 mm (0.24" ~ 0.31") wide heads. Do not screw the screws all the way in to the wall; leave a small gap between the head of the screw and the wall.

The gap must be big enough for the screw heads to slide into the screw slots and the connection cables to run down the back of the Switch.

Note: Make sure the screws are securely fixed to the wall and strong enough to hold the weight of the Switch with the connection cables.

Align the holes on the back of the Switch with the screws on the wall. Hang the Switch on the screws.

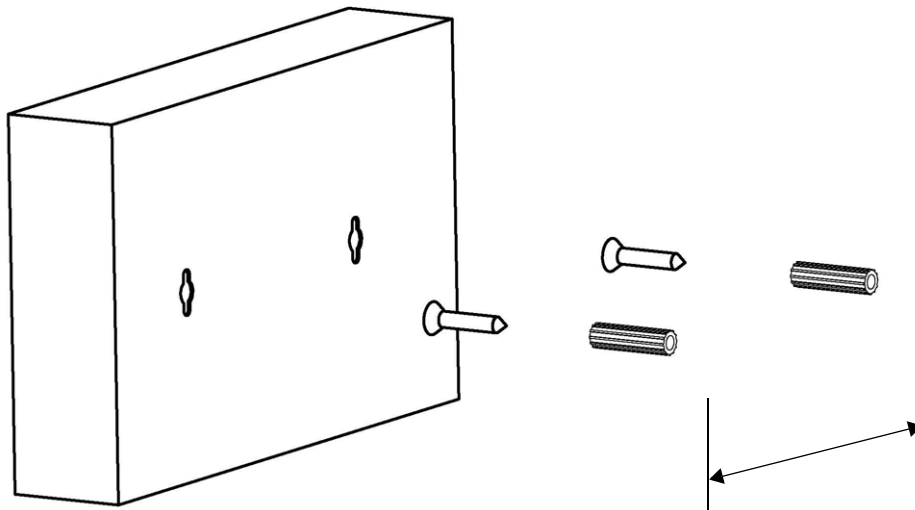

**The Switch should be wall-mounted horizontally. The Switch's side panels with ventilation slots should not be facing up or down as this position is less safe.**

## 2.2.2 Rack Mounting

The Switch can be mounted on an EIA standard size, 19-inch rack or in a wiring closet with other equipment. Follow the steps below to mount your Switch on a standard EIA rack using a rack-mounting kit.

### Rack-mounted Installation Requirements

- Two mounting brackets.
- Eight M3 flat head screws and a #2 Philips screwdriver.
- Four M5 flat head screws and a #2 Philips screwdriver.

**Failure to use the proper screws may damage the unit.**

### Precautions

- Make sure the rack will safely support the combined weight of all the equipment it contains.
- Make sure the position of the Switch does not make the rack unstable or top-heavy. Take all necessary precautions to anchor the rack securely before installing the unit.

### Attaching the Mounting Brackets to the Switch

- 1 Position a mounting bracket on one side of the Switch, lining up the four screw holes on the bracket with the screw holes on the side of the Switch.

**Figure 5** Attaching the Mounting Brackets (GS1900-16 and GS1900-24E)

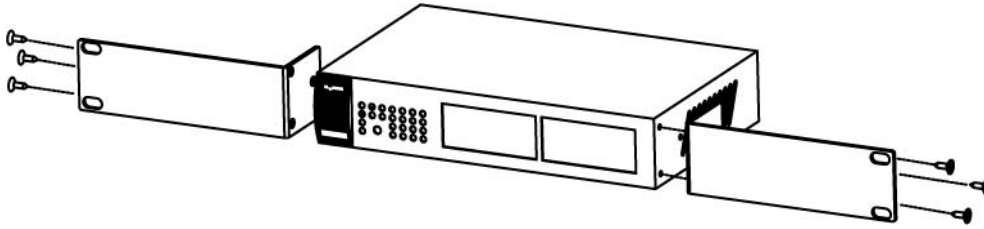

**Figure 6** Attaching the Mounting Brackets (GS1900-24, GS1900-24HP, GS1900-48, GS1900-48HP)

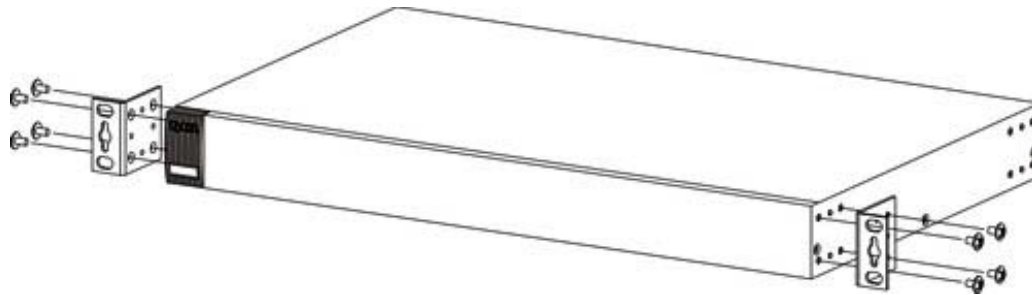

- 2 Using a #2 Philips screwdriver, install the M3 flat head screws through the mounting bracket holes into the Switch.
- 3 Repeat steps 1 and 2 to install the second mounting bracket on the other side of the Switch.
- 4 You may now mount the Switch on a rack. Proceed to the next section.

### 2.2.2.1 Mounting the Switch on a Rack

- 1 Position a mounting bracket (that is already attached to the Switch) on one side of the rack, lining up the two screw holes on the bracket with the screw holes on the side of the rack.

**Figure 7** Mounting the Switch on a Rack (GS1900-16 and GS1900-24E)

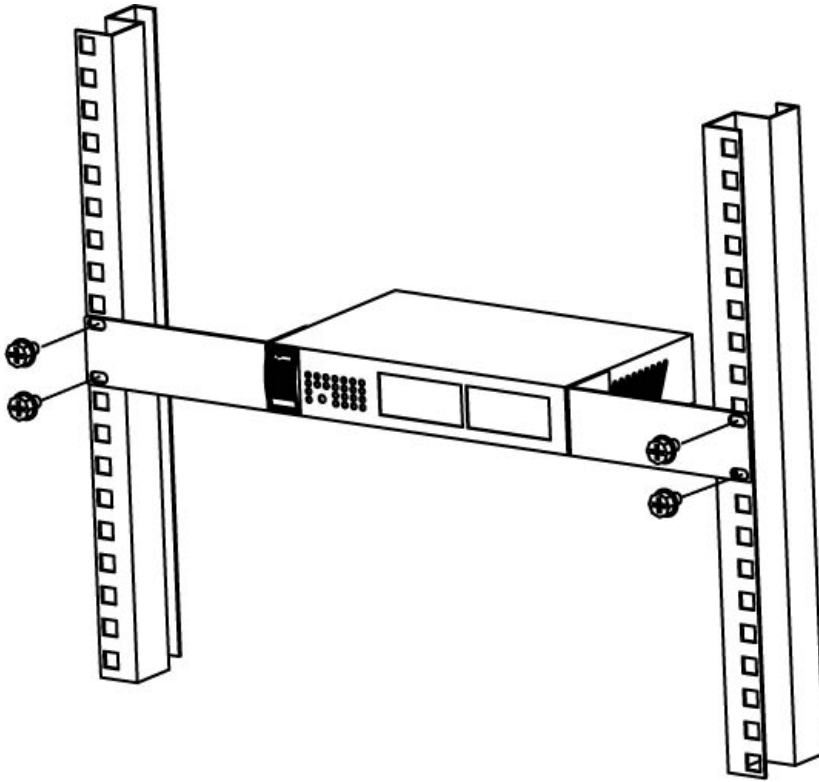

**Figure 8** Mounting the Switch on a Rack (GS1900-24, GS1900-24HP, GS1900-48, GS1900-48HP)

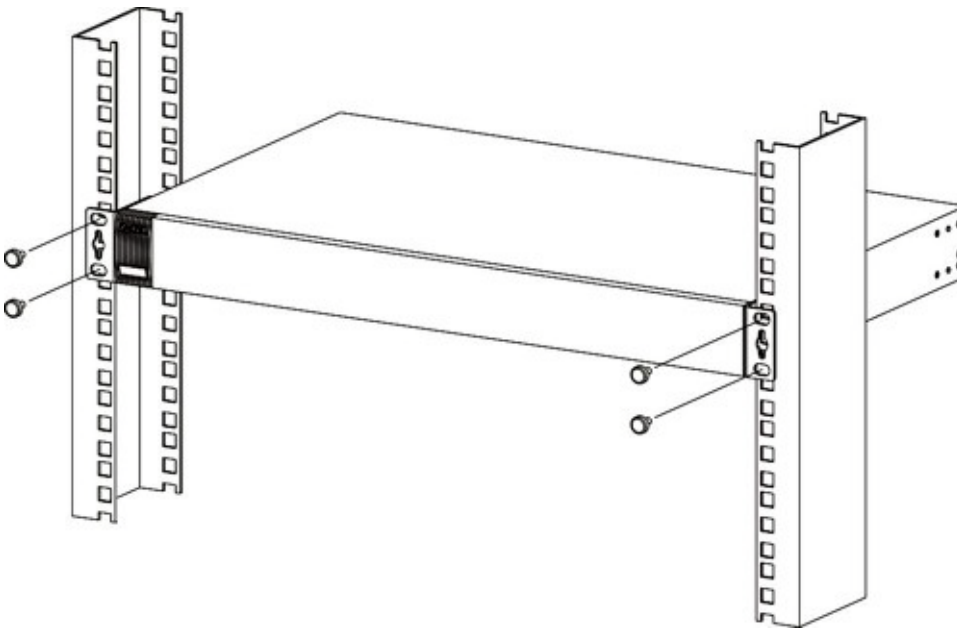

- 2 Using a #2 Phillips screwdriver, install the M5 flat head screws through the mounting bracket holes into the rack.
- 3 Repeat steps 1 and 2 to attach the second mounting bracket on the other side of the rack.



# CHAPTER 3

## Hardware Overview

This chapter describes the front panel and rear panel of the Switch and shows you how to make the hardware connections.

### 3.1 Front Panel Connections

The following figures show the front panels of the Switch.

Figure 9 Front Panel: GS1900-8

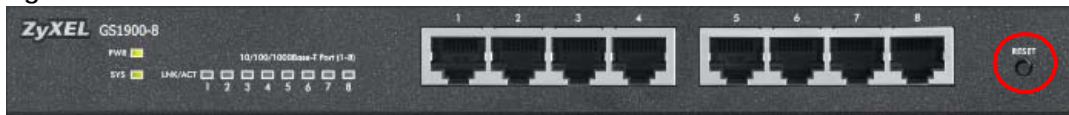

Figure 10 Front Panel: GS1900-8HP

Revision A1



Revision B1

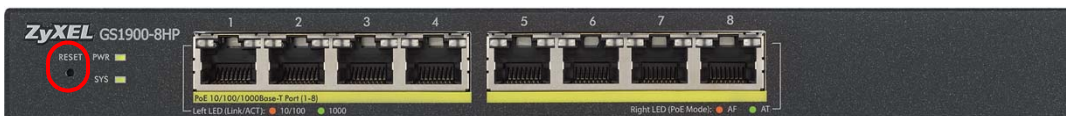

Figure 11 Front Panel: GS1900-10HP

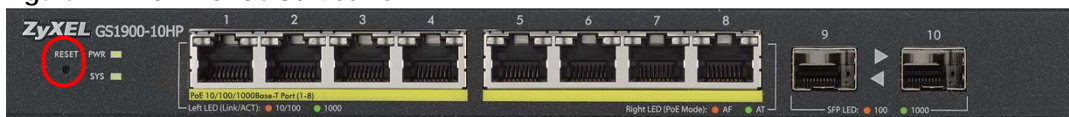

Figure 12 Front Panel: GS1900-16

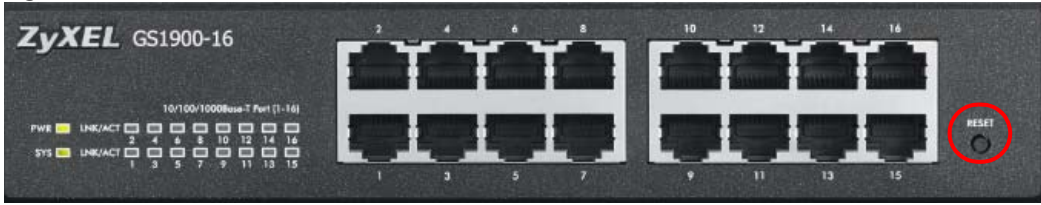

Figure 13 Front Panel: GS1900-24E

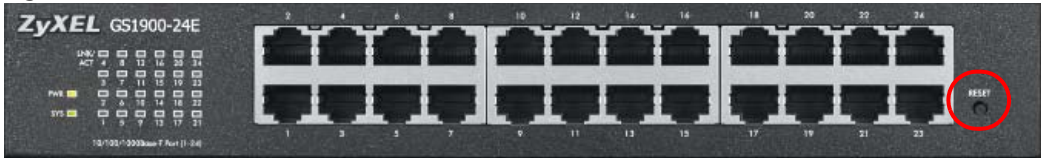

Figure 14 Front Panel: GS1900-24



Figure 15 Front Panel: GS1900-24HP



Figure 16 Front Panel: GS1900-48



Figure 17 Front Panel: GS1900-48HP

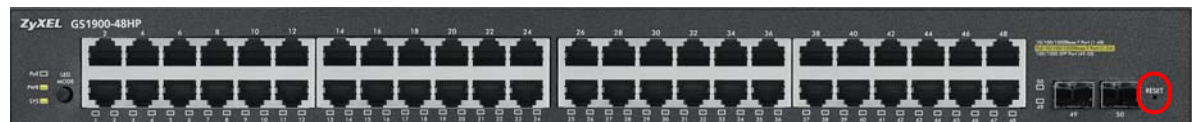

## 3.1.1 Ethernet Ports

The Switch has 1000Base-T auto-negotiating, auto-crossover Ethernet ports. In 10/100/1000 Mbps Gigabit Ethernet, the speed can be 10Mbps, 100 Mbps or 1000 Mbps. The duplex mode can be both half or full duplex at 100 Mbps and full duplex only at 1000 Mbps.

An auto-negotiating port can detect and adjust to the optimum Ethernet speed (10/100/1000 Mbps) and duplex mode (full duplex or half duplex) of the connected device.

An auto-crossover (auto-MDI/MDI-X) port automatically works with a straight-through or crossover Ethernet cable.

### 3.1.1.1 Default Ethernet Settings

The factory default negotiation settings for the Ethernet ports on the Switch are:

- Speed: Auto
- Duplex: Auto
- Flow control: Off

## 3.1.2 SFP Slots

These are slots for Small Form-Factor Pluggable (SFP) transceivers. A transceiver is a single unit that houses a transmitter and a receiver. Use a transceiver to connect a fiber-optic cable to the Switch. The Switch does not come with transceivers. You must use transceivers that comply with the Small Form-Factor Pluggable (SFP) Transceiver MultiSource Agreement (MSA). See the SFF committee's INF-8074i specification Rev 1.0 for details.

You can change transceivers while the Switch is operating. You can use different transceivers to connect to Ethernet switches with different types of fiber-optic connectors.

- Type: SFP connection interface
- Connection speed: 1 Gigabit per second (Gbps)

**To avoid possible eye injury, do not look into an operating fiber-optic module's connectors.**

### 3.1.2.1 Transceiver Installation

Use the following steps to install a transceiver.

- 1 Insert the transceiver into the slot with the exposed section of PCB board facing down.

**Figure 18** Transceiver Installation Example

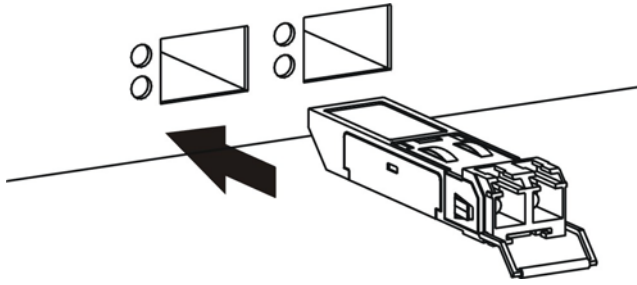

- 2 Press the transceiver firmly until it clicks into place.
- 3 The Switch automatically detects the installed transceiver. Check the LEDs to verify that it is functioning properly.

**Figure 19** Installed Transceiver

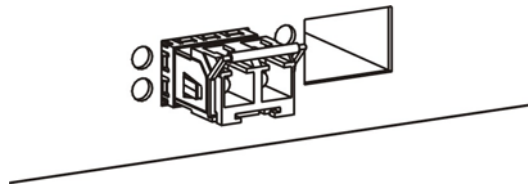

### 3.1.2.2 Transceiver Removal

Use the following steps to remove a transceiver.

- 1 Open the transceiver's latch (latch styles vary).

**Figure 20** Opening the Transceiver's Latch Example

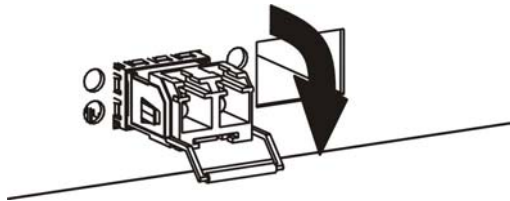

- 2 Pull the transceiver out of the slot.

**Figure 21** Transceiver Removal Example

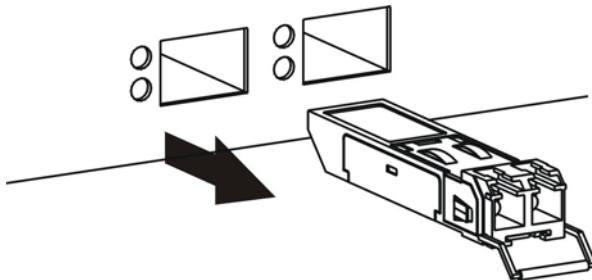

## 3.2 Rear Panel

The following figures show the rear panels of the Switch.

**Figure 22** Rear Panel: GS1900-8



**Figure 23** Rear Panel: GS1900-8HP

Revision A1



Revision B1



**Figure 24** Rear Panel: GS1900-10HP



**Figure 25** Rear Panel: GS1900-16



**Figure 26** Rear Panel: GS1900-24E



**Figure 27** Rear Panel: GS1900-24



**Figure 28** Rear Panel: GS1900-24HP



**Figure 29** Rear Panel: GS1900-48



**Figure 30** Rear Panel: GS1900-48HP



## 3.2.1 Power Connection

Make sure you are using the correct power source and that no objects obstruct the airflow of the fans.

The Switch uses two power supply modules, one of which is redundant, so if one power module fails the system can operate on the remaining module.

### Rear Panel Power Connection

Connect one end of the supplied power cord or power adaptor to the power receptacle on the back of the Switch and the other end to the appropriate power source.

For Switches with a power switch (see [Table 1 on page 16](#)), use the **POWER ON/OFF** switch to have the Switch power on or off.

### Connecting the Power

Use the following procedures to connect the Switch to a power source after you have installed it in a rack.

Note: Use the included power cord for the AC power connection.

- 1 Connect the female end of the power cord to the AC power socket.
- 2 Connect the other end of the cord to a power outlet.

### Disconnecting the Power

The power input connectors can be disconnected from the power source individually.

- 1 Disconnect the power cord from the power outlet.
- 2 Disconnect the power cord from the AC power socket.

## 3.3 LEDs

After you connect the power to the Switch, view the LEDs to ensure proper functioning of the Switch and as an aid in troubleshooting.

Table 3 LED Descriptions

LED	COLOR	STATUS	DESCRIPTION
PWR	Green	On	The system is turned on.
		Off	The system is off or has failed.
SYS	Green	On	The system is on and functioning properly.
		Blinking	The system is rebooting and performing self-diagnostic tests.
		Off	The power is off or the system is not ready/malfunctioning.
Ethernet Ports			
LNK/ACT	Green	Blinking	The system is transmitting/receiving to/from a 100/1000 Mbps Ethernet network.
		On	The link to a 100/1000 Mbps Ethernet network is up.
		Off	The link to an Ethernet network is down.
PoE (see <a href="#">Section 1.1 on page 16</a> )	Green	On	Power is supplied to all PoE Ethernet ports.
		Off	There is no power supply.
1G SFP Slots (Fiber Ports - see <a href="#">Section 1.1 on page 16</a> )			
LNK/ACT	Green	Blinking	The system is transmitting/receiving to/from a 100/1000 Mbps Fiber network.
		On	The link to a 100/1000 Mbps Fiber network is up.
		Off	The link to a Fiber network is down.

Table 4 LED Descriptions (GS1900-8HP (Revision B1) and GS1900-10HP Only)

LED	COLOR	STATUS	DESCRIPTION
PWR	Green	On	The system is turned on.
		Off	The system is off or has failed.
SYS	Green	On	The system is on and functioning properly.
		Blinking	The system is rebooting.
	Red	On	There is a system error.

Table 4 LED Descriptions (continued)(GS1900-8HP (Revision B1) and GS1900-10HP Only)

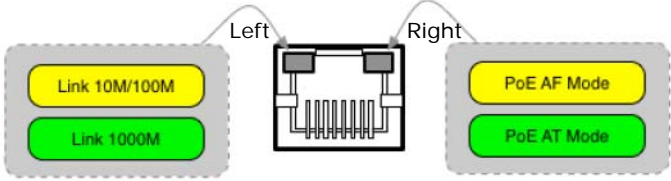
LED	COLOR	STATUS	DESCRIPTION
PoE 10/100/1000Base-T Ports (1-8), 2 LEDs per port			
			
Right	Amber	On	The port is in PoE AF mode. That is, the Switch is following the IEEE 802.3af standard to supply power to this port.
	Green	On	The port is in PoE AT mode. That is, the Switch is following the IEEE 802.3at standard to supply power to this port.
		Off	Power is not supplied to this port.
Left	Amber	On	The link to a 10/100 Mbps Ethernet network is up.
		Blinking	The system is transmitting/receiving to/from a 100/1000 Mbps Fiber network.
	Green	On	The link to a 1 Gbps Ethernet network is up.
		Blinking	The system is transmitting/receiving to/from 1 Gbps Mbps Ethernet network.

LED Descriptions for SFP Port (GS1100-10HP and GS1900-10HP Only)

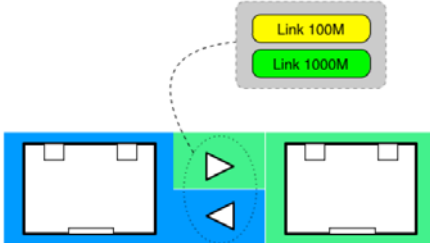
LED	COLOR	STATUS	DESCRIPTION
Two arrow LEDs for 1 G SFP Slots (Fiber Ports)			
			
right/left arrows	Amber	On	The link to a 100 Mbps Fiber network is up.
		Blinking	The system is transmitting/receiving to/from a 100 Mbps Fiber network.
	Green	On	The link to a 1 Gbps Fiber network is up.
		Blinking	The system is transmitting/receiving to/from 1 Gbps Mbps Fiber network.

### 3.4 Reset to Factory Defaults

If you forget your password or cannot access the Web Configurator, you will need to use the **RESET** button at the front of the device to reload the factory-default configuration file. This means that you will lose all configurations that you had previously and the default Switch IP address, user name and password will be reset to 192.168.1.1, admin and 1234 respectively.

If you backed up an earlier configuration file as advised in [Section 1.3 on page 19](#), you will not have to totally re-configure the Switch after resetting. You can simply restore your last configuration.



Follow the steps below to reset the Switch back to factory defaults.

- 1** Make sure the **SYS** LED is steady green (not blinking). Use a pointed instrument such as a pin to access the **RESET** button on the front of the Switch as shown in [Section 3.1 on page 25](#).
- 2** Press the button for six seconds until the **SYS** LED begins to blink and then release it. Wait for the Switch to restart (the **SYS** LED will be steady green again). This takes up to two minutes.

Note: If you want to access the Switch web configurator again, you may need to change the IP address of your computer to be in the same subnet as that of the default Switch IP address (192.168.1.1).

# CHAPTER 4

## ZON Utility

This chapter describes the screens for ZON Utility.

### 4.1 Zyxel One Network (ZON) Utility Screen

ZON Utility is a program designed to help you deploy and manage a network more efficiently. It detects devices automatically and allows you to do basic settings on devices in the network without having to be near it.

The ZON Utility issues requests via Zyxel Discovery Protocol (ZDP) and in response to the query, the device responds back with basic information including IP address, firmware version, location, system and model name in the same broadcast domain. The information is then displayed in the ZON Utility screen and you can perform tasks like basic configuration of the devices and batch firmware upgrade in it. You can download the ZON Utility at [www.zyxel.com](http://www.zyxel.com) and install it on a PC.

The following figure shows the ZON Utility screen.

Figure 31 ZON Utility Screen

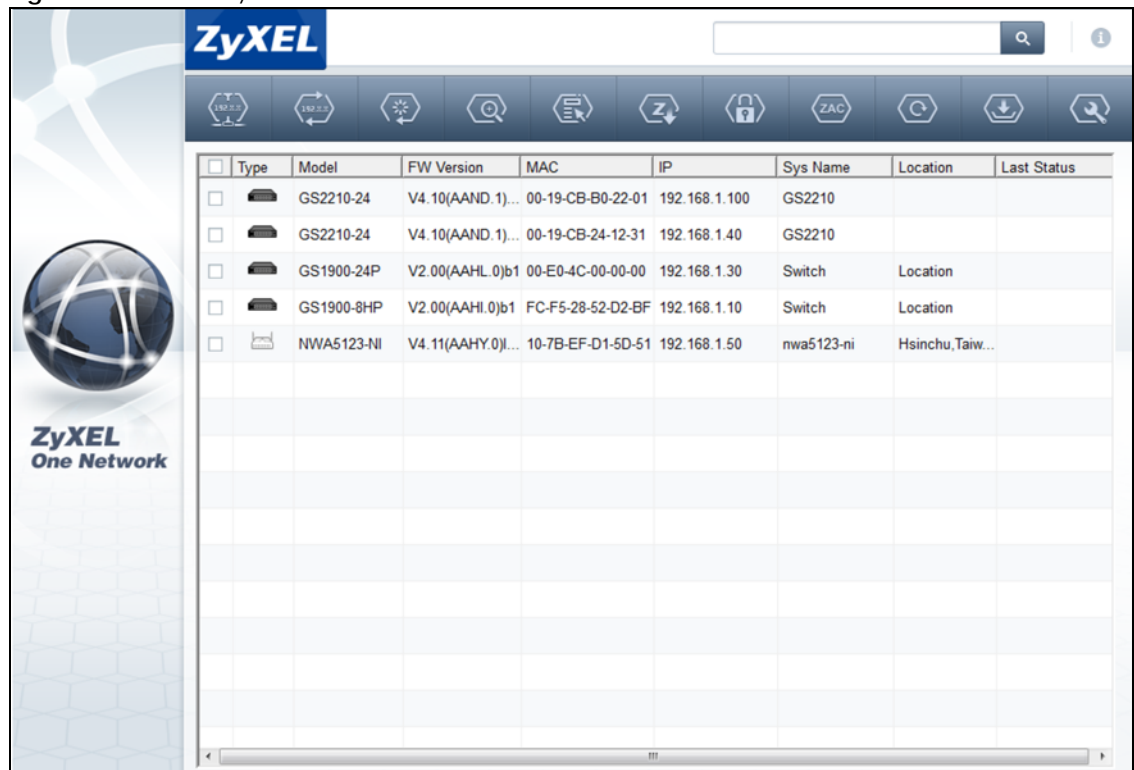

The screenshot shows the ZON Utility interface. At the top, there is a ZyXEL logo and a search bar. Below the logo is a navigation bar with several icons. The main area contains a table with the following data:

<input type="checkbox"/>	Type	Model	FW Version	MAC	IP	Sys Name	Location	Last Status
<input type="checkbox"/>		GS2210-24	V4.10(AAND.1)...	00-19-CB-B0-22-01	192.168.1.100	GS2210		
<input type="checkbox"/>		GS2210-24	V4.10(AAND.1)...	00-19-CB-24-12-31	192.168.1.40	GS2210		
<input type="checkbox"/>		GS1900-24P	V2.00(AAHL.0)b1	00-E0-4C-00-00-00	192.168.1.30	Switch	Location	
<input type="checkbox"/>		GS1900-8HP	V2.00(AAHL.0)b1	FC-F5-28-52-D2-BF	192.168.1.10	Switch	Location	
<input type="checkbox"/>		NWA5123-NI	V4.11(AAHY.0)...	10-7B-EF-D1-5D-51	192.168.1.50	nwa5123-ni	Hsinchu,Taiw...	



# CHAPTER 5

## The Web Configurator

### 5.1 Overview

The Switch **Web Configurator** allows easy management using an Internet browser.

In order to use the Web Configurator, you must:

- Use Internet Explorer 7.0 and later or Firefox 1.5 and later
- Allow pop-up windows
- Enable JavaScript (enabled by default)
- Enable Java permissions (enabled by default)
- Enable cookies

The recommended screen resolution is 1024 x 768 pixels and higher.

### 5.2 Access

- 1 Make sure your Switch hardware is properly connected. See the Quick Start Guide.
- 2 Browse to <https://192.168.1.1>. The **Login** screen appears.

**Figure 32** The Login Screen

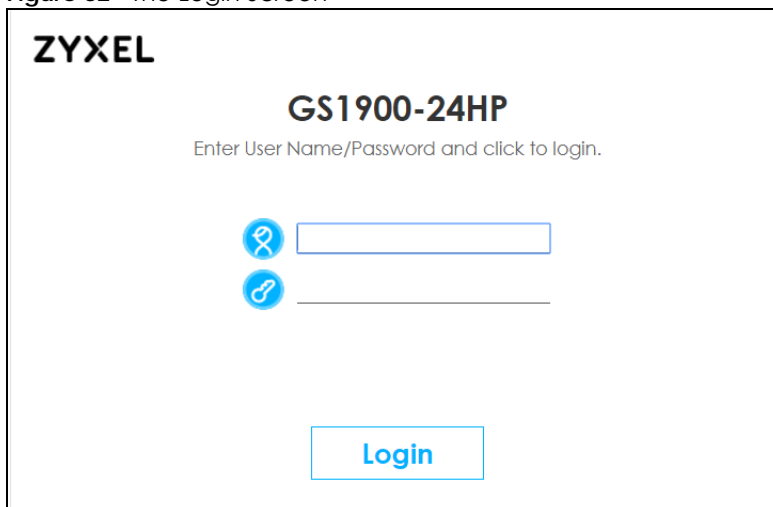

- 3 Enter the user name (default: "admin") and password (default: "1234").
- 4 Click **Login**. If you logged in using the default user name and password, getting start appears. The **Getting Start** screen appears every time you log in using the default user name and default password.

- 5 If you didn't change the default administrator password and/or SNMP community values, a warning screen displays each time you log into the web configurator. Click **Password / SNMP** to open a screen where you can change the administrator and SNMP passwords simultaneously. Otherwise, click Ignore to close it.

**Figure 33** Web Configurator: Warning

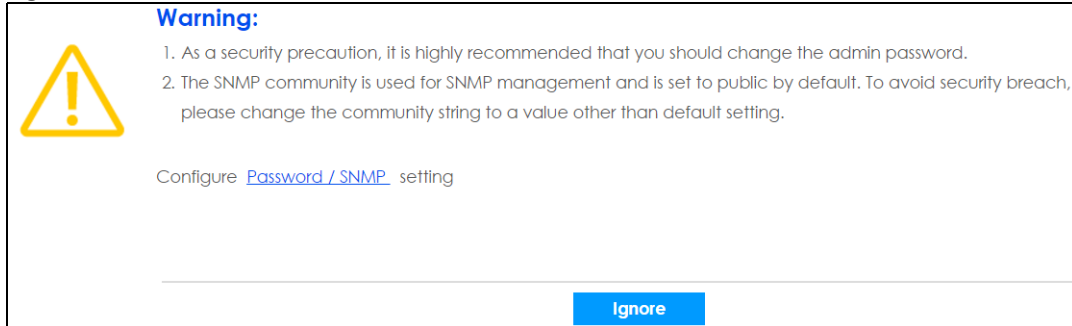

**Warning:**

1. As a security precaution, it is highly recommended that you should change the admin password.
2. The SNMP community is used for SNMP management and is set to public by default. To avoid security breach, please change the community string to a value other than default setting.

Configure [Password / SNMP](#) setting

**Ignore**

**Figure 34** Web Configurator: Password

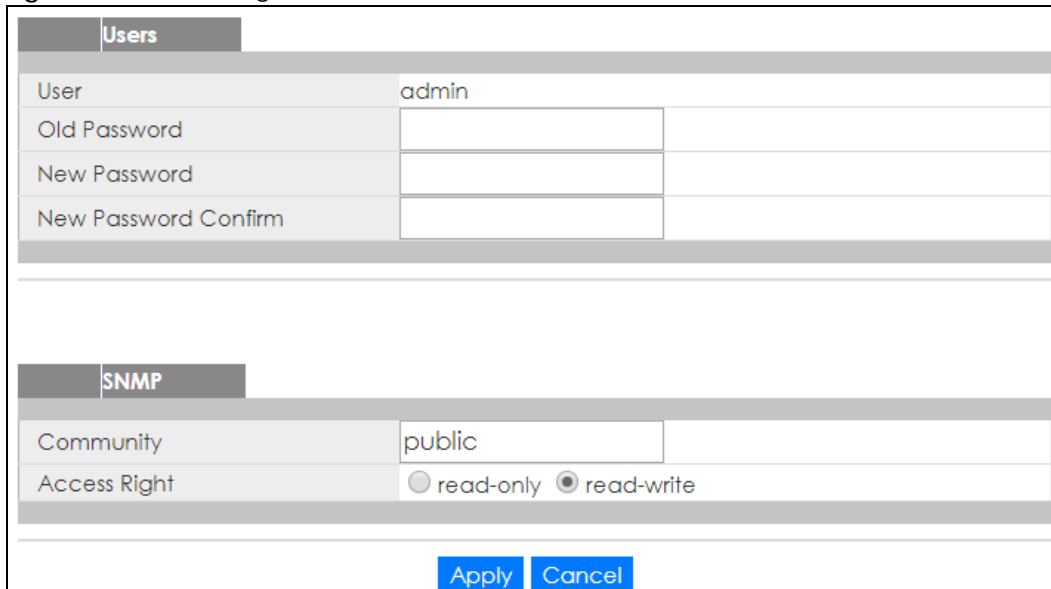

**Users**

User: admin

Old Password:

New Password:

New Password Confirm:

**SNMP**

Community: public

Access Right:  read-only  read-write

**Apply** **Cancel**

Change the default administrator and/or SNMP passwords, and then click **Apply** to save your changes.

**Table 5** Web Configurator: Password/SNMP

LABEL	DESCRIPTION
User	This is the default administrator account with the "admin" user name. You cannot change the default administrator user name. Only the administrator has read/write access.
Old Password	Type the existing system password ( <b>1234</b> is the default password when shipped).
New Password	Enter your new system password.
New Password Confirm	Retype your new system password for confirmation
SNMP	Use this section to specify the SNMP community (password) and access right values.
Community	Enter a string identifying the community name that this entry should belong to. The allowed string length is 1 to 20, and the allowed content is ASCII characters from 33 to 126.
Access Right	Select the access mode for this entry. The possible values are <b>Read-Only</b> and <b>Read-Write</b> .

Table 5 Web Configurator: Password/SNMP (continued)

LABEL	DESCRIPTION
Apply	Click <b>Apply</b> to save your changes to the Switch's run-time memory. The Switch loses these changes if it is turned off or loses power, so use the <b>Save</b> link on the top navigation panel to save your changes to the non-volatile memory when you are done configuring.
Cancel	Click <b>Cancel</b> to begin configuring this screen afresh.

## 5.3 Navigating the Web Configurator

The following summarizes how to navigate the web configurator from the **Getting Start** screen. This guide uses the GS1900-10HP screens as an example. The screens may vary slightly for different models.

Figure 35 The Web Configurator's Main Screen

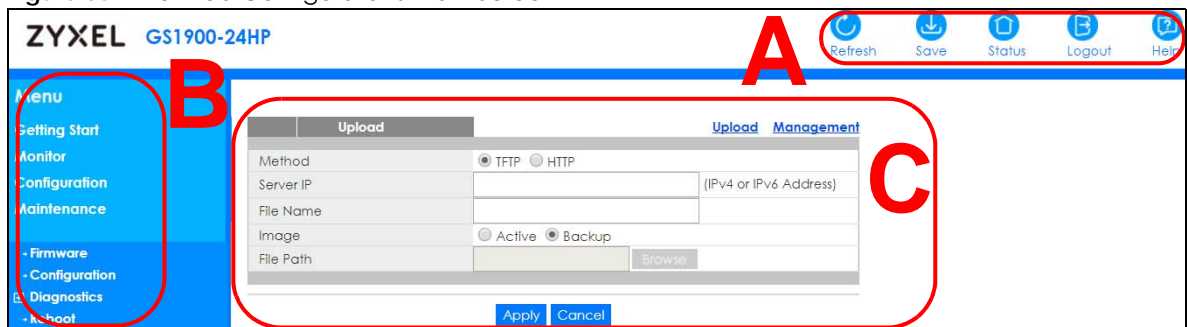

The Web Configurator's main screen is divided into these parts:

- A - Title Bar
- B - Navigation Panel
- C - Main Window

### 5.3.1 Title Bar

The title bar provides some useful links that always appear over the screens below, regardless of how deep into the Web Configurator you navigate.

Figure 36 Title Bar



The icons provide the following functions.

Table 6 Title Bar: Web Configurator Icons

LABEL	DESCRIPTION
Refresh	Click <b>Refresh</b> to reload the page.
Save	Click this to apply your changes to the Switch's run-time memory. The Switch loses these changes if it is turned off or loses power, so use the <b>Save</b> link on the top navigation panel to save your changes to the non-volatile memory when you are done configuring.
Status	Click this to display basic information about the Switch.

Table 6 Title Bar: Web Configurator Icons (continued)

LABEL	DESCRIPTION
Logout	Click this to log out of the Web Configurator.
Help	Click this to open the help page for the current screen.

Click **Logout** in a screen to exit the web configurator. You have to log in with your password again after you log out. This is recommended after you finish a management session for security reasons.

## 5.3.2 Navigation Panel

Use the menu items on the navigation panel to open screens to configure Switch features. The following sections introduce the Switch's navigation panel menus and their screens.

Figure 37 Navigation Panel

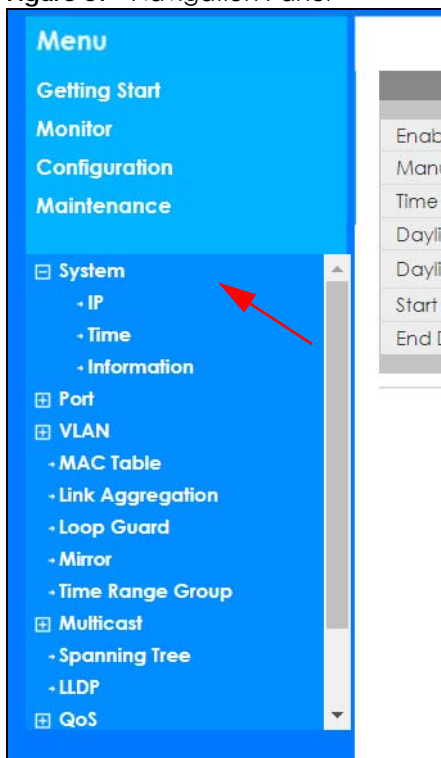

### Getting Start

Getting Start displays general device information, system status, system resource usage, and interface status.

For details on Getting Start features, see [Chapter 6 on page 45](#).

## Monitor Menu

The monitor menu screens display status and statistics information.

Table 7 Monitor Menu Screens Summary

FOLDER OR LINK	TAB	FUNCTION
System		This link takes you to a screen where you can see general identification information for the Switch.
IP	IPv4	This link takes you to a screen where you can see an IPv4 interface and the IPv4 settings on the Switch.
	IPv6	This link takes you to a screen where you can see an IPv6 interface and the IPv6 settings on the Switch.
Information		This link takes you to a screen that displays general system information: system name, system location, and system contact.
Port		This link takes you to screens where you can see speed, flow control and priority settings for individual Switch ports.
Port	Status	Displays status settings for individual Switch ports.
	Port Counters	Displays interface, port 1 interface mib counters, port 1 etherlike mib counters, port 1 RMON mib counters settings for individual Switch ports.
	Bandwidth Utilization	Displays port bandwidth utilization settings for individual Switch ports.
PoE		Displays PoE status.
Bandwidth Management		Displays egress global burst and port rate for individual Switch ports.
Storm Control		This link takes you to a screen that displays broadcast filters.
VLAN		This link takes you to screens where you can see port-based or 802.1Q VLAN (depending on what you configured in the Switch Setup menu). You can also see a protocol based VLAN or a subnet based VLAN in these screens.
VLAN	VLAN	Displays VLAN settings.
	Port	Displays port settings.
	VLAN Port	Displays VLAN port settings.
Guest VLAN		Displays global and port settings.
Voice VLAN		Displays global and port settings.
MAC Table		This link takes you to a screen where you can view the MAC address and VLAN ID of a device attach to a port. You can also view what kind of MAC address it is.
Link Aggregation		This link takes you to screen where you can view aggregate physical links to form one logical, higher-bandwidth link.
Loop Guard		This link takes you to a screen where you can view protection against network loops that occur on the edge of your network.
Multicast		This link takes you to screen where you can view various multicast features, IGMP snooping and create multicast VLANs.
IGMP	VLAN	Displays VLAN settings.
	Statistics	Displays statistics settings.
	Group	Displays group settings.
	Router	Displays router settings.



Table 7 Monitor Menu Screens Summary (continued)

FOLDER OR LINK	TAB	FUNCTION
Spanning Tree		This link takes you to screens where you can view CIST, MST, STP preventing network loops.
	CIST	Displays CIST instance status.
	CIST Port	Displays CIST port status.
	MST	Displays MST instance status.
	MST Port	Displays MST port status.
	STP Statistics	Displays STP statistics.
LLDP		Displays statistics, remote information, and overloading.
	Statistics	Displays LLDP global and port statistics.
	Remote Information	Displays remote device information.
	Overloading	Displays port overloading information.
Security		Displays port security and 802.1X settings.
Port Security		Displays global and port settings.
802.1X	Port	Displays 802.1X port settings.
	Authenticated Hosts	Displays authenticated hosts table.
Management		Displays syslog and error disable.
Syslog		Displays logging filter select and show system log.
Error Disable		Displays global and port settings.

## Configuration Menu

Use the configuration menu screens to configure the Switch's features.

Table 8 Configuration Menu Screens Summary

FOLDER OR LINK	TAB	FUNCTION
System		This link takes you to a screen where you can configure general identification information and time settings for the Switch.
IP	IPv4	This link takes you to a screen where you can enable an IPv4 interface and configure the IPv4 settings on the Switch.
	IPv6	This link takes you to a screen where you can enable an IPv6 interface and configure the IPv6 settings on the Switch.
Time	System Time	Configure time of system.
	SNTP Server	Configure SNTP server settings.
Information		This link takes you to a screen that configures general system information: system name, system location, and system contact.
Port		This link takes you to screens where you can configure speed, flow control and priority settings for individual Switch ports.
Port		Configure port settings for individual Switch ports.
EEE		Configure EEE settings for individual Switch ports.
PoE	Global	This link takes you to a screen where you can configure the global settings for the Switch to supply power over Ethernet (PoE).
	Port	This link takes you to a screen where you can configure port PoE settings.

Table 8 Configuration Menu Screens Summary (continued)

FOLDER OR LINK	TAB	FUNCTION
Bandwidth Management		Configure egress global burst and port rate.
Storm Control		Configure port settings.
VLAN		This link takes you to screens where you can configure VLAN, guest VLAN, and voice VLAN settings.
VLAN	VLAN	Configure VLAN settings.
	Port	Configure port settings.
	VLAN Port	Configure VLAN port settings.
Guest VLAN	Global	Configure global settings.
	Port	Configure port settings.
Voice VLAN	Global	Configure global settings.
	OUI	Configure OUI settings.
	Port	Configure port settings.
MAC Table		This link takes you to a screen where you can configure the MAC address and VLAN ID of a device attach to a port. You can also configure what kind of MAC address it is.
	Static MAC	This link takes you to screens where you can configure static MAC addresses for a port. These static MAC addresses do not age out.
	Filtering MAC	This link takes you to a screen to set up filtering rules.
	Dynamic Age	Configure dynamic learned and MAC address information.
Link Aggregation		This link takes you to screen where you can logically aggregate physical links to form one logical, higher-bandwidth link.
	Global	Configure global settings.
	LAG Management	Configure LAG management settings.
	LAG Port	Configure LAG port settings.
	LACP Port	Configure LACP port settings.
Loop Guard		This link takes you to a screen where you can configure protection against network loops that occur on the edge of your network.
	Global	Configure global settings.
	Port	Configure port settings.
Mirror		This link takes you to screens where you can copy traffic from one port or ports to another port. Thus, allowing you to examine the traffic from the first port without interference.
Time Range Group		This link takes you to a screen where you can define different schedules.
Multicast		This link takes you to screen where you can configure various multicast features, IGMP snooping and create multicast VLANs.
IGMP	Global	Configure global settings.
	VLAN	Configure Vlan settings.
	Router Port	Configure router port settings.
	Profile	Configure profile settings.
	Throttling	Configure throttling settings.

Table 8 Configuration Menu Screens Summary (continued)

FOLDER OR LINK	TAB	FUNCTION
Spanning Tree		This link takes you to screens where you can configure the RSTP/ MRSTP/MSTP to prevent network loops.
	Global	Configure global settings.
	STP Port	Configure STP port settings.
	CIST	Configure CIST settings.
	CIST Port	Configure CIST port settings.
	MST	Configure MST settings.
	MST Port	Configure MST port settings.
LLDP		Configure global, port, local information, MED network policy, and MED port settings.
	Global	Configure global settings.
	Port	Configure port settings.
	Local Information	Configure local information settings.
	MED Network Policy	Configure MED network policy settings.
	MED Port	Configure MED port settings.
QoS		Configure general and trust mode settings.
General	Port	Configure port settings.
	Queue	This link takes you to a screen where you can configure queuing with associated queue weights for each port.
	CoS Mapping	Configure CoS mapping settings.
	DSCP Mapping	Configure DSCP mapping settings.
	IP Precedence Mapping	Configure IP precedence mapping settings.
Trust Mode	Global	Configure global settings.
	Port	Configure port settings.
Security		Configure port security, protected port, 802.1X and DoS settings.
Port Security	Global	Configure global settings.
	Port	Configure port settings.
Protected Port		Configure protected port settings.
802.1X	Global	Configure global settings.
	Port	Configure port settings.
DoS	Global	Configure global settings.
	Port	Configure port settings.
AAA		This link takes you to a screen where you can view authentication, authorization and accounting services via external servers. The external servers can be either RADIUS (Remote Authentication Dial-In User Service) or TACACS+ (Terminal Access Controller Access-Control System Plus).
Auth Method		Configure auth method settings.
RADIUS		Configure RADIUS settings.
TACACS+		Configure TACACS+ settings.
Management		Configure syslog, SNMP, error disable, HTTP/HTTPS, users and remote access control.

Table 8 Configuration Menu Screens Summary (continued)

FOLDER OR LINK	TAB	FUNCTION
Syslog	Global	Configure global settings.
	Local	Configure local settings.
	Remote	Configure remote settings.
SNMP	Global	Configure global settings.
	Community	Configure community settings.
	Group	Configure group settings.
	User	Configure users settings.
	Trap	Configure trap settings.
	Trap Destination	Configure trap destination settings.
Error Disable		This link takes you to a screen where you can configure CPU protection and error disable recovery.
HTTP/HTTPS	HTTP	Configure HTTP settings.
	HTTPS	Configure HTTPS settings.
Users		Configure users settings.
Remote Access Control		This link takes you to a screen where you can configure global and profile settings.

## Maintenance Menu

Use the maintenance menu screens to manage configuration and firmware files, run diagnostics, and reboot or shut down the Switch.

Table 9 Maintenance Menu Screens Summary

FOLDER OR LINK	TAB	FUNCTION
Firmware	Upload	Manage upload settings.
	Management	Manage dual image and images information.
Configuration	Backup	Manage backup configuration.
	Restore	Manage restore configuration.
	Management	Manage configuration settings.
	Factory Default	Restore factory defaults.
Diagnostics		This link takes you to screens where you can view system logs and can test port(s).
Port Test		Manage cable diag and test results.
PING	IPv4	Manage ping test settings.
	IPv6	Manage IPv6 ping test settings.
Trace		Manage trace route settings.
Reboot		Reset the system.

# CHAPTER 6

# Getting Start

## 6.1 Overview

Use the **Getting Start** screens to check status information about the Switch.

### 6.1.1 What You Can Do in this Chapter

- The main **Getting Start** screen (Section 6.2 on page 45) displays the Switch's general device information, system status, system resource usage, and interface status. You can also display other status screens for more information.

## 6.2 Getting Start

This screen is the first thing you see when you log into the Switch. It also appears every time you click the **Getting Start** icon in the navigation panel. The **Getting Start** displays general device information, system status, system resource usage, and interface status in widgets.

Figure 38 Getting Start

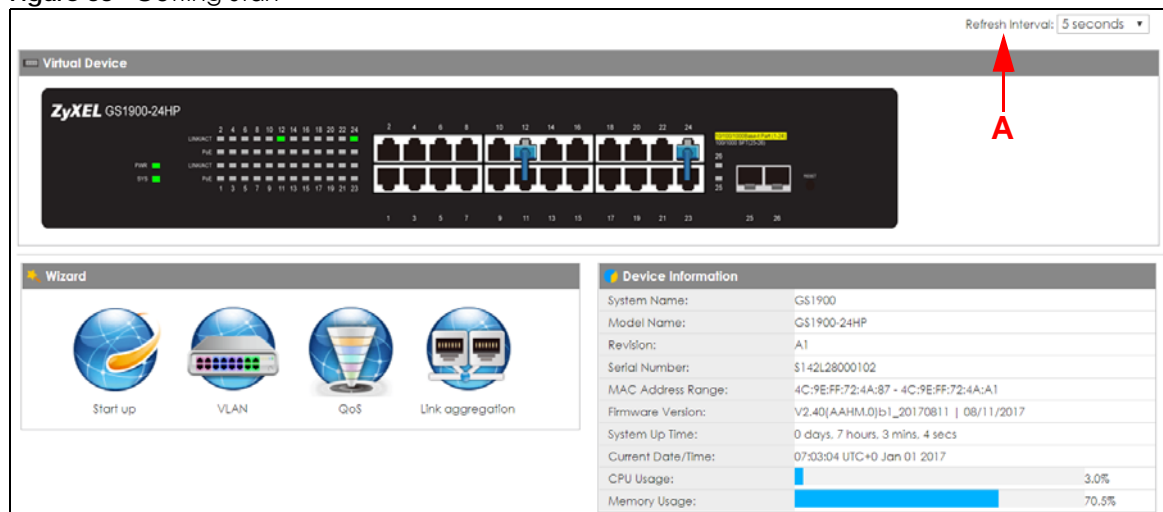

The following table describes the labels in this screen.

Table 10 Getting Start

LABEL	DESCRIPTION
Refresh Interval (A)	Use the drop-box to select: None, 5 seconds, 10 seconds, 15 seconds, 20 seconds, 25 seconds, or 30 seconds.
Virtual Device	Displays an image of the Switch.

Table 10 Getting Start (continued)

LABEL	DESCRIPTION
Wizard	Displays the following links: Start up, VLAN, QoS, and link aggregation.
Device Information	
System Name	This field displays the name used to identify the Switch on any network.
Model Name	This field displays the model name of this Switch.
Revision	This field displays the hardware revision number of this Switch.
Serial Number	This field displays the serial number of this Switch.
MAC Address Range	This field displays the MAC addresses used by the Switch. Each physical port or wireless radio has one MAC address. The first MAC address is assigned to the Ethernet LAN port, the second MAC address is assigned to the first radio, and so on.
Firmware Version	This field displays the version number and date of the firmware the Switch is currently running.
System Up Time	This field displays how long the Switch has been running since it last restarted or was turned on.
Current Date/Time	This field displays the current date and time in the Switch. The format is hh:mm:ss yyyy-mm-dd.
CPU Usage	This field displays the Switch's recent CPU usage.
Memory Usage	This field displays the Switch's recent memory usage.

## 6.2.1 Wizard

Wizard displays start up, VLAN, QoS, and link aggregation.

For details on Wizard features, see system [Chapter 7 on page 56](#), VLAN [Chapter 9 on page 68](#), QoS [Chapter 29 on page 182](#), and link aggregation [Chapter 11 on page 77](#).

### Start up

In start up, you can set up IP/DNS, set up your username/password, and view finished results.

In order to set up your IP/DNS, please do the following. Click **Getting Start > Start up > 1 Step 1 Set up IP** to access this screen.

Figure 39 Getting Start &gt; Start up &gt; 1 Step 1 Set up IP

**1 Step 1**  
Set up IP

**2 Step 2**  
Set up user name/password

**3 Step 3**  
Finish

**Step 1 Set up IP**

Host Name :

IP Address :

Subnet Mask :

Gateway :

DNS :

NTP(Network Time Protocol) :

Previous Next Finish

Each field is described in the following table.

Table 11 Getting Start &gt; Start up &gt; 1 Step 1 Set up IP

LABEL	DESCRIPTION
Host Name	This field displays a host name.
IP Address	The Switch needs an IP address for it to be managed over the network. The factory default IP address is 192.168.1.1.
Subnet Mask	The subnet mask specifies the network number portion of an IP address. The factory default subnet mask is 255.255.255.0.
Gateway	Type the IP address of the default outgoing gateway in dotted decimal notation, for example 192.168.1.254.
DNS	DNS (Domain Name System) is for mapping a domain name to its corresponding IP address and vice versa. Enter a domain name server IP address in order to be able to use a domain name instead of an IP address.
NTP(Network Time Protocol)	This field displays the NTP time servers from which the Switch gets the time and date.
Next	Click <b>Next</b> to show the next screen.

After clicking **Next**, the set up your user name screen appears.

Figure 40 Getting Start > Start up > 2 Step 2 Set up user name/password

Each field is described in the following table.

Table 12 Getting Start > Start up > 2 Step 2 Set up user name/password

LABEL	DESCRIPTION
Username	The default username is <b>admin</b> and associated default password is <b>1234</b> .
Password	The default username is <b>admin</b> and associated default password is <b>1234</b> .
Previous	Click <b>Previous</b> to show the previous screen.
Next	Click <b>Next</b> to show the next screen.

After clicking **Next**, the finish screen appears.

Figure 41 Getting Start > Start up > 3 Step 3 Finish



Each field is described in the following table.

Table 13 Getting Start > Start up > 3 Step 3 Finish

LABEL	DESCRIPTION
Host Name	This field displays a host name.
IP Address	The Switch needs an IP address for it to be managed over the network. The factory default IP address is 192.168.1.1.
Subnet Mask	The subnet mask specifies the network number portion of an IP address. The factory default subnet mask is 255.255.255.0.
Gateway	Type the IP address of the default outgoing gateway in dotted decimal notation, for example 192.168.1.254.
DNS	DNS (Domain Name System) is for mapping a domain name to its corresponding IP address and vice versa. Enter a domain name server IP address in order to be able to use a domain name instead of an IP address.
NTP(Network Time Protocol)	This field displays the NTP time servers from which the Switch gets the time and date.
Username	The default username is <b>admin</b> and associated default password is <b>1234</b> .
Password	The default username is <b>admin</b> and associated default password is <b>1234</b> .
Previous	Click <b>Previous</b> to show the previous screen.
Finish	Review the information and click <b>Finish</b> to create the task.

## VLAN

In VLAN, you can create VLAN, tag VLAN setting, and view finished results.

In order to create VLAN, please do the following. Click **Getting Start > VLAN > 1 Step 1 Create VLAN** to access this screen.

Figure 42 Getting Start > VLAN > 1 Step 1 Create VLAN

The screenshot displays a configuration interface for creating a VLAN. At the top, there are three step indicators: '1 Step 1 Creat VLAN' (highlighted in blue), '2 Step 2 Tag VLAN setting', and '3 Step 3 Finish'. Below these, the main content area is titled 'Creat VLAN'. It features two options for specifying the VLAN ID: a text input field labeled 'Create VLAN ID (1-4094):' and a dropdown menu labeled 'Edit VLAN ID:' with 'VLAN 1' selected. At the bottom of the interface, there are three buttons: 'Previous' (disabled), 'Next' (active/highlighted), and 'Finish' (disabled).

Each field is described in the following table.

Table 14 Getting Start > VLAN > 1 Step 1 Create VLAN

LABEL	DESCRIPTION
Create VLAN ID (1-4094)	Type a number between 1 and 4094 to create a VLAN ID.
Edit VLAN ID	Select from the drop-box a VLAN ID.
Next	Click <b>Next</b> to show the next screen.

After clicking Next, the tag VLAN setting screen appears.

Figure 43 Getting Start > VLAN > 2 Step 2 Tag VLAN Setting

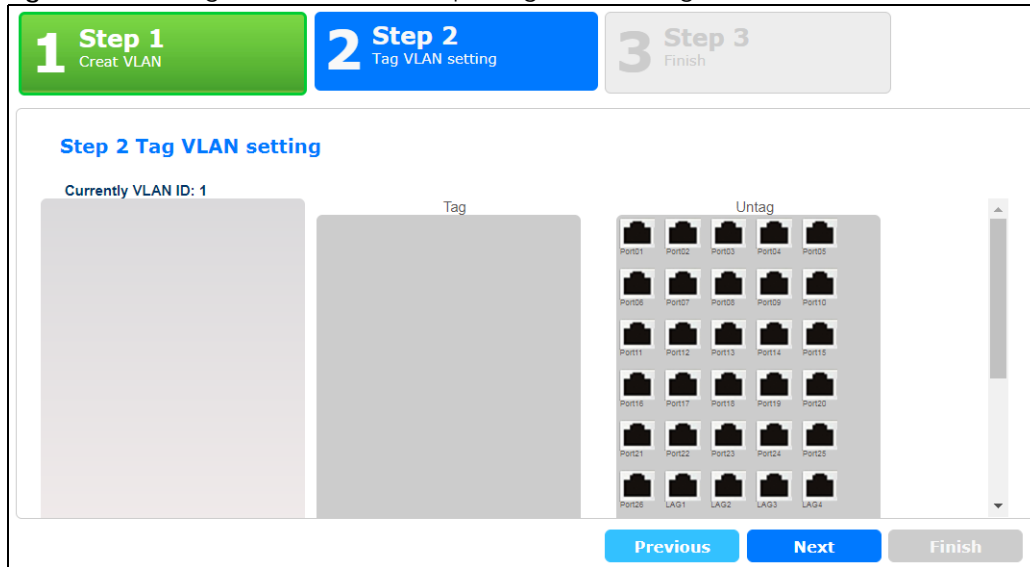

Each field is described in the following table.

Table 15 Getting Start > VLAN > 2 Step 2 Tag VLAN Setting

LABEL	DESCRIPTION
Currently VLAN ID	This field displays the VLAN identification number.
Tag	Ports belonging to the specified VLAN tag all outgoing frames transmitted.
Untag	Ports belonging to the specified VLAN don't tag all outgoing frames transmitted.
Previous	Click <b>Previous</b> to show the previous screen.
Next	Click <b>Next</b> to show the next screen.

After clicking **Next**, the finish screen appears.

Figure 44 Getting Start &gt; VLAN&gt; 3 Step 3 Finish

**1 Step 1**  
Creat VLAN

**2 Step 2**  
Tag VLAN setting

**3 Step 3**  
Finish

**Step 3 Finish**

Currently VLAN ID: 1  
Tag

Untag

Port01 Port02 Port03 Port04 Port05  
Port06 Port07 Port08 Port09 Port10  
Port11 Port12 Port13 Port14 Port15  
Port16 Port17 Port18 Port19 Port20  
Port21 Port22 Port23 Port24 Port25  
Port26 LAG1 LAG2 LAG3 LAG4

Previous Next Finish

Each field is described in the following table.

Table 16 Getting Start &gt; VLAN &gt; 3 Step 3 Finish

LABEL	DESCRIPTION
Currently VLAN ID	This field displays the VLAN identification number.
Tag	Ports belonging to the specified VLAN tag all outgoing frames transmitted.
Untag	Ports belonging to the specified VLAN don't tag all outgoing frames transmitted.
Previous	Click <b>Previous</b> to show the previous screen.
Finish	Review the information and click <b>Finish</b> to create the task.

## QoS

In QoS, you can create QoS settings, and view finished results.

In order to create QoS settings, please do the following. Click **Getting Start > QoS > 1 Step 1 QoS (Quality of Service)** to access this screen.

Figure 45 Getting Start > QoS > 1 Step 1 QoS (Quality of Service)

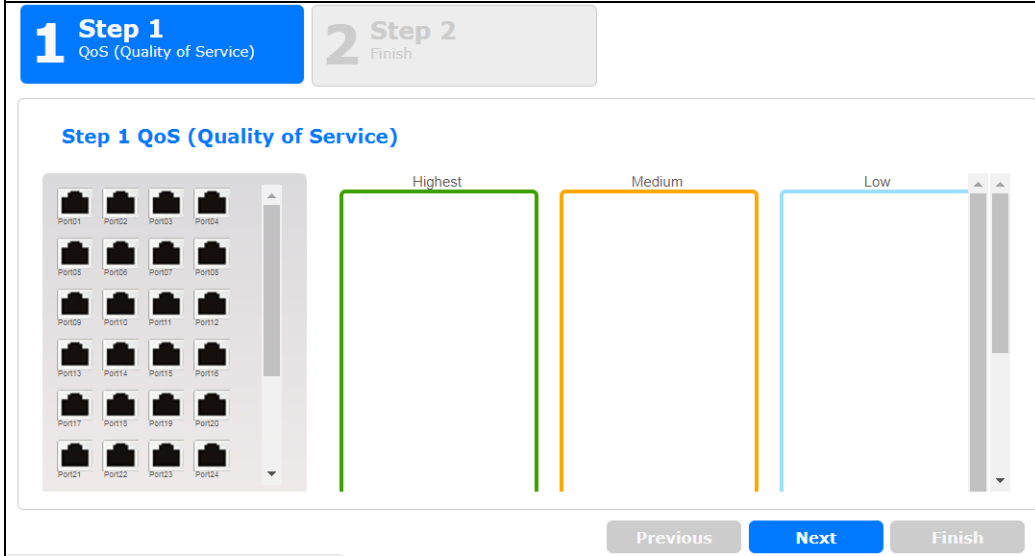

Each field is described in the following table.

Table 17 Getting Start > QoS > 1 Step 1 QoS (Quality of Service)

LABEL	DESCRIPTION
Highest	Click and drag icons located on the left to desired preference.
Medium	Click and drag icons located on the left to desired preference.
Low	Click and drag icons located on the left to desired preference.
Next	Click <b>Next</b> to show the next screen.

After clicking **Next**, the finish screen appears.

Figure 46 Getting Start > QoS > 2 Step 2 Finish

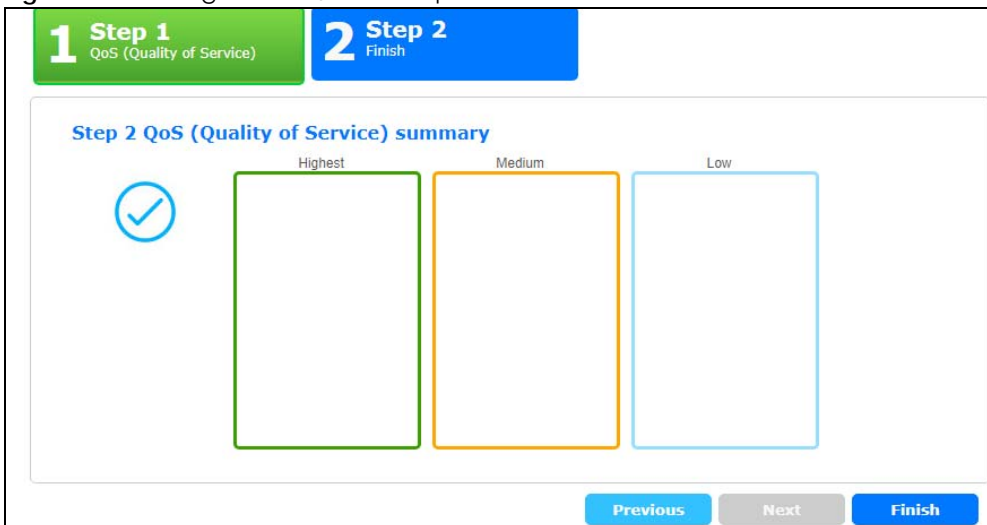

Each field is described in the following table.

Table 18 Getting Start > QoS > 2 Step 2 Finish

LABEL	DESCRIPTION
Highest	Displays summary results.
Medium	Displays summary results.
Low	Displays summary results.
Previous	Click <b>Previous</b> to show the previous screen.
Finish	Review the information and click <b>Finish</b> to create the task.

## Link aggregation

In link aggregation, you can link aggregation and view finished results.

In order to create link aggregation settings, please do the following. Click **Getting Start > Link aggregation > 1 Step 1 Link aggregation** to access this screen.

Figure 47 Getting Start > Link aggregation > 1 Step 1 Link aggregation

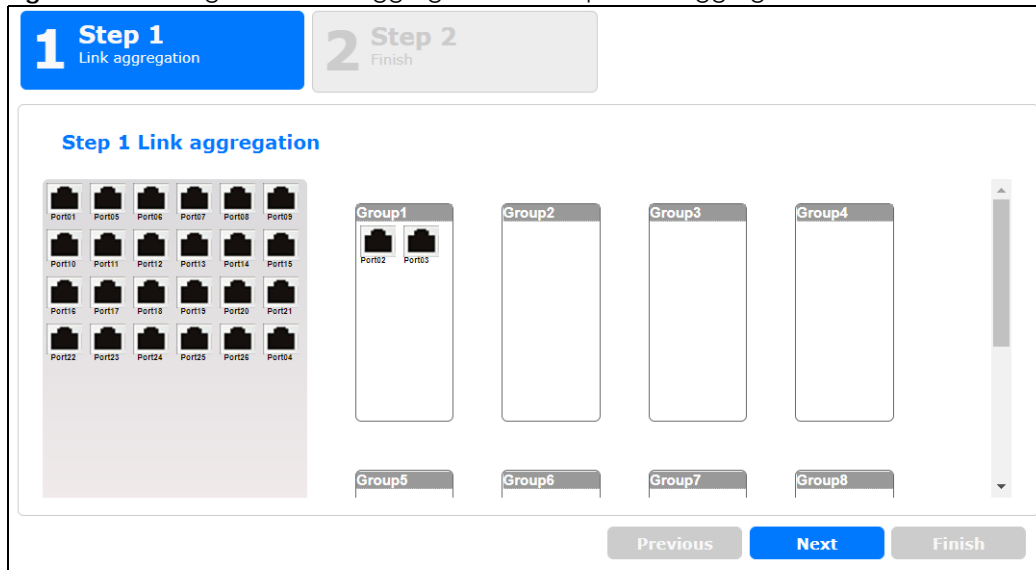

Each field is described in the following table.

Table 19 Getting Start > Link aggregation > 1 Step 1 Link aggregation

LABEL	DESCRIPTION
Group 1	Click and drag icons located on the left to desired preference.
Group 2	Click and drag icons located on the left to desired preference.
Group 3	Click and drag icons located on the left to desired preference.
Group 4	Click and drag icons located on the left to desired preference.
Group 5	Click and drag icons located on the left to desired preference.
Group 6	Click and drag icons located on the left to desired preference.
Group 7	Click and drag icons located on the left to desired preference.

Table 19 Getting Start &gt; Link aggregation &gt; 1 Step 1 Link aggregation

LABEL	DESCRIPTION
Group 8	Click and drag icons located on the left to desired preference.
Next	Click <b>Next</b> to show the next screen.

After clicking **Next**, the finish screen appears.

Figure 48 Getting Start &gt; Link aggregation &gt; 2 Step 2 Finish

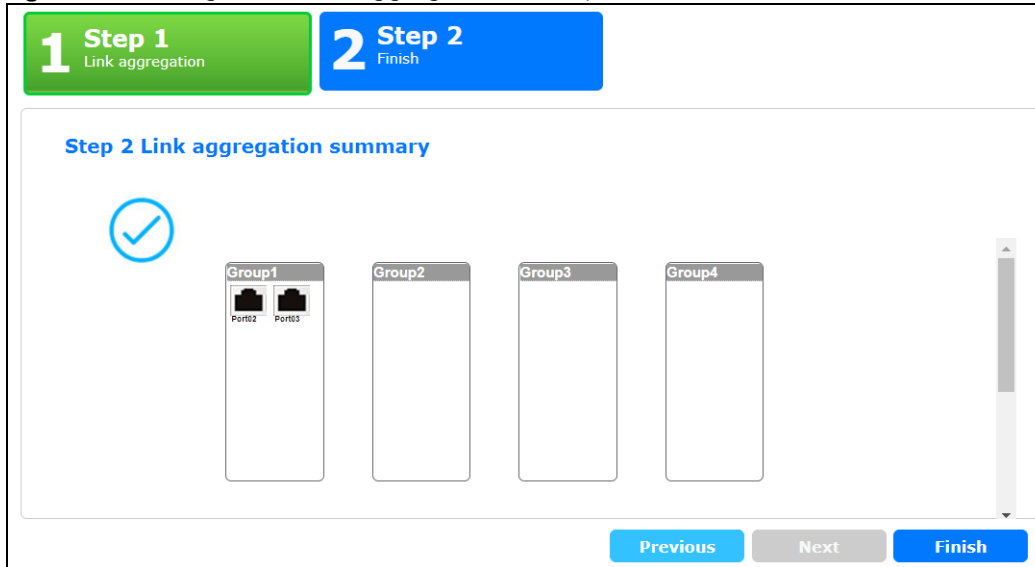

Each field is described in the following table.

Table 20 Getting Start &gt; Link aggregation &gt; 2 Step 2 Finish

LABEL	DESCRIPTION
Group 1	Displays summary results.
Group 2	Displays summary results.
Group 3	Displays summary results.
Group 4	Displays summary results.
Group 5	Displays summary results.
Group 6	Displays summary results.
Group 7	Displays summary results.
Group 8	Displays summary results.
Previous	Click <b>Previous</b> to show the previous screen.
Finish	Review the information and click <b>Finish</b> to create the task.

---

# PART II

## Technical Reference

---

# CHAPTER 7

## Monitor: System

### 7.1 Overview

This section provides information for **System** in **Monitor**. Use the **System** screens to view general Switch settings.

#### 7.1.1 What You Can Do in this Chapter

- The **IP** screen ([Section 7.2 on page 56](#)) displays IPv4 and IPv6.
- The **Information** screen ([Section 7.3 on page 57](#)) displays the system information.

### 7.2 IP

The Switch needs an IP address for it to be managed over the network. The factory default IP address is 192.168.1.1. The subnet mask specifies the network number portion of an IP address. The factory default subnet mask is 255.255.255.0.

#### 7.2.1 IPv4

Use this screen to view the Switch's IPv4 information. Click **Monitor > System > IP > IPv4** to open this screen.

Figure 49 Monitor > System > IP > IPv4

IPv4 Information		<a href="#">IPv4</a>	<a href="#">IPv6</a>
DHCP State	Disable		
IP Address	10.214.80.211		
Subnet Mask	255.255.255.0		
Gateway	0.0.0.0		
DNS Server 1	0.0.0.0		
DNS Server 2	0.0.0.0		
Management VLAN	1		

The following table describes the labels in this screen.

Table 21 Monitor > System > IP > IPv4

LABEL	DESCRIPTION
DHCP State	This field displays the state of Dynamic Host Configuration Protocol RFC 2131 and RFC 2132 (DHCP).
IP Address	This field displays IP address of the Switch in the IP domain.



Table 21 Monitor &gt; System &gt; IP &gt; IPv4 (continued)

LABEL	DESCRIPTION
Subnet Mask	This field displays the subnet mask of the Switch in the IP domain.
Gateway	This field displays the IP address of the default outgoing gateway in dotted decimal notation, for example 192.168.1.254.
DNS Server 1	DNS (Domain Name System) is for mapping a domain name to its corresponding IP address and vice versa. This field displays a domain name server IP address, enabling the use of a domain.
DNS Server 2	DNS (Domain Name System) is for mapping a domain name to its corresponding IP address and vice versa. This field displays a domain name server IP address, enabling the use of a domain.
Management VLAN	This field displays the management VLAN.

## 7.2.2 IPv6

Use this screen to view the Switch's IPv6 information. Click **Monitor > System > IP > IPv6** to open this screen.

Figure 50 Monitor &gt; System &gt; IP &gt; IPv6

IPv6 Information		IPv4	IPv6
Auto Configuration	Enable		
IPv6 Address	fe80::4e9e:ffff:fe72:4a87 / 64		
IPv6 Gateway	::		
DHCPv6 Client	Disable		

The following table describes the labels in this screen.

Table 22 Monitor &gt; System &gt; IP &gt; IPv6

LABEL	DESCRIPTION
Auto Configuration	This field displays auto configuration.
IPv6 Address	This field displays IP address of the Switch in the IP domain.
IPv6 Gateway	This field displays the IP address of the default outgoing gateway.
DHCPv6 Client	This field displays the Switch's DHCP settings when it is acting as a DHCPv6 client.

## 7.3 Information

In the navigation panel, click **Monitor > System > Information > System Information** to display the screen as shown. You can view system information.

Figure 51 Monitor &gt; System &gt; Information &gt; System Information

System Information	
System Name	GS1900
System Location	Location
System Contact	Contact

The following table describes the labels in this screen.

Table 23 Monitor > System > Information > System Information

<b>LABEL</b>	<b>DESCRIPTION</b>
System Name	This field displays the descriptive name of the Switch for identification purposes.
System Location	This field displays the geographic location of the Switch for identification purposes.
System Contact	This field displays the person in charge of the Switch for identification purposes.

# CHAPTER 8

## Monitor: Port

### 8.1 Overview

This section provides information for **Port** in **Monitor**. Use the **Port** screens to view general Switch port settings.

#### 8.1.1 What You Can Do in this Chapter

- The **Port** screen ([Section 8.2 on page 59](#)) displays status, port counters, and bandwidth utilization.
- The **PoE** screen ([Section 8.3 on page 63](#)) displays PoE.
- The **Bandwidth Management** screen ([Section 8.4 on page 65](#)) displays bandwidth control.
- The **Storm Control** screen ([Section 8.5 on page 66](#)) displays port settings of the Switch.

### 8.2 Port

Use this screen to view Switch port settings.

#### 8.2.1 Status

Use this screen to view the Switch's port statistics. Click **Monitor** > **Port** > **Port** > **Status** to access this screen.

Figure 52 Monitor > Port > Port > Status

Port	Status			Speed	Duplex	FlowCtrl Status	Type
	Port Name	State	Link Status				
1		Enable	Down	Auto	Auto	Disable	Copper
2		Enable	Down	Auto	Auto	Disable	Copper
3		Enable	Down	Auto	Auto	Disable	Copper
4		Enable	Down	Auto	Auto	Disable	Copper
5		Enable	Down	Auto	Auto	Disable	Copper
6		Enable	Down	Auto	Auto	Disable	Copper
7		Enable	Down	Auto	Auto	Disable	Copper
8		Enable	Down	Auto	Auto	Disable	Copper
21		Enable	Down	Auto	Auto	Disable	Copper
22		Enable	Up	Auto-1000M	Auto-full	Disable	Copper
23		Enable	Down	Auto	Auto	Disable	Copper
24		Enable	Up	Auto-1000M	Auto-full	Disable	Copper
25		Enable	Down	Auto	Auto	Disable	Fiber
26		Enable	Down	Auto	Auto	Disable	Fiber

Each field is described in the following table.

Table 24 Monitor > Port > Port > Status

LABEL	DESCRIPTION
Port	This is the port index number.
Port Name	A descriptive name that identifies this port.
State	This is port admin setting state.
Link Status	This field displays <b>Up</b> , <b>Down</b> or <b>NotPresent</b> . It displays <b>Up</b> when the port is linked up or <b>Down</b> when it is not. When no any physical port is binding with this group, it displays <b>NotPresent</b> .
Speed	View the speed of the Ethernet connection on this port.
Duplex	View the duplex mode of the Ethernet connection on this port.
FlowCtrl Status	A concentration of traffic on a port decreases port bandwidth and overflows buffer memory causing packet discards and frame losses. Flow Control is used to regulate transmission of signals to match the bandwidth of the receiving port.
Type	View the type on this port.

## 8.2.2 Port Counters

Use this screen to view the Switch's port counters settings. Click **Monitor > Port > Port > Port Counters** to access this screen.

Figure 53 Monitor > Port > Port > Port Counters (Port 1 Interface mib Counters)

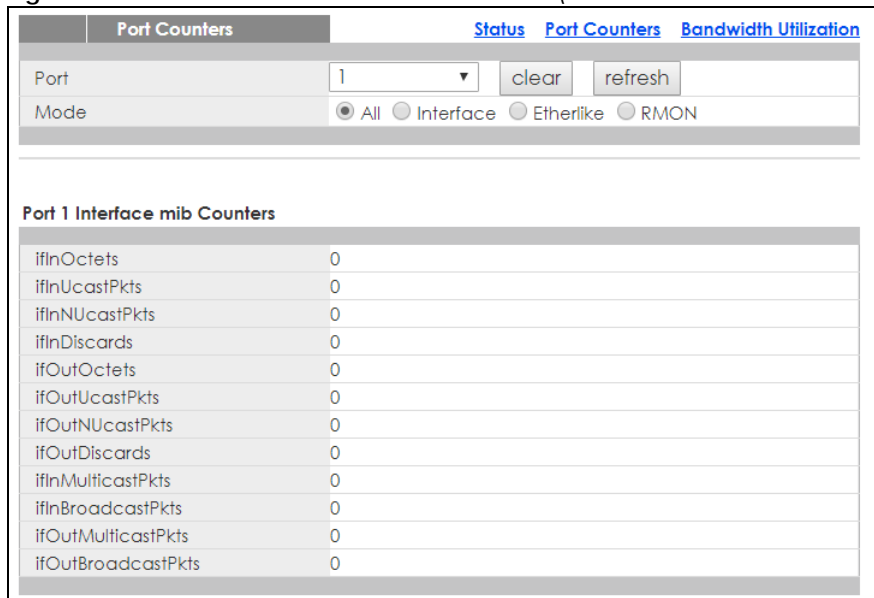

**Figure 54** Monitor > Port > Port > Port Counters (Port 1 Etherlike mib Counters)

Port 1 Etherlike mib Counters	
dot3StatsAlignmentErrors	0
dot3StatsFCSErrors	0
dot3StatsSingleCollisionFrames	0
dot3StatsMultipleCollisionFrames	0
dot3StatsDeferredTransmissions	0
dot3StatsLateCollisions	0
dot3StatsExcessiveCollisions	0
dot3StatsFrameTooLongs	0
dot3StatsSymbolErrors	0
dot3ControlInUnknownOpcodes	0
dot3InPauseFrames	0
dot3OutPauseFrames	0

**Figure 55** Monitor > Port > Port > Port Counters (Port 1 RMON mib Counters)

Port 1 RMON mib Counters	
etherStatsDropEvents	0
etherStatsOctets	0
etherStatsPkts	0
etherStatsBroadcastPkts	0
etherStatsMulticastPkts	0
etherStatsCRCAlignErrors	0
etherStatsUnderSizePkts	0
etherStatsOverSizePkts	0
etherStatsFragments	0
etherStatsJabbers	0
etherStatsCollisions	0
etherStatsPkts64Octets	0
etherStatsPkts65to127Octets	0
etherStatsPkts128to255Octets	0
etherStatsPkts256to511Octets	0
etherStatsPkts512to1023Octets	0
etherStatsPkts1024to1518Octets	0

Each field is described in the following table.

Table 25 Monitor &gt; Port &gt; Port &gt; Port Counters

LABEL	DESCRIPTION
Port Counters	
Port	This field displays the port.
Mode	This field displays the mode.
Port 1 Interface mib Counters	
ifInOctets	This field displays the ifInOctets.
ifInUcastPkts	This field displays the ifInUcastPkts.
ifInNUcastPkts	This field displays the ifInNUcastPkts..
ifInDiscards	This field displays the ifInDiscards.
ifOutOctets	This field displays the ifOutOctets.
ifOutUcastPkts	This field displays the ifOutUcastPkts.
ifOutNUcastPkts	This field displays the ifOutNUcastPkts.
ifOutDiscards	This field displays the ifOutDiscards.
ifInMulticastPkts	This field displays the ifInMulticastPkts.
ifInBroadcastPkts	This field displays the ifInBroadcastPkts.

Table 25 Monitor &gt; Port &gt; Port &gt; Port Counters (continued)

LABEL	DESCRIPTION
ifOutMulticastPkts	This field displays the ifOutMulticastPkts.
ifOutBroadcastPkts	This field displays the ifOutBroadcastPkts.
Port 1 Etherlike mib Counters	
dot3StatsAlignmentErrors	This field displays the dot3StatsAlignmentErrors.
dot3StatsFCSErrors	This field displays the dot3StatsFCSErrors.
dot3StatsSingleCollisionFrames	This field displays the dot3StatsSingleCollisionFrames.
dot3StatsMultipleCollisionFrames	This field displays the dot3StatsMultipleCollisionFrames.
dot3StatsDeferredTransmissions	This field displays the dot3StatsDeferredTransmissions.
dot3StatsLateCollisions	This field displays the dot3StatsLateCollisions.
dot3StatsExcessiveCollisions	This field displays the dot3StatsExcessiveCollisions.
dot3StatsFrameTooLongs	This field displays the dot3StatsFrameTooLongs.
dot3StatsSymbolErrors	This field displays the dot3StatsSymbolErrors.
dot3ControlInUnkownOpCodes	This field displays the dot3ControlInUnkownOpCodes.
dot3InPauseFrames	This field displays the dot3InPauseFrames.
dot3OutPauseFrames	This field displays the dot3OutPauseFrames.
Port 1 RMON mib Counters	
etherStatsDropEvents	This field displays the etherStatsDropEvents.
etherStatsOctets	This field displays the etherStatsOctets.
etherStatsPkts	This field displays the etherStatsPkts.
etherStatsBroadcastPkts	This field displays the etherStatsBroadcastPkts.
etherStatsMulticastPkts	This field displays the etherStatsMulticastPkts.
etherStatsCRCAlignErrors	This field displays the etherStatsCRCAlignErrors.
etherStatsUnderSizePkts	This field displays the etherStatsUnderSizePkts.
etherStatsOverSizePkts	This field displays the etherStatsOverSizePkts.
etherStatsFragments	This field displays the etherStatsFragments.
etherStatsJabbers	This field displays the etherStatsJabbers.
etherStatsCollisions	This field displays the etherStatsCollisions.
etherStatsPkts64Octets	This field displays the etherStatsPkts64Octets.
etherStatsPkts65to127Octets	This field displays the etherStatsPkts65to127Octets.
etherStatsPkts128to255Octets	This field displays the etherStatsPkts128to255Octets.
etherStatsPkts256to511Octets	This field displays the etherStatsPkts256to511Octets.
etherStatsPkts512to1023Octets	This field displays the etherStatsPkts512to1023Octets.
etherStatsPkts1024to1518Octets	This field displays the etherStatsPkts1024to1518Octets.

### 8.2.3 Bandwidth Utilization

Utilization is the percentage of a network's bandwidth that is currently being consumed by network traffic. Each vertical bar represents the highest utilization on a port, and can be either transmitted (Tx) traffic or received (Rx) traffic during the last time interval in seconds.

Use this screen to view the Switch's bandwidth utilization settings. Click **Monitor > Port > Port > Bandwidth Utilization** to access this screen.

Figure 56 Monitor &gt; Port &gt; Port &gt; Bandwidth Utilization



Each field is described in the following table.

Table 26 Monitor &gt; Port &gt; Port &gt; Bandwidth Utilization

LABEL	DESCRIPTION
Bandwidth Utilization	
1Gbps	This field displays the 1Gbps.
100Mbps	This field displays the 100Mbps.
10Mbps	This field displays the 10Mbps.
Link down	This field displays the link down.
Refresh period	This field displays the refresh period.
IFG	This field displays the IFG.
Tx	Transmitted (Tx) traffic during the last time interval in seconds.
Rx	Received (Rx) traffic during the time interval in seconds.

## 8.3 PoE

Note: The PoE function and the following screens are available for models ending in "HP" only.

The Switch supports both the IEEE 802.3af Power over Ethernet (PoE) and IEEE 802.3at High Power over Ethernet (PoE) standards. The Switch is Power Sourcing Equipment (PSE) because it provides a source of

power via its Ethernet ports, and each device that receives power through an Ethernet port is a Powered Device (PD).

In the figure below, the IP camera and IP phone get their power directly from the Switch. Aside from minimizing the need for cables and wires, PoE removes the hassle of trying to find a nearby electric outlet to power up devices.

**Figure 57** Powered Device Examples  
PSE

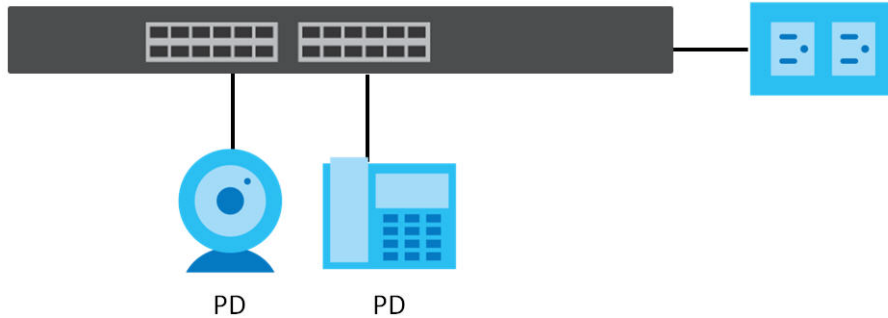

You can also set priorities so that the Switch is able to reserve and allocate power to certain PDs.

Note: The PoE devices that supply or receive power and their connected Ethernet cables must all be completely indoors.

To view the current amount of power that PDs are receiving from the Switch, click **Monitor > Port > PoE**.

**Figure 58** Monitor > Port > PoE

PoE				
PoE Mode	Total Power(W)	Consuming Power(W)	Allocated Power(W)	Remaining Power(W)
Consumption	170.0	0.0	0.0	170.0

Each field is described in the following table.

Table 27 Monitor > Port > PoE

LABEL	DESCRIPTION
PoE Mode	This field displays the power management mode used by the Switch, whether it is in <b>Classification</b> or <b>Consumption</b> mode.
Total Power(W)	This field displays the total power the Switch can provide to the connected PoE-enabled devices on the PoE ports. The total power of GS1900-10HP is 77W and GS1900-8HP is 70W.
Consuming Power(W)	This field displays the total amount of power the Switch is currently supplying to the connected PoE-enabled devices.
Allocated Power(W)	This field displays the total amount of power the Switch has reserved for PoE after negotiating with the connected PoE device(s).  <b>Consuming Power (W)</b> can be less than or equal but not more than the <b>Allocated Power (W)</b> .
Remaining Power(W)	This field displays the amount of power the Switch can still provide for PoE.  Note: The Switch must have at least 16 W of remaining power in order to supply power to a PoE device, even if the PoE device needs less than 16 W.



## 8.4 Bandwidth Management

This section shows you the maximum bandwidth using the **Bandwidth Management** screen. Bandwidth management shows the maximum allowable bandwidth for incoming and/or out-going traffic flows on a port.

### 8.4.1 Bandwidth Control

Use this screen to view the Switch's bandwidth control in egress global burst and port rate.

An egress port is an outgoing port, that is, a port through which a data packet leaves for both ports. An ingress port is an incoming port, that is, a port through which a data packet enters.

Click **Monitor > Port > Bandwidth Management > Bandwidth Control** to access this screen.

**Figure 59** Monitor > Port > Bandwidth Management > Bandwidth Control

Bandwidth Control		
Egress Global Burst	40000(Byte)	
<b>Port Rate</b>		
Port	Ingress RateLimit (Kbps)	Egress RateLimit (Kbps)
1	Disable	Disable
2	Disable	Disable
3	Disable	Disable
4	Disable	Disable
5	Disable	Disable
6	Disable	Disable
7	Disable	Disable
8	Disable	Disable
9	Disable	Disable
10	Disable	Disable
11	Disable	Disable
22	Disable	Disable
23	Disable	Disable
24	Disable	Disable
25	Disable	Disable
26	Disable	Disable

Each field is described in the following table.

**Table 28** Monitor > Port > Bandwidth Management > Bandwidth Control

LABEL	DESCRIPTION
Bandwidth Control	
Egress Global Burst	This field specifies the current egress burst size in bytes all ports.
Port Rate	View the maximum bandwidth allowed in kilobits per second (Kbps) for the traffic flow on a port.
Port	This field displays the port number.

Table 28 Monitor &gt; Port &gt; Bandwidth Management &gt; Bandwidth Control (continued)

LABEL	DESCRIPTION
Ingress RateLimit (Kbps)	View the maximum bandwidth allowed in kilobits per second (Kbps) for the incoming traffic flow on a port.
Egress RateLimit (Kbps)	View the maximum bandwidth allowed in kilobits per second (Kbps) for the out-going traffic flow on a port.

## 8.5 Storm Control

This section shows you the storm control feature.

Storm control limits the number of broadcast, multicast and unicast packets the Switch receives per second on the ports. When the maximum number of allowable broadcast, multicast and/or unicast packets is reached per second, the subsequent packets are discarded. Enabling this feature reduces broadcast, multicast and/or unicast packets in your network. You can specify limits for each packet type on each port.

Click **Monitor > Port > Storm Control** to access this screen.

Figure 60 Monitor &gt; Port &gt; Storm Control

Storm Control					
Port	State	Broadcast (pps)	Unknown Multicast (pps)	Unknown Unicast (pps)	Action
1	Disable	Disable	Disable	Disable	Drop
2	Disable	Disable	Disable	Disable	Drop
3	Disable	Disable	Disable	Disable	Drop
4	Disable	Disable	Disable	Disable	Drop
5	Disable	Disable	Disable	Disable	Drop
6	Disable	Disable	Disable	Disable	Drop
7	Disable	Disable	Disable	Disable	Drop
8	Disable	Disable	Disable	Disable	Drop
9	Disable	Disable	Disable	Disable	Drop
10	Disable	Disable	Disable	Disable	Drop
11	Disable	Disable	Disable	Disable	Drop
12	Disable	Disable	Disable	Disable	Drop
13	Disable	Disable	Disable	Disable	Drop
14	Disable	Disable	Disable	Disable	Drop
15	Disable	Disable	Disable	Disable	Drop
16	Disable	Disable	Disable	Disable	Drop
17	Disable	Disable	Disable	Disable	Drop
18	Disable	Disable	Disable	Disable	Drop
19	Disable	Disable	Disable	Disable	Drop
20	Disable	Disable	Disable	Disable	Drop
21	Disable	Disable	Disable	Disable	Drop
22	Disable	Disable	Disable	Disable	Drop
23	Disable	Disable	Disable	Disable	Drop
24	Disable	Disable	Disable	Disable	Drop
25	Disable	Disable	Disable	Disable	Drop
26	Disable	Disable	Disable	Disable	Drop

Each field is described in the following table.

Table 29 Monitor &gt; Port &gt; Storm Control

LABEL	DESCRIPTION
Storm Control	
Port	This field displays the port number.
State	This field displays the state.
Broadcast (pps)	Displays how many broadcast packets the port receives (in pps).
Unknown Multicast (pps)	Displays how many unknown multicast packets the port receives (in pps).
Unknown Unicast (pps)	Displays how many unknown unicast packets the port receives (in pps).
Action	Displays the action the device takes when a limit is reached. The following options are available: <ul style="list-style-type: none"><li>• <b>Drop</b> - drop the packet.</li><li>• <b>Shutdown</b> - shutdown the connection.</li></ul>

# CHAPTER 9

## Monitor: VLAN

### 9.1 Overview

This section provides information for **VLAN** in **Monitor**.

A VLAN (Virtual Local Area Network) allows a physical network to be partitioned into multiple logical networks. Devices on a logical network belong to one group. A device can belong to more than one group. With VLAN, a device cannot directly talk to or hear from devices that are not in the same group(s); the traffic must first go through a router.

In MTU (Multi-Tenant Unit) applications, VLAN is vital in providing isolation and security among the subscribers. When properly configured, VLAN prevents one subscriber from accessing the network resources of another on the same LAN, thus a user will not see the printers and hard disks of another user on the same network.

VLAN also increases network performance by limiting broadcasts to a smaller and more manageable logical broadcast domain. In traditional switched environments, all broadcast packets go to each and every individual port. With VLAN, all broadcasts are confined to a specific broadcast domain.

#### 9.1.1 What You Can Do in this Chapter

- The **VLAN** screen ([Section 9.2 on page 68](#)) displays VLAN, port, and VLAN port settings.
- The **Guest VLAN** screen ([Section 9.3 on page 71](#)) displays the global and port settings of the Switch.
- The **Voice VLAN** screen ([Section 9.4 on page 72](#)) displays the global and port settings of the Switch.

### 9.2 VLAN

Use this screen to view Switch VLAN settings.

#### 9.2.1 VLAN

Use this screen to view the Switch's VLAN settings. Click **Monitor > VLAN > VLAN > VLAN** to access this screen.

**Figure 61** Monitor > VLAN > VLAN > VLAN

VLAN		<a href="#">VLAN</a>	<a href="#">Port</a>	<a href="#">VLAN Port</a>
VLAN ID	VLAN Name	VLAN Type		
1	default	Default		

Each field is described in the following table.

Table 30 Monitor &gt; VLAN &gt; VLAN &gt; VLAN

LABEL	DESCRIPTION
VLAN	
VLAN ID	This is the VLAN identification number.
VLAN Name	Displays a descriptive name for the VLAN for identification purposes.
VLAN Type	Displays a type for the VLAN for identification purposes.

## 9.2.2 Port

Use this screen to view the Switch's port setting in VLAN. Click **Monitor > VLAN > VLAN > Port** to access this screen.

Figure 62 Monitor &gt; VLAN &gt; VLAN &gt; Port

Port		VLAN	Port	VLAN Port
Port	PVID	Accept Frame Type	Ingress Check	VLAN Trunk
1	1	ALL	Disable	Disable
2	1	ALL	Disable	Disable
3	1	ALL	Disable	Disable
4	1	ALL	Disable	Disable
5	1	ALL	Disable	Disable
6	1	ALL	Disable	Disable
7	1	ALL	Disable	Disable
8	1	ALL	Disable	Disable
9	1	ALL	Disable	Disable
10	1	ALL	Disable	Disable
11	1	ALL	Disable	Disable
12	1	ALL	Disable	Disable
13	1	ALL	Disable	Disable
14	1	ALL	Disable	Disable
15	1	ALL	Disable	Disable
16	1	ALL	Disable	Disable
17	1	ALL	Disable	Disable
18	1	ALL	Disable	Disable
19	1	ALL	Disable	Disable
20	1	ALL	Disable	Disable
21	1	ALL	Disable	Disable
22	1	ALL	Disable	Disable
23	1	ALL	Disable	Disable
24	1	ALL	Disable	Disable
25	1	ALL	Disable	Disable
26	1	ALL	Disable	Disable
LAG1	1	ALL	Disable	Disable
LAG2	1	ALL	Disable	Disable
LAG3	1	ALL	Disable	Disable
LAG4	1	ALL	Disable	Disable
LAG5	1	ALL	Disable	Disable
LAG6	1	ALL	Disable	Disable
LAG7	1	ALL	Disable	Disable
LAG8	1	ALL	Disable	Disable

Each field is described in the following table.

Table 31 Monitor &gt; VLAN &gt; VLAN &gt; Port

LABEL	DESCRIPTION
Port	
Port	This field displays the port number.
PVID	This is the port VLAN identification number.  A PVID (Port VLAN ID) is a tag that adds to incoming untagged frames received on a port so that the frames are forwarded to the VLAN group that the tag defines.

Table 31 Monitor &gt; VLAN &gt; VLAN &gt; Port (continued)

LABEL	DESCRIPTION
Accept Frame Type	This field displays the type that is accepted by the frame. Specifies the type of frames allowed on a port. Choices are <b>All</b> , <b>Tag Only</b> and <b>Untag Only</b> . <b>All</b> accepts all untagged or tagged frames on this port. This is the default setting. <b>Tag Only</b> accepts only tagged frames on this port. All untagged frames will be dropped. <b>Untag Only</b> accepts only untagged frames on this port. All tagged frames will be dropped.
Ingress Filter	If set, the Switch discards incoming frames for VLANs that do not have this port as a member.
VLAN Trunks	Enable <b>VLAN Trunking</b> on ports connected to other switches or routers (but not ports directly connected to end users) to allow frames belonging to unknown VLAN groups to pass through the Switch.

### 9.2.3 VLAN Port

Port-based VLANs are VLANs where the packet forwarding decision is based on the destination MAC address and its associated port. Port-based VLANs require allowed outgoing ports to be defined for each port. Therefore, if you wish to allow two subscriber ports to talk to each other, for example, between conference rooms in a hotel, you must define the egress (an egress port is an outgoing port, that is, a port through which a data packet leaves) for both ports. Port-based VLANs are specific only to the Switch on which they were created.

Use this screen to view the Switch's VLAN port settings. Click **Monitor > VLAN > VLAN > VLAN Port** to access this screen.

Figure 63 Monitor &gt; VLAN &gt; VLAN &gt; VLAN Port

Port	Membership
1	Untagged
2	Untagged
3	Untagged
4	Untagged
5	Untagged
6	Untagged
7	Untagged
8	Untagged
9	Untagged
10	Untagged
11	Untagged
12	Untagged
13	Untagged
14	Untagged
15	Untagged
16	Untagged
17	Untagged
18	Untagged
19	Untagged
20	Untagged
21	Untagged
22	Untagged
23	Untagged
LAG1	Untagged
LAG2	Untagged
LAG3	Untagged
LAG4	Untagged
LAG5	Untagged
LAG6	Untagged
LAG7	Untagged
LAG8	Untagged

Each field is described in the following table.

Table 32 Monitor > VLAN > VLAN > VLAN Port

LABEL	DESCRIPTION
VLAN Port	
VLAN ID	This is the VLAN identification number.
Port	Displays the port index value.
Membership	Displays the status of the VLAN group: <b>Forbidden</b> , <b>Excluded</b> , <b>Tagged</b> or <b>Untagged</b> .

## 9.3 Guest VLAN

When 802.1x port authentication is enabled on the Switch and its ports, clients that do not have the correct credentials are blocked from using the port(s). You can configure your Switch to have one VLAN that acts as a guest VLAN. If you enable the guest VLAN (**102** in the example) on a port (**2** in the example), the user (**A** in the example) that is not IEEE 802.1x capable or fails to enter the correct username and password can still access the port, but traffic from the user is forwarded to the guest VLAN. That is, unauthenticated users can have access to limited network resources in the same guest VLAN, such as the Internet. The rights granted to the Guest VLAN depends on how the network administrator configures switches or routers with the guest network feature.

Figure 64 Guest VLAN Example

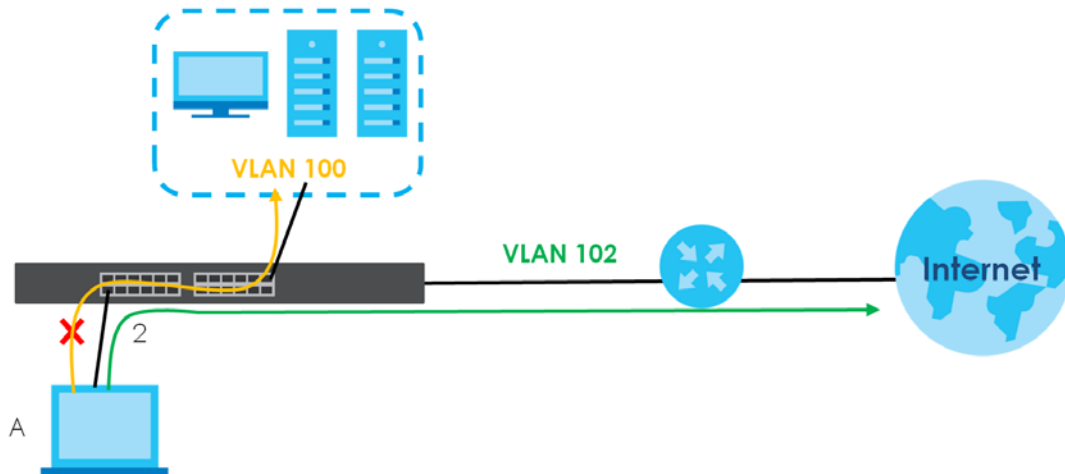

Use this screen to view the Switch's guest VLAN. Click **Monitor > VLAN > Guest VLAN** to access this screen.

Figure 65 Monitor &gt; VLAN &gt; Guest VLAN

Guest VLAN		
State		Disable
<b>Port</b>		
Port	State	In Guest VLAN
1	Disable	No
2	Disable	No
3	Disable	No
4	Disable	No
5	Disable	No
6	Disable	No
7	Disable	No
8	Disable	No
9	Disable	No
10	Disable	No
11	Disable	No
12	Disable	No
13	Disable	No
14	Disable	No
15	Disable	No
16	Disable	No
17	Disable	No
18	Disable	No
19	Disable	No
20	Disable	No
21	Disable	No
22	Disable	No
23	Disable	No
24	Disable	No
25	Disable	No
26	Disable	No

Each field is described in the following table.

Table 33 Monitor &gt; VLAN &gt; Guest VLAN

LABEL	DESCRIPTION
Guest VLAN	
State	This field displays the state of global guest VLAN.
Port	
Port	This field displays a port number.
State	This field displays the state of a port.
In Guest VLAN	This field displays the status of the port, is the port is in guest VLAN or not.

## 9.4 Voice VLAN

Voice VLANs are VLANs configured specially for voice traffic. By adding the ports connected with voice devices to voice VLANs, you can have voice traffic transmitted within voice VLANs and perform QoS-related configuration for voice traffic as required, thus ensuring the transmission priority of voice traffic and voice quality.

Use this screen to view Switch global and port voice VLAN settings for voice traffic. Click **Monitor > VLAN > Voice VLAN** to access this screen.



Figure 66 Monitor &gt; VLAN &gt; Voice VLAN

Voice VLAN	
State	Disable
Voice VLAN ID	none (disable)
Cos/802.1p	5
Remark Cos/802.1p	Disable
Aging Time (30-65536 min)	1440

Port	
Port	State
1	Disable
2	Disable
3	Disable
4	Disable
5	Disable
6	Disable
7	Disable
8	Disable
9	Disable
10	Disable
11	Disable
12	Disable
13	Disable
14	Disable
15	Disable
16	Disable
17	Disable
18	Disable
19	Disable
20	Disable
21	Disable
22	Disable
23	Disable
24	Disable
25	Disable
26	Disable

Each field is described in the following table.

Table 34 Monitor &gt; VLAN &gt; Voice VLAN

LABEL	DESCRIPTION
Voice VLAN	
State	This field displays the state of a port.
Voice VLAN ID	This is the voice VLAN identification number.
Cos/802.1p	This displays the packet's 802.1p priority field.
Remark Cos/802.1p	This field displays the state of the cos/802.1p.
Aging Time (30-65536 min)	Displays the time interval (from 30 to 65536) in minutes.
Port	
Port	This field displays a port number.
State	This field displays the state of a port.

# CHAPTER 10

## Monitor: MAC Table

### 10.1 Overview

This section provides information for **MAC Table** in **Monitor**.

The **MAC Table** screen (a MAC table is also known as a filtering database) shows how frames are forwarded or filtered across the Switch's ports. When a device (which may belong to a VLAN group) sends a packet which is forwarded to a port on the Switch, the MAC address of the device is shown on the Switch's **MAC Table**. It also shows whether the MAC address is dynamic (learned by the Switch) or static (manually entered in the **Static MAC Forwarding** screen).

The Switch uses the **MAC Table** to determine how to forward frames. See the following figure.

- 1 The Switch examines a received frame and learns the port from which this source MAC address came.
- 2 The Switch checks to see if the frame's destination MAC address matches a source MAC address already learned in the **MAC Table**.
  - If the Switch has already learned the port for this MAC address, then it forwards the frame to that port.
  - If the Switch has not already learned the port for this MAC address, then the frame is flooded to all ports. Too much port flooding leads to network congestion.
  - If the Switch has already learned the port for this MAC address, but the destination port is the same as the port it came in on, then it filters the frame.

Figure 67 MAC Table Flowchart

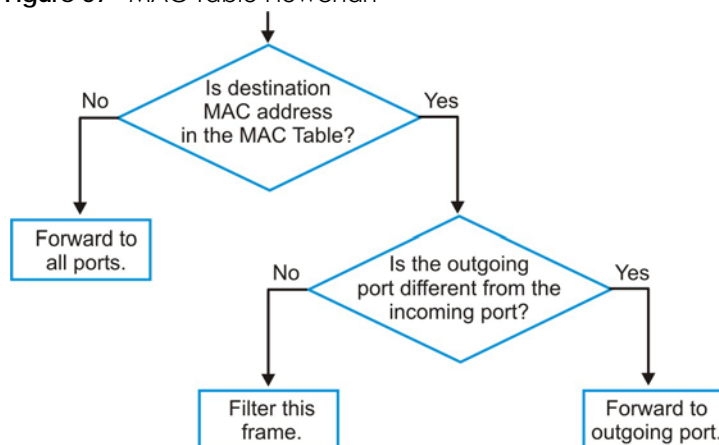

This link takes you to a screen where you can view the MAC address and VLAN ID of a device attach to a port. You can also view what kind of MAC address it is.

## 10.1.1 What You Can Do in this Chapter

- The **MAC Table** screen (Section 10.2 on page 75) displays view filter and MAC table of the Switch.

## 10.2 MAC Table

Use this screen to view filter static and MAC table settings. Click **Monitor > MAC Table** to access this screen.

**Figure 68** Monitor > MAC Table

MAC Table			
MAC Address	---	(00:00:00:00:00:00)	
VLAN	---	▼	
Port	---	▼	
<input type="button" value="View"/> <input type="button" value="Clear"/>			
MAC Address	VLAN	Type	Port
10:BF:48:D5:AB:72	default(1)	Dynamic	24
20:6A:8A:00:F2:57	default(1)	Dynamic	24
20:6A:8A:39:FB:38	default(1)	Dynamic	24
3C:97:0E:63:AF:24	default(1)	Dynamic	24
4C:9E:FF:72:4A:87	default(1)	Static Unicast	CPU
74:27:EA:2B:FA:AA	default(1)	Dynamic	24
90:2B:34:BB:7A:A4	default(1)	Dynamic	24
B8:EC:A3:0F:CF:9F	default(1)	Dynamic	24
C0:3F:D5:F9:9A:48	default(1)	Dynamic	24
C0:3F:D5:F9:BA:0A	default(1)	Dynamic	24
DC:4A:3E:40:EC:5F	default(1)	Dynamic	24
DC:4A:3E:40:EC:67	default(1)	Dynamic	12
E4:18:6B:F7:BA:79	default(1)	Dynamic	24
E4:18:6B:F7:BA:8B	default(1)	Dynamic	24
Total Entries: 14			

Each field is described in the following table.

**Table 35** Monitor > MAC Table

LABEL	DESCRIPTION
MAC Table	
MAC Address	This is the MAC address of the device from which this incoming frame came.
VLAN	Displays a type for the VLAN for identification purposes.
Port	This is the port from which the above MAC address was learned.
View	This link takes you to a screen where you can view the MAC address and VLAN ID of a device attach to a port. You can also view what kind of MAC address it is.
Clear	Click <b>Clear</b> to return the fields to the factory defaults.
MAC Address	This is the MAC address of the device from which this incoming frame came.
VLAN	Displays a type for the VLAN for identification purposes.

Table 35 Monitor &gt; MAC Table (continued)

LABEL	DESCRIPTION
Type	This shows whether the MAC address is <b>dynamic</b> (learned by the Switch) or <b>static</b> (manually entered in the <b>Static MAC Forwarding</b> screen).
Port	This is the port from which the above MAC address was learned.
Total Entries	Displays the number of total entries.

# CHAPTER 11

## Monitor: Link Aggregation

### 11.1 Overview

This section provides information for **Link Aggregation in Monitor**.

Link aggregation (trunking) is the grouping of physical ports into one logical higher-capacity link. You may want to trunk ports if for example, it is cheaper to use multiple lower-speed links than to under-utilize a high-speed, but more costly, single-port link. However, the more ports you aggregate then the fewer available ports you have. A trunk group is one logical link containing multiple ports.

The Switch supports both static and dynamic link aggregation.

Note: In a properly planned network, it is recommended to implement static link aggregation only. This ensures increased network stability and control over the trunk groups on your Switch.

#### 11.1.1 What You Can Do in this Chapter

- The **Link Aggregation** screen ([Section 11.2 on page 77](#)) displays link aggregation status.

### 11.2 Link Aggregation

Use the **Link Aggregation** screens to view Switch link aggregation status. Click **Monitor > Link Aggregation** to access this screen.

**Figure 69** Monitor > Link Aggregation

Link Aggregation					
LAG	Name	Type	Link Status	Active Member	Standby Member
LAG1		---	Not Present	---	---
LAG2		---	Not Present	---	---
LAG3		---	Not Present	---	---
LAG4		---	Not Present	---	---
LAG5		---	Not Present	---	---
LAG6		---	Not Present	---	---
LAG7		---	Not Present	---	---
LAG8		---	Not Present	---	---

Each field is described in the following table.

Table 36 Monitor > Link Aggregation

LABEL	DESCRIPTION
LAG	Displays the link aggregation status index value.
Name	This field displays the name.
Type	This field displays the type.
Link Status	This field displays the status of the link. It displays <b>Up</b> when the port is linked up or <b>Down</b> when it is not. When no any physical port is binding with this group, it displays <b>NotPresent</b> .
Active Member	Displays if this member is an active member of a trunk.
Standby Member	Displays if this member is an standby member of a trunk.

# CHAPTER 12

## Monitor: Loop Guard

### 12.1 Overview

This section provides information for **Loop Guard** in **Monitor**.

Loop guard is designed to handle loop problems on the edge of your network. This can occur when a port is connected to a Switch that is in a loop state. Loop state occurs as a result of human error. It happens when two ports on a switch are connected with the same cable. When a switch in loop state sends out broadcast messages the messages loop back to the switch and are re-broadcast again and again causing a broadcast storm.

If a switch (not in loop state) connects to a switch in loop state, then it will be affected by the switch in loop state in the following way:

- It will receive broadcast messages sent out from the switch in loop state.
- It will receive its own broadcast messages that it sends out as they loop back. It will then re-broadcast those messages again.

The following figure shows port **N** on switch **A** connected to switch **B**. Switch **B** is in loop state. When broadcast or multicast packets leave port **N** and reach switch **B**, they are sent back to port **N** on **A** as they are rebroadcast from **B**.

**Figure 70** Switch in Loop State

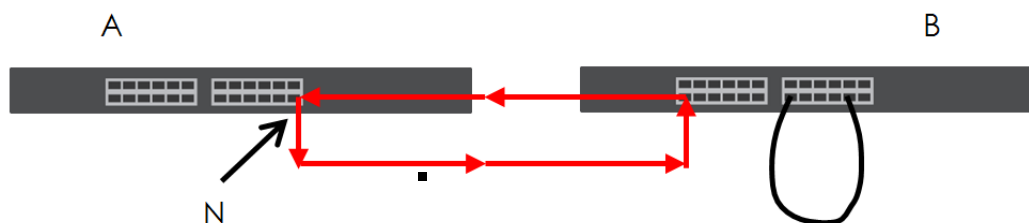

The loop guard feature checks to see if a loop guard enabled port is connected to a switch in loop state. This is accomplished by periodically sending a probe packet and seeing if the packet returns on the same port. If this is the case, the Switch will shut down the port connected to the switch in loop state.

The following figure shows a loop guard enabled port **N** on switch **A** sending a probe packet **P** to switch **B**. Since switch **B** is in loop state, the probe packet **P** returns to port **N** on **A**. The Switch then shuts down port **N** to ensure that the rest of the network is not affected by the switch in loop state.

Figure 71 Loop Guard - Probe Packet

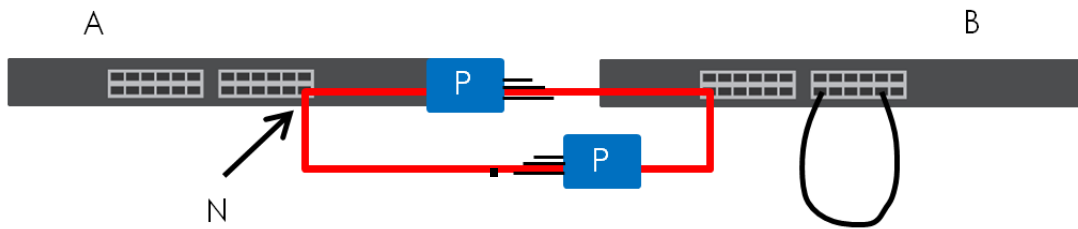

The Switch also shuts down port **N** if the probe packet returns to switch **A** on any other port. In other words loop guard also protects against standard network loops. The following figure illustrates three switches forming a loop. A sample path of the loop guard probe packet is also shown. In this example, the probe packet is sent from port **N** and returns on another port. As long as loop guard is enabled on port **N**. The Switch will shut down port **N** if it detects that the probe packet has returned to the Switch.

Figure 72 Loop Guard - Network Loop

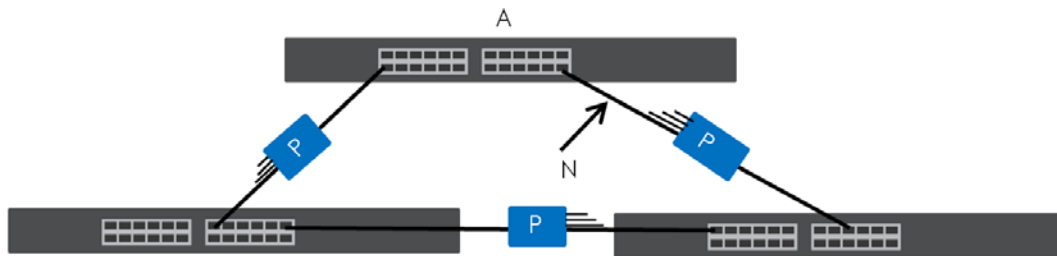

### 12.1.1 What You Can Do in this Chapter

- The **Loop Guard** screen ([Section 12.2 on page 80](#)) displays loop guard status.

## 12.2 Loop Guard

Use the **Loop Guard** screen to view Switch loop guard status. Click **Monitor > Loop Guard** to access this screen.



Figure 73 Monitor &gt; Loop Guard

Loop Guard			
Port	Status	Time Left (sec)	Action
1	No Loop	---	Recovery
2	No Loop	---	Recovery
3	No Loop	---	Recovery
4	No Loop	---	Recovery
5	No Loop	---	Recovery
6	No Loop	---	Recovery
7	No Loop	---	Recovery
8	No Loop	---	Recovery
9	No Loop	---	Recovery
10	No Loop	---	Recovery
11	No Loop	---	Recovery
12	No Loop	---	Recovery
13	No Loop	---	Recovery
14	No Loop	---	Recovery
15	No Loop	---	Recovery
16	No Loop	---	Recovery
17	No Loop	---	Recovery
18	No Loop	---	Recovery
19	No Loop	---	Recovery
20	No Loop	---	Recovery
21	No Loop	---	Recovery
22	No Loop	---	Recovery
23	No Loop	---	Recovery
24	No Loop	---	Recovery
25	No Loop	---	Recovery
26	No Loop	---	Recovery

Each field is described in the following table.

Table 37 Monitor &gt; Loop Guard

LABEL	DESCRIPTION
Loop Guard	
Port	This field displays a port number.
Status	This field displays the status.
Time Left (sec)	This field displays the amount of time left in seconds.
Action	This field displays the action.

# CHAPTER 13

## Monitor: Multicast

### 13.1 Overview

This section provides information for **Multicast** in **Monitor**.

Traditionally, IP packets are transmitted in one of either two ways - Unicast (1 sender to 1 recipient) or Broadcast (1 sender to everybody on the network). Multicast delivers IP packets to just a group of hosts on the network.

IGMP (Internet Group Management Protocol) is a network-layer protocol used to establish membership in an IPv4 multicast group - it is not used to carry user data. Refer to RFC 1112, RFC 2236 and RFC 3376 for information on IGMP versions 1, 2 and 3 respectively.

#### 13.1.1 What You Can Do in this Chapter

- The **IGMP** screen ([Section 13.2 on page 82](#)) displays Vlan, statistics, group, and router.

### 13.2 IGMP

Use this screen to view Switch various multicast features.

#### 13.2.1 VLAN

Use this screen to view the Switch's IGMP vlan. Click **Monitor > Multicast > IGMP > VLAN** to access this screen.

**Figure 74** Monitor > Multicast > IGMP > VLAN

VLAN ID	Operate Status	Router Ports	Query	Last Member Query	Querier					
ID	Status	Auto Learn	Retry	Interval	Max. Response Interval	Count	Interval	Status	Version	IP
1	Disable	Enable	2	125	10	2	1	Non-Querier	---	---

Total Entries: 1

Each field is described in the following table.

**Table 38** Monitor > Multicast > IGMP > VLAN

LABEL	DESCRIPTION
IGMP Vlan	
VLAN ID	Displays the identification for the VLAN.
Operate Status	Displays the status of the operation.

Table 38 Monitor > Multicast > IGMP > VLAN (continued)

LABEL	DESCRIPTION
Router Ports Auto Learn	Displays whether the router ports are auto learn or not.
Query	
Retry	Displays the number of retry.
Interval	Displays the number (in seconds) for the time interval.
Max. Response Interval(sec)	Displays the maximum response (in seconds) for the time interval.
Last Member Query	
Count	Displays the number of count.
Interval(sec)	Displays the in seconds for the time interval.
Querier	Allows the Switch to send IGMP General Query messages to the VLANs with the multicast hosts attached.
Status	This field displays the entry as querier or non-querier.
Version	This field displays the entry querier version.
IP	This field displays the entry querier IP address.
Total Entries	This field displays the number of total entries.

### 13.2.2 Statistics

Use this screen to view the Switch's IGMP statistics. Click **Monitor > Multicast > IGMP > Statistics** to access this screen.

Figure 75 Monitor > Multicast > IGMP > Statistics



Each field is described in the following table.

Table 39 Monitor > Multicast > IGMP > Statistics

LABEL	DESCRIPTION
IGMP Statistics	
Port	This field displays a port number.
Total RX	This field displays the total amount of RX.

Table 39 Monitor &gt; Multicast &gt; IGMP &gt; Statistics

LABEL	DESCRIPTION
Valid RX	This field displays the total amount of valid RX.
Invalid RX	This field displays the total amount of invalid RX.
Other RX	This field displays the total amount of other RX.
Leave RX	This field displays the total amount of leave RX.
Report RX	This field displays the total amount of report RX.
General Query RX	This field displays the total amount of general query RX.
Group-Spec Query RX	This field displays the total amount of group-spec query RX.
Source-Spec Query RX	This field displays the total amount of source-spec query RX.
Leave TX	This field displays the total amount of leave TX.
Report TX	This field displays the total amount of report TX.
General Query TX	This field displays the total amount of general query TX.
Group-Spec Query TX	This field displays the total amount of group-spec query TX.
Source-Spec Query TX	This field displays the total amount of source-spec query TX.
Action	Click <b>Action</b> to reset the statistics of the specific field back to zero.
Clear	Click <b>Clear</b> to clear statistics on this port.
Clear	Click <b>Clear</b> to reset the fields to the factory defaults.
Refresh	Click <b>Refresh</b> to reload the page.

In the Action column, the **Action** option allows you to clear the statistics.

Click **OK** and confirm at the pop-up screen to complete the task. Click **Cancel** and confirm at the pop-up screen to discard the changes.

Figure 76 Monitor &gt; Multicast &gt; IGMP &gt; Statistics &gt; Action

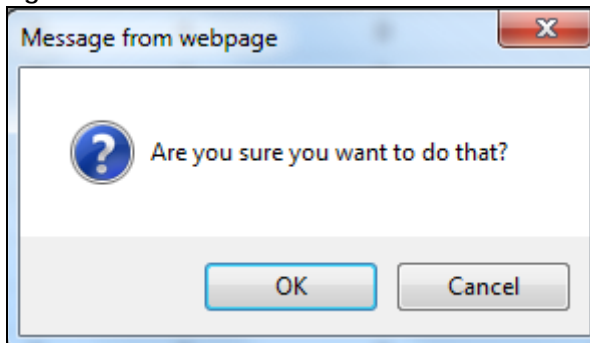

### 13.2.3 Group

Use this screen to view the Switch's IGMP group. Click **Monitor > Multicast > IGMP > Group** to access this screen.

Figure 77 Monitor &gt; Multicast &gt; IGMP &gt; Group

IGMP Group				VLAN	Statistics	Group	Router
VLAN ID	Group IP Address	Member Ports	Life(sec)				
							Total Entries: 0
				Clear	Refresh		

Each field is described in the following table.

Table 40 Monitor &gt; Multicast &gt; IGMP &gt; Group

LABEL	DESCRIPTION
IGMP Group	
VLAN ID	Displays the identification for the VLAN.
Group IP Address	This field displays the group IP address.
Member Ports	This field displays the member ports.
Life(sec)	Displays life in seconds for the time interval.
Total Entries	This field displays the number of total entries.
Clear	Click <b>Clear</b> to delete the dynamic groups.
Refresh	Click <b>Refresh</b> to reload the page.

## 13.2.4 Router

Use this screen to view the Switch's IGMP router. Click **Monitor > Multicast > IGMP > Router** to access this screen.

Figure 78 Monitor &gt; Multicast &gt; IGMP &gt; Router

IGMP Router			
VLAN ID	Dynamic Router Ports	Static Router Ports	Forbidden Router Ports
Total Entries: 0			

Each field is described in the following table.

Table 41 Monitor &gt; Multicast &gt; IGMP &gt; Router

LABEL	DESCRIPTION
IGMP Router	
VLAN ID	Displays the identification for the VLAN.
Dynamic Router Ports	This field displays the dynamic router ports.
Static Router Ports	This field displays the static router ports.
Forbidden Router Ports	This field displays the forbidden router ports.
Total Entries	This field displays the number of total entries.

# CHAPTER 14

## Monitor: Spanning Tree

### 14.1 Overview

This section provides information for **Spanning Tree** in **Monitor**.

The Switch supports Spanning Tree Protocol (STP), Common and Internal Spanning Tree (CIST), and Multiple Spanning Tree (MST).

#### 14.1.1 What You Can Do in this Chapter

- The **Spanning Tree** screen ([Section 14.2 on page 86](#)) displays CIST, CIST port, MST, MST port, STP statistics.

### 14.2 Spanning Tree

Use this screen to view Switch spanning tree settings.

#### 14.2.1 CIST

Use this screen to view the Switch's spanning tree CIST instance. Click **Monitor > Spanning Tree > CIST** to access this screen.

**Figure 79** Monitor > Spanning Tree > CIST

CIST Instance		<a href="#">CIST</a>	<a href="#">CIST Port</a>	<a href="#">MST</a>	<a href="#">MST Port</a>	<a href="#">STP Statistics</a>
State	Disable					
Bridge Identifier	32768/ 0/4C:9E:FF:72:4A:87					
Designated Root Bridge	0/ 0/00:00:00:00:00:00					
External Root Path Cost	0					
Regional Root Bridge	0/ 0/00:00:00:00:00:00					
Internal Root Path Cost	0					
Designated Bridge	0/ 0/00:00:00:00:00:00					
Root Port	0/0					
Remaining Hops	0					
Last Topology Change	0					

Each field is described in the following table.

**Table 42** Monitor > Spanning Tree > CIST

LABEL	DESCRIPTION
CIST Instance	
State	This field displays the state.

Table 42 Monitor > Spanning Tree > CIST

LABEL	DESCRIPTION
Bridge Identifier	This is the unique identifier for this bridge, consisting of the bridge priority plus the MAC address.
Designated Root Bridge	Root bridge refers to the base of the spanning tree.
External Root Path Cost	The cost of the path from this bridge to the cist Root Bridge.
Regional Root Bridge	Root bridge refers to the base of the spanning tree.
Internal Root Path Cost	The cost of the path from this bridge to the internal Regional Root Bridge.
Designated Bridge	For each LAN segment, a designated bridge is selected. This bridge has the lowest cost to the root among the bridges connected to the LAN.
Root Port	On each bridge, the bridge communicates with the root through the root port. The root port is the port on this Switch with the lowest path cost to the root (the root path cost). If there is no root port, then this Switch has been accepted as the root bridge of the spanning tree network.
Remaning Hops	This field displays the number of remaning hops.
Last Topology Change	Topology change information is directly propagatged throughout the network from the device that generates the topology change.

## 14.2.2 CIST Port

Use this screen to view the Switch's spanning tree CIST port status. Click **Monitor > Spanning Tree > CIST Port** to access this screen.

Figure 80 Monitor > Spanning Tree > CIST Port

Port	Identifier (Priority / Port Id)	External Path Cost	Internal Path Cost	Designated Root Bridge	External Root Cost	Regional Root Bridge	Internal Root Cost	Designated Bridge	Edge Port Operation	P2P MAC Operation	Port Role	Port State
1	128 / 1	20000	20000	0 / 00:00:00:00:00:00	0	0 / 00:00:00:00:00:00	0	0 / 00:00:00:00:00:00	Yes	No	Disable	Disable
2	128 / 2	20000	20000	0 / 00:00:00:00:00:00	0	0 / 00:00:00:00:00:00	0	0 / 00:00:00:00:00:00	Yes	No	Disable	Disable
3	128 / 3	20000	20000	0 / 00:00:00:00:00:00	0	0 / 00:00:00:00:00:00	0	0 / 00:00:00:00:00:00	Yes	No	Disable	Disable
4	128 / 4	20000	20000	0 / 00:00:00:00:00:00	0	0 / 00:00:00:00:00:00	0	0 / 00:00:00:00:00:00	Yes	No	Disable	Disable
5	128 / 5	20000	20000	0 / 00:00:00:00:00:00	0	0 / 00:00:00:00:00:00	0	0 / 00:00:00:00:00:00	Yes	No	Disable	Disable
6	128 / 6	20000	20000	0 / 00:00:00:00:00:00	0	0 / 00:00:00:00:00:00	0	0 / 00:00:00:00:00:00	Yes	No	Disable	Disable
7	128 / 7	20000	20000	0 / 00:00:00:00:00:00	0	0 / 00:00:00:00:00:00	0	0 / 00:00:00:00:00:00	Yes	No	Disable	Disable
8	128 / 8	20000	20000	0 / 00:00:00:00:00:00	0	0 / 00:00:00:00:00:00	0	0 / 00:00:00:00:00:00	Yes	No	Disable	Disable
9	128 / 9	20000	20000	0 / 00:00:00:00:00:00	0	0 / 00:00:00:00:00:00	0	0 / 00:00:00:00:00:00	Yes	No	Disable	Disable
10	128 / 10	20000	20000	0 / 00:00:00:00:00:00	0	0 / 00:00:00:00:00:00	0	0 / 00:00:00:00:00:00	Yes	No	Disable	Disable
11	128 / 11	20000	20000	0 / 00:00:00:00:00:00	0	0 / 00:00:00:00:00:00	0	0 / 00:00:00:00:00:00	Yes	No	Disable	Disable
12	128 / 12	20000	20000	0 / 00:00:00:00:00:00	0	0 / 00:00:00:00:00:00	0	0 / 00:00:00:00:00:00	Yes	No	Disable	Disable
13	128 / 13	20000	20000	0 / 00:00:00:00:00:00	0	0 / 00:00:00:00:00:00	0	0 / 00:00:00:00:00:00	Yes	No	Disable	Disable
14	128 / 14	20000	20000	0 / 00:00:00:00:00:00	0	0 / 00:00:00:00:00:00	0	0 / 00:00:00:00:00:00	Yes	No	Disable	Disable
15	128 / 15	20000	20000	0 / 00:00:00:00:00:00	0	0 / 00:00:00:00:00:00	0	0 / 00:00:00:00:00:00	Yes	No	Disable	Disable
16	128 / 16	20000	20000	0 / 00:00:00:00:00:00	0	0 / 00:00:00:00:00:00	0	0 / 00:00:00:00:00:00	Yes	No	Disable	Disable
17	128 / 17	20000	20000	0 / 00:00:00:00:00:00	0	0 / 00:00:00:00:00:00	0	0 / 00:00:00:00:00:00	Yes	No	Disable	Disable
18	128 / 18	20000	20000	0 / 00:00:00:00:00:00	0	0 / 00:00:00:00:00:00	0	0 / 00:00:00:00:00:00	Yes	No	Disable	Disable
19	128 / 19	20000	20000	0 / 00:00:00:00:00:00	0	0 / 00:00:00:00:00:00	0	0 / 00:00:00:00:00:00	Yes	No	Disable	Disable
20	128 / 20	20000	20000	0 / 00:00:00:00:00:00	0	0 / 00:00:00:00:00:00	0	0 / 00:00:00:00:00:00	Yes	No	Disable	Disable
21	128 / 21	20000	20000	0 / 00:00:00:00:00:00	0	0 / 00:00:00:00:00:00	0	0 / 00:00:00:00:00:00	Yes	No	Disable	Disable
22	128 / 22	20000	20000	0 / 00:00:00:00:00:00	0	0 / 00:00:00:00:00:00	0	0 / 00:00:00:00:00:00	Yes	No	Disable	Disable
23	128 / 23	20000	20000	0 / 00:00:00:00:00:00	0	0 / 00:00:00:00:00:00	0	0 / 00:00:00:00:00:00	Yes	No	Disable	Disable
24	128 / 24	20000	20000	0 / 00:00:00:00:00:00	0	0 / 00:00:00:00:00:00	0	0 / 00:00:00:00:00:00	Yes	No	Disable	Disable
25	128 / 25	20000	20000	0 / 00:00:00:00:00:00	0	0 / 00:00:00:00:00:00	0	0 / 00:00:00:00:00:00	Yes	No	Forwarding	Forwarding
26	128 / 26	20000	20000	0 / 00:00:00:00:00:00	0	0 / 00:00:00:00:00:00	0	0 / 00:00:00:00:00:00	Yes	No	Disable	Disable
LAG1	128 / 27	20000	20000	0 / 00:00:00:00:00:00	0	0 / 00:00:00:00:00:00	0	0 / 00:00:00:00:00:00	Yes	No	Disable	Disable
LAG2	128 / 28	20000	20000	0 / 00:00:00:00:00:00	0	0 / 00:00:00:00:00:00	0	0 / 00:00:00:00:00:00	Yes	No	Disable	Disable
LAG3	128 / 29	20000	20000	0 / 00:00:00:00:00:00	0	0 / 00:00:00:00:00:00	0	0 / 00:00:00:00:00:00	Yes	No	Disable	Disable
LAG4	128 / 30	20000	20000	0 / 00:00:00:00:00:00	0	0 / 00:00:00:00:00:00	0	0 / 00:00:00:00:00:00	Yes	No	Disable	Disable
LAG5	128 / 31	20000	20000	0 / 00:00:00:00:00:00	0	0 / 00:00:00:00:00:00	0	0 / 00:00:00:00:00:00	Yes	No	Disable	Disable
LAG6	128 / 32	20000	20000	0 / 00:00:00:00:00:00	0	0 / 00:00:00:00:00:00	0	0 / 00:00:00:00:00:00	Yes	No	Disable	Disable
LAG7	128 / 33	20000	20000	0 / 00:00:00:00:00:00	0	0 / 00:00:00:00:00:00	0	0 / 00:00:00:00:00:00	Yes	No	Disable	Disable
LAG8	128 / 34	20000	20000	0 / 00:00:00:00:00:00	0	0 / 00:00:00:00:00:00	0	0 / 00:00:00:00:00:00	Yes	No	Disable	Disable

Each field is described in the following table.

Table 43 Monitor > Spanning Tree > CIST Port

LABEL	DESCRIPTION
Port	This field displays the port number.
Identifier (Priority / Port Id)	This field displays the identifier (in priority / port number).
External Path Cost Operation	Path cost is the cost of transmitting a frame on to a LAN through that port. It is recommended to assign this value according to the speed of the bridge. The slower the media, the higher the cost.

Table 43 Monitor &gt; Spanning Tree &gt; CIST Port

LABEL	DESCRIPTION
Internal Path Cost Operation	Path cost is the cost of transmitting a frame on to a LAN through that port. It is recommended to assign this value according to the speed of the bridge. The slower the media, the higher the cost.
Designated Root Bridge	Root bridge refers to the base of the spanning tree.
External Root Cost	This field displays the external root cost.
Regional Root Bridge	Root bridge refers to the base of the spanning tree.
Internal Root Cost	This field displays the internal root cost.
Designated Bridge	For each LAN segment, a designated bridge is selected. This bridge has the lowest cost to the root among the bridges connected to the LAN.
Edge Port Operation	An edge port changes its initial STP port state from blocking state to forwarding state immediately without going through listening and learning states right after the port is configured as an edge port or when its link status changes.
P2P MAC Operation	This field displays the state of the P2P MAC operation.
Port Role	This field displays the state of the port role.
Port State	This field displays the state of the port.

### 14.2.3 MST

Use this screen to view the Switch's spanning tree MST instance. Click **Monitor > Spanning Tree > MST** to access this screen.

Figure 81 Monitor &gt; Spanning Tree &gt; MST

MST Instance		<a href="#">CIST</a>	<a href="#">CIST Port</a>	<a href="#">MST</a>	<a href="#">MST Port</a>	<a href="#">STP Statistics</a>
MST ID	1					
State	Disable					
Regional Root Bridge	---/--					
Internal Root Cost	---					
Designated Bridge	--/--					
Root Port	---/--					
Remaining Hops	---/--					
Last Topology Change	---/--					

Each field is described in the following table.

Table 44 Monitor &gt; Spanning Tree &gt; MST

LABEL	DESCRIPTION
MST Instance	
MST ID	This is the unique identifier for this MST. Select a number from the drop-down menu to display results.
State	This field displays the state.
Regional Root Bridge	Root bridge refers to the base of the spanning tree.
Internal Root Cost	This field displays the internal root cost.
Designated Bridge	For each LAN segment, a designated bridge is selected. This bridge has the lowest cost to the root among the bridges connected to the LAN.



Table 44 Monitor > Spanning Tree > MST

LABEL	DESCRIPTION
Root Port	On each bridge, the bridge communicates with the root through the root port. The root port is the port on this Switch with the lowest path cost to the root (the root path cost). If there is no root port, then this Switch has been accepted as the root bridge of the spanning tree network.
Remaining Hops	This field displays the number of remaining hops.
Last Topology Change	Topology change information is directly propagated throughout the network from the device that generates the topology change.

## 14.2.4 MST Port

Use this screen to view the Switch's spanning tree MST port status. Click **Monitor > Spanning Tree > MST Port** to access this screen.

Figure 82 Monitor > Spanning Tree > MST Port

Port	MST ID	Identifier (Priority / Port Id)	Internal Path Cost(Operation)	Regional Root Bridge	Internal Root Cost	Designated Bridge	Port Role	Port State
1	1	128/1	---	---	---	---	---	---
2	1	128/2	---	---	---	---	---	---
3	1	128/3	---	---	---	---	---	---
4	1	128/4	---	---	---	---	---	---
5	1	128/5	---	---	---	---	---	---
6	1	128/6	---	---	---	---	---	---
7	1	128/7	---	---	---	---	---	---
8	1	128/8	---	---	---	---	---	---

Each field is described in the following table.

Table 45 Monitor > Spanning Tree > MST Port

LABEL	DESCRIPTION
MST Port	
MST ID	This is the unique identifier for this MST. Select a number from the drop-down menu to display results.
Port	This field displays the port number.
MSTI ID	A VLAN can be mapped to a specific Multiple Spanning Tree Instance (MSTI). MSTI allows multiple VLANs to use the same spanning tree.
Identifier (Priority / Port Id)	This field displays the identifier (in priority / port number).
Internal Path Cost(Operation)	Path cost is the cost of transmitting a frame on to a LAN through that port. It is recommended to assign this value according to the speed of the bridge. The slower the media, the higher the cost.
Regional Root Bridge	Root bridge refers to the base of the spanning tree.
Internal Root Cost	This field displays the internal root cost.

Table 45 Monitor &gt; Spanning Tree &gt; MST Port (continued)

LABEL	DESCRIPTION
Designated Bridge	For each LAN segment, a designated bridge is selected. This bridge has the lowest cost to the root among the bridges connected to the LAN.
Port Role	This field displays the state of the port role.
Port State	This field displays the state of the port.

## 14.2.5 STP Statistics

(R)STP detects and breaks network loops and provides backup links between switches, bridges or routers. It allows a Switch to interact with other (R)STP-compliant switches in your network to ensure that only one path exists between any two stations on the network.

The Switch uses IEEE 802.1w RSTP (Rapid Spanning Tree Protocol) that allows faster convergence of the spanning tree than STP (while also being backwards compatible with STP-only aware bridges). In RSTP, topology change information is directly propagated throughout the network from the device that generates the topology change. In STP, a longer delay is required as the device that causes a topology change first notifies the root bridge and then the root bridge notifies the network. Both RSTP and STP flush unwanted learned addresses from the filtering database. In RSTP, the port states are Discarding, Learning, and Forwarding.

Note: In this user's guide, "STP" refers to both STP and RSTP.

Use this screen to view the Switch's spanning tree STP statistics. Click **Monitor > Spanning Tree > STP Statistics** to access this screen.

Figure 83 Monitor &gt; Spanning Tree &gt; STP Statistics

Port	MST Port			CIST CIST Port MST MST Port STP Statistics		
	Configuration BDPUs Received	TCN BDPUs Received	MSTP BDPUs Received	Configuration BDPUs Transmitted	TCN BDPUs Transmitted	MSTP BDPUs Transmitted
1	0	0	0	0	0	0
2	0	0	0	0	0	0
3	0	0	0	0	0	0
4	0	0	0	0	0	0
5	0	0	0	0	0	0
6	0	0	0	0	0	0
7	0	0	0	0	0	0
23	0	0	0	0	0	0
24	0	0	0	0	0	0
25	0	0	0	0	0	0
26	0	0	0	0	0	0
LAG1	0	0	0	0	0	0
LAG2	0	0	0	0	0	0
LAG3	0	0	0	0	0	0
LAG4	0	0	0	0	0	0
LAG5	0	0	0	0	0	0
LAG6	0	0	0	0	0	0
LAG7	0	0	0	0	0	0
LAG8	0	0	0	0	0	0

Each field is described in the following table.

Table 46 Monitor &gt; Spanning Tree &gt; STP Statistics

LABEL	DESCRIPTION
MST Port	
Port	This field displays the port number.
Configuration BDPUs Received	This field displays the configuration BDPUs received.
TCN BDPUs Received	This field displays the TCN BDPUs received.
MSTP BDPUs Received	This field displays the Multiple Spanning Tree Protocol (MSTP) BDPUs received.
Configuration BDPUs Transmitted	This field displays the configuration BDPUs transmitted.
TCN BDPUs Transmitted	This field displays the TCN BDPUs transmitted.
MSTP BDPUs Transmitted	This field displays the Multiple Spanning Tree Protocol (MSTP) BDPUs transmitted.

# CHAPTER 15

## Monitor: LLDP

### 15.1 Overview

This section provides information for **LLDP** in **Monitor**.

Link Layer Discovery Protocol (LLDP), defined as IEEE 802.1ab, enables LAN devices that support LLDP to exchange their configured settings. This helps eliminate configuration mismatch issues.

#### 15.1.1 What You Can Do in this Chapter

- The **LLDP** screen ([Section 15.2 on page 92](#)) displays statistics, remote information, and overloading.

### 15.2 LLDP

This link takes you to a screen where you can view LLDP on the Switch. LLDP allows a network device to advertise its identity and capabilities on the local network. It also allows the device to maintain and store information from adjacent devices which are directly connected to the network device.

#### 15.2.1 Statistics

Use this screen to view the Switch's LLDP global and port statistics. Click **Monitor > LLDP > Statistics** to access this screen.

Figure 84 Monitor &gt; LLDP &gt; Statistics

Statistics		<a href="#">Statistics</a>	<a href="#">Remote Information</a>	<a href="#">Overloading</a>			
Insertions	1						
Deletions	0						
Drops	0						
Age Outs	0						
<input type="button" value="Clear"/> <input type="button" value="Refresh"/>							
LLDP Port Statistics							
Port	TX Frames		RX Frames		RX TLVs		RX Ageouts
	Total	Total	Discarded	Errors	Discarded	Unrecognized	Total
1	0	0	0	0	0	0	0
2	0	0	0	0	0	0	0
3	0	0	0	0	0	0	0
4	0	0	0	0	0	0	0
5	0	0	0	0	0	0	0
6	0	0	0	0	0	0	0
22	0	0	0	0	0	0	0
23	0	0	0	0	0	0	0
24	465	465	0	0	0	0	0
25	0	0	0	0	0	0	0
26	0	0	0	0	0	0	0

Each field is described in the following table.



Table 47 Monitor &gt; LLDP &gt; Statistics

LABEL	DESCRIPTION
Statistics	
Insertions	This field displays the number of insertions.
Deletions	This field displays the number of deletions.
Drops	This field displays the number of drops.
Age Outs	This field displays the number of age outs.
Clear	Click <b>Clear</b> to clear statistics.
Refresh	Click <b>Refresh</b> to reload the page.
LLDP Port Statistics	
Port	This field displays the port number.
TX Frames Total	This field displays the total number of TX LLDP frames.
RX Frames Total	This field displays the total number of RX LLDP frames.
RX Frames Discarded	This field displays the number of discarded RX LLDP frames.
RX Frames Errors	This field displays the number of RX LLDP frames errors.
RX TLVs Discarded	This field displays the number of discarded RX LLDP TLVs.
RX TLVs Unrecognized	This field displays the number of unrecognized RX LLDP TLVs.
RX Ageouts Total	This field displays the total number of RX LLDP ageouts.

## 15.2.2 Remote Information

Use this screen to view the Switch's LLDP remote device information. Click **Monitor > LLDP > Remote Information** to access this screen.

Figure 85 Monitor > LLDP > Remote Information

Remote Device				Statistics			Remote Information	Overloading
Local Port	Chassis ID Subtype	Chassis ID	Port ID Subtype	Port ID	System Name	Time to Live	Action	
24	MAC address	E4:18:6B:F7:B A:79	Locally assigned	18	11A01_64	95	 	

Each field is described in the following table.

Table 48 Monitor > LLDP > Remote Information

LABEL	DESCRIPTION
Remote Device	
Local Port	This field displays the local port.
Chassis ID Subtype	This field displays the chassis ID subtype.
Chassis ID	This field displays the chassis ID.
Port ID Subtype	This field displays the port ID subtype.
Port ID	This field displays the port ID.
System Name	This field displays the descriptive name of the Switch for identification purposes.
Time to Live	This field displays the live time of this entry.
Action	
Detail	Click <b>Detail</b> to show more information about this entry.
Delete	Click <b>Delete</b> to remove the entry.

### 15.2.3 Overloading

Use this screen to view the Switch's LLDP port overloading. Click **Monitor > LLDP > Overloading** to access this screen.

Figure 86 Monitor > LLDP > Overloading

Port Overloading										Statistics			Remote Information	Overloading
Port	Total(Bytes)	Left to Send(Bytes)	Status	Mandatory TLVs	MED Capabilities	MED Location	MED Network Policy	Bytes Detail			802.3 TLVs	Optional TLVs	MED Inventory	802.1 TLVs
								MED Extended Power via MDI						
1	81	1407	Not Overloading	19							11	43		8
2	81	1407	Not Overloading	19							11	43		8
3	81	1407	Not Overloading	19							11	43		8
4	81	1407	Not Overloading	19							11	43		8
5	81	1407	Not Overloading	19							11	43		8
6	81	1407	Not Overloading	19							11	43		8
22	82	1406	Not Overloading	20							11	43		8
23	82	1406	Not Overloading	20							11	43		8
24	82	1406	Not Overloading	20							11	43		8
25	82	1406	Not Overloading	20							11	43		8
26	82	1406	Not Overloading	20							11	43		8

Each field is described in the following table.

Table 49 Monitor > LLDP > Overloading

LABEL	DESCRIPTION
Port Overloading	
Port	This label shows the port you are viewing.
Total (Bytes)	This field displays the total in bytes.
Left to Send (Bytes)	This field displays what is left to send in bytes.
Status	This field displays whether the Switch is overloading or not.
Bytes Detail	This field displays how many bytes used by TLVs
Mandatory TLVs	This field displays how many bytes used by mandatory TLVs.
MED Capabilities	This field displays how many bytes used by MED capabilities.
MED Location	This field displays how many bytes used by MED location.
MED Network Policy	This field displays how many bytes used by MED network policy.
MED Extended Power via MDI	This field displays how many bytes used by MED extended power via MDI.
802.3 TLVs	This field displays how many bytes used by 802.3 TLVs.
Optional TLVs	This field displays how many bytes used by optional TLVs.
MED Inventory	This field displays how many bytes used by MED inventory.
802.1 TLVs	This field displays how many bytes used by 802.1 TLVs.

# CHAPTER 16

## Monitor: Security

### 16.1 Overview

This section provides information for **Security** in **Monitor**.

This link takes you to a screen where you can view the settings or traffic statistics which contain detailed information about specific activities.

#### 16.1.1 What You Can Do in this Chapter

- The **Port Security** screen ([Section 16.2 on page 96](#)) displays global and port.
- The **802.1X** screen ([Section 16.3 on page 97](#)) displays port and authenticated hosts.

### 16.2 Port Security

Port security allows only packets with dynamically learned MAC addresses and/or configured static MAC addresses to pass through a port on the Switch. The Switch can learn up to 8K MAC addresses in total with no limit on individual ports; system total MAC address entry is 8K. Static MAC address still can be configured when port security is enabled; the function of port security is concerned with dynamic mac address learn action. When total MAC address entry is 8k, static MAC can't be configured.

Use this screen to view Switch port security settings. Click **Monitor > Security > Port Security** to access this screen.



Figure 87 Monitor &gt; Security &gt; Port Security

Port Security				
Status		Disable		
<b>Port</b>				
Port	Status	Max MAC Entry Number	Current Addr Number	Action
1	Disable	Unlimited	0	---
2	Disable	Unlimited	0	---
3	Disable	Unlimited	0	---
4	Disable	Unlimited	0	---
5	Disable	Unlimited	0	---
6	Disable	Unlimited	0	---
7	Disable	Unlimited	0	---
8	Disable	Unlimited	0	---
9	Disable	Unlimited	0	---
10	Disable	Unlimited	0	---
11	Disable	Unlimited	0	---
12	Disable	Unlimited	0	---
13	Disable	Unlimited	0	---
14	Disable	Unlimited	0	---
15	Disable	Unlimited	0	---
16	Disable	Unlimited	0	---
17	Disable	Unlimited	0	---
18	Disable	Unlimited	0	---
19	Disable	Unlimited	0	---
20	Disable	Unlimited	0	---
21	Disable	Unlimited	0	---
22	Disable	Unlimited	0	---
23	Disable	Unlimited	0	---
24	Disable	Unlimited	0	---
25	Disable	Unlimited	0	---
26	Disable	Unlimited	0	---
LAG1	Disable	Unlimited	0	---
LAG2	Disable	Unlimited	0	---
LAG3	Disable	Unlimited	0	---
LAG4	Disable	Unlimited	0	---
LAG5	Disable	Unlimited	0	---
LAG6	Disable	Unlimited	0	---
LAG7	Disable	Unlimited	0	---
LAG8	Disable	Unlimited	0	---

Each field is described in the following table.

Table 50 Monitor &gt; Security &gt; Port Security

LABEL	DESCRIPTION
Port Security	
Status	This field displays the status of global control information.
Port	
Port	This field displays a port number.
Status	This field displays the status of port based control information.
Max MAC Entry Number	Displays the designated maximum number of allowed MAC entries. The maximum MAC entry number can be learned for individual ports.
Current Addr Number	This field displays the number of the current addr.
Action	This field displays the action(s) the Switch takes on the associated classified traffic flow.

## 16.3 802.1X

Use this screen to view Switch 802.1x security settings.

### 16.3.1 Port

Use this screen to view the Switch's 802.1x port status. Click **Monitor > Security > 802.1X > Port** to access this screen.

**Figure 88** Monitor > Security > 802.1X > Port

Port Status		<a href="#">Port</a>	<a href="#">Authenticated Hosts</a>
Port	Status		
1	---		
2	---		
3	---		
4	---		
5	---		
6	---		
7	---		
8	---		
9	---		
10	---		
11	---		
12	---		
13	---		
14	---		
15	---		
16	---		
17	---		
18	---		
19	---		
20	---		
21	---		
22	---		
23	---		
24	---		
25	---		
26	---		

Each field is described in the following table.

**Table 51** Monitor > Security > 802.1X > Port

LABEL	DESCRIPTION
Port Status	
Port	This label shows the port you are viewing.
Status	This field displays status of the port.

## 16.3.2 Authenticated Hosts

Use this screen to view the Switch's 802.1x security authenticated host status. Click **Monitor > Security > 802.1X > Authenticated Hosts** to access this screen.

**Figure 89** Monitor > Security > 802.1X > Authenticated Hosts

Authenticated Hosts					<a href="#">Port</a>	<a href="#">Authenticated Hosts</a>
User Name	Port	Session Time	Authentication Method	MAC Address		

Each field is described in the following table.

**Table 52** Monitor > Security > 802.1X > Authenticated Hosts

LABEL	DESCRIPTION
Authenticated Hosts	
User Name	This field displays the name of a user.
Port	This label shows the port you are viewing.
Session Time	This label shows the session time.
Authentication Method	This label shows the authentication method.
MAC Address	This field displays the source MAC address in the binding.

# CHAPTER 17

## Monitor: Management

### 17.1 Overview

This section provides information for **Management** in **Monitor**.

This chapter describes how to view management settings on the Switch.

#### 17.1.1 What You Can Do in this Chapter

- The **Syslog** screen ([Section 17.2 on page 99](#)) displays logging filter select and shows system log.
- The **Error Disable** screen ([Section 17.3 on page 100](#)) displays global and port.

### 17.2 Syslog

Use this screen to view Switch syslog management. Click **Monitor** > **Management** > **Syslog** to access this screen.

**Figure 90** Monitor > Management > Syslog

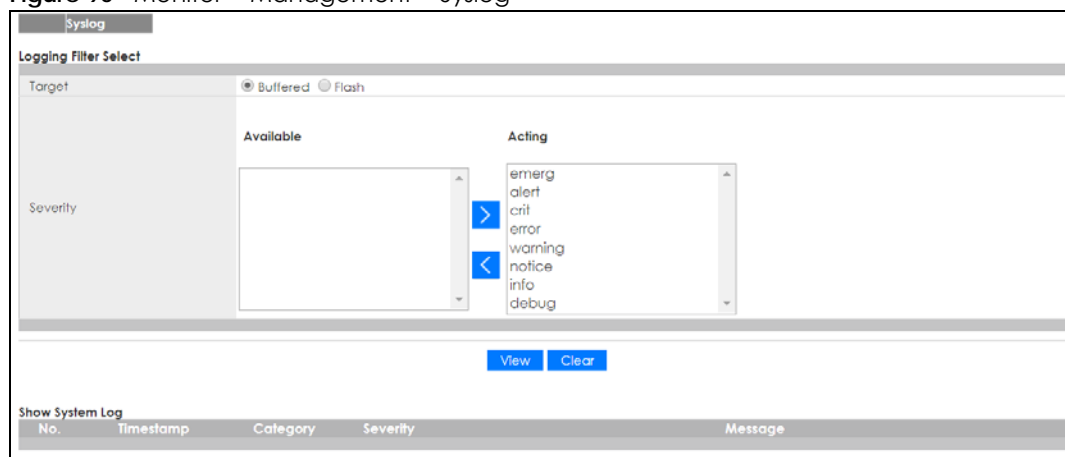

Each field is described in the following table.

**Table 53** Monitor > Management > Syslog

LABEL	DESCRIPTION
Logging Filter Select	
Target	Select <b>Buffered</b> or <b>Flash</b> . Buffered: Login saved to temporary memory. Flash: Login saved to permanent memory.

Table 53 Monitor &gt; Management &gt; Syslog

LABEL	DESCRIPTION
Severity	This field displays two options: Available and Acting. Severity type: crit, emerg, alert, error, warning, notice, info, and debug.
Available	Click < to move a severity type from the acting box to the available box. Click > to move a severity type to the acting box from the available box.
Acting	Click < to move a severity type from the acting box to the available box. Click > to move a severity type to the acting box from the available box.
>	Click > to move a severity type to the acting box from the available box.
<	Click < to move a severity type from the acting box to the available box.
View	Click <b>View</b> to display results.
Clear	Click <b>Clear</b> to clear results.
Show System Log	The syslog protocol allows devices to send event notification messages across an IP network to syslog servers that collect the event messages. A syslog-enabled device can generate a syslog message and send it to a syslog server
No.	This field displays the number you are viewing.
Timestamp	This field displays the timestamp.
Category	This field displays the category.
Severity	This field displays the severity.
Message	The syslog protocol allows devices to send event notification messages across an IP network to syslog servers that collect the event messages. A syslog-enabled device can generate a syslog message and send it to a syslog server.

## 17.3 Error Disable

This link takes you to a screen where you can view CPU protection and error disable recovery.

Use this screen to view Switch global and port error disable management. Click **Monitor > Management > Error Disable** to access this screen.

Figure 91 Monitor &gt; Management &gt; Error Disable

Error Disable			
Recovery Interval	300 sec		
<b>Reason Status</b>			
Error Disabled Reason	Timer Status		
Broadcast Flood	Disable		
Unknown Multicast Flood	Disable		
Unicast Flood	Disable		
Port Security	Disable		
<b>Port Status</b>			
Port	Error Disabled Reason	Time Left (sec)	Action
1	---	---	Recovery
2	---	---	Recovery
3	---	---	Recovery
4	---	---	Recovery
5	---	---	Recovery
6	---	---	Recovery
7	---	---	Recovery
8	---	---	Recovery
20	---	---	Recovery
LAG1	---	---	Recovery
LAG2	---	---	Recovery
LAG3	---	---	Recovery
LAG4	---	---	Recovery
LAG5	---	---	Recovery
LAG6	---	---	Recovery
LAG7	---	---	Recovery
LAG8	---	---	Recovery

Each field is described in the following table.

Table 54 Monitor &gt; Management &gt; Error Disable

LABEL	DESCRIPTION
Error Disable	
Recovery Interval	View the number of seconds (from 30 to 2592000) for the time interval of the recovery.
<b>Reason Status</b>	
Error Disabled Reason	This field displays the supported features that allow the Switch to shut down a port or discard packets on a port according to the feature requirements and what action you configure.
Timer Status	Select this option to allow the Switch to wait for the specified time interval to activate a port or allow specific packets on a port, after the error was gone. Deselect this option to turn off this rule.
<b>Port Status</b>	
Port	This field displays the port number.
Error Disabled Reason	This field displays the supported features that allow the Switch to shut down a port or discard packets on a port according to the feature requirements and what action you configure.
Time Left (sec)	This field displays the time left in seconds.
Action	This field displays the action.

# CHAPTER 18

## Configuration: System

### 18.1 Overview

This section provides information for **System** in **Configuration**.

#### 18.1.1 What You Can Do in this Chapter

- The **IP** screen (Section 18.2 on page 102) displays IPv4 and IPv6 settings.
- The **Time** screen (Section 18.3 on page 104) displays the system time and SNTP settings.
- The **Information** screen (Section 18.4 on page 105) displays the system information.

### 18.2 IP

The Switch needs an IP address for it to be managed over the network. The factory default IP address is 192.168.1.1. The subnet mask specifies the network number portion of an IP address. The factory default subnet mask is 255.255.255.0.

#### 18.2.1 The IPv4 Screen

Use this screen to view the IPv4 interface status and Switch's management IPv4 addresses. Click **Configuration > System > IP > IPv4** to open this screen.

**Figure 92** Configuration > System > IP > IPv4

IPv4 Address		IPv4	IPv6
Mode	<input checked="" type="radio"/> Static <input type="radio"/> DHCP		
IP Address	10.214.80.211		
Subnet Mask	255.255.255.0		
Gateway	0.0.0.0		
DNS 1	0.0.0.0		
DNS 2	0.0.0.0		
Management VLAN	1	(1 - 4094)	

[Apply](#) [Cancel](#)

The following table describes the labels in this screen.

Table 55 Configuration > System > IP > IPv4

LABEL	DESCRIPTION
IPv4 Address	
Mode	Select Static to define the IPv4 network properties or DHCP to allow the device to define the properties.
IP Address	Enter the IP address of the Switch in the IP domain.
Subnet Mask	Enter the subnet mask of the Switch in the IP domain.
Gateway	Enter the IP address of the default outgoing gateway in dotted decimal notation, for example 192.168.1.254.
DNS 1	Enter the IP address for the primary domain name server. DNS (Domain Name System) is for mapping a domain name to its corresponding IP address and vice versa.
DNS 2	Enter the IP address for the secondary domain name server. DNS (Domain Name System) is for mapping a domain name to its corresponding IP address and vice versa.
Management VLAN	Enter the port number of the management VLAN.
Apply	Click <b>Apply</b> to save the changes.
Cancel	Click <b>Cancel</b> to discard the changes.

## 18.2.2 The IPv6 Screen

Use this screen to view the IPv6 interface status and Switch's management IPv6 addresses.

Click **Configuration > System > IP > IPv6** to open this screen.

Figure 93 Configuration > System > IP > IPv6

The following table describes the labels in this screen.

Table 56 Configuration > System > IP > IPv6

LABEL	DESCRIPTION
IPv6 Address	
DHCPv6 Client	Select <b>Enable</b> to allow the device to act as a DHCPv6 client or <b>Disable</b> to disallow it. This field displays the Switch's DHCP settings when it is acting as a DHCPv6 client.
Auto Configuration	Select <b>Enable</b> to allow the device to auto-configure the IPv6 properties or <b>Disable</b> to manually enter the properties.
IPv6 Address	Enter the IPv6 address of the Switch in the IP domain.
Gateway	Enter the IPv6 address of the default outgoing gateway.

Table 56 Configuration &gt; System &gt; IP &gt; IPv6 (continued)

LABEL	DESCRIPTION
Apply	Click <b>Apply</b> to save the changes.
Cancel	Click <b>Cancel</b> to discard the changes.

## 18.3 Time

The Time option is used to setup the system time and SNTP (Simple Network Time Protocol) server settings.

### 18.3.1 The System Time Screen

In the navigation panel, click **Configuration > System > Time > System Time** to display the screen as shown.

Figure 94 Configuration &gt; System &gt; Time &gt; System Time

The following table describes the labels in this screen.

Table 57 Configuration &gt; System &gt; Time &gt; System Time

LABEL	DESCRIPTION
System Time	
Enable SNTP	Select <b>Enable</b> to enable using a simple network time protocol (SNTP) server to manage the system time or <b>Disable</b> to manually manage system time.
Manual Time	Select the system date and time values from the dropdown lists.
Time Zone	Select the time zone from the dropdown list.
Daylight Saving Time	Select <b>Enable</b> to use Daylight Saving Time to offset the system time or <b>Disable</b> to not adjust system time.
Daylight Saving Time Offset	Enter the daylight saving time offset value in minutes.
Start Date	Select the start date of the daylight saving time period from the dropdown lists.
End Date	Select the end date of the daylight saving time period from the dropdown lists.
Apply	Click <b>Apply</b> to save the changes.
Cancel	Click <b>Cancel</b> to discard the changes.



## 18.3.2 The SNTP Server Screen

In the navigation panel, click **Configuration > System > Time > SNTP Server** to display the screen as shown.

**Figure 95** Configuration > System > Time > SNTP Server

SNTP Server		<a href="#">System Time</a>	<a href="#">SNTP Server</a>
Server	<input type="text"/>	( X.X.X.X or Hostname )	
Server Port	123	( 1 - 65535 )	
<input type="button" value="Apply"/> <input type="button" value="Cancel"/>			

The following table describes the labels in this screen.

Table 58 Configuration > System > Time > SNTP Server

LABEL	DESCRIPTION
SNTP Server	
Server	Enter the address of the simple network time protocol (SNTP) server as an IP address (192.168.0.1) or as a URL (www.zyxel.com).
Server Port	Enter the port number of the SNTP server. The numeric value can be between 1 and 65535.
Apply	Click <b>Apply</b> to save the changes.
Cancel	Click <b>Cancel</b> to discard the changes.

## 18.4 Information

The information option is used to set the following system information properties: system name, system location, and system contact information.

### 18.4.1 The System Information Screen

In the navigation panel, click **Configuration > System > Information > System Information** to display the screen as shown. You can set the system name, system location, and system contact.

**Figure 96** Configuration > System > Information > System Information

System Information	
System Name	GS1900
System Location	Location
System Contact	Contact
<input type="button" value="Apply"/> <input type="button" value="Cancel"/>	

The following table describes the labels in this screen.

Table 59 Configuration > System > Information > System Information

LABEL	DESCRIPTION
System Information	
System Name	Enter the descriptive name of the Switch for identification purposes.
System Location	Enter the geographic location of the Switch for identification purposes.
System Contact	Enter the person in charge of the Switch for identification purposes.
Apply	Click <b>Apply</b> to save the changes.
Cancel	Click <b>Cancel</b> to discard the changes.

# CHAPTER 19

## Configuration: Port

### 19.1 Overview

This section provides information for **Port** in **Configuration**.

#### 19.1.1 What You Can Do in this Chapter

- The **Port** screen ([Section 19.2 on page 107](#)) displays general port settings.
- The **EEE** screen ([Section 19.3 on page 109](#)) displays the port EEE settings.
- The **PoE** screen ([Section 19.4 on page 111](#)) displays the port PoE settings.
- The **Bandwidth Management** screen ([Section 19.5 on page 116](#)) displays the port ingress and egress settings.
- The **Storm Control** screen ([Section 19.6 on page 117](#)) displays the port storm control settings.

### 19.2 Port

Use this screen to view and edit general port settings

#### 19.2.1 The Port Screen

Use this screen to view Switch port settings and select ports for configuration. Click **Configuration > Port > Port** to open this screen.

Figure 97 Configuration &gt; Port &gt; Port

<input type="checkbox"/>	Port	Port Name	State	Link Status	Speed	Duplex	FlowCtrl State
<input type="checkbox"/>	1		Enable	Down	Auto	Auto	Disable
<input type="checkbox"/>	2		Enable	Down	Auto	Auto	Disable
<input type="checkbox"/>	3		Enable	Down	Auto	Auto	Disable
<input type="checkbox"/>	4		Enable	Down	Auto	Auto	Disable
<input type="checkbox"/>	5		Enable	Down	Auto	Auto	Disable
<input type="checkbox"/>	6		Enable	Down	Auto	Auto	Disable
<input type="checkbox"/>	7		Enable	Down	Auto	Auto	Disable
<input type="checkbox"/>	8		Enable	Down	Auto	Auto	Disable
<input type="checkbox"/>	9		Enable	Down	Auto	Auto	Disable
<input type="checkbox"/>	10		Enable	Down	Auto	Auto	Disable
<input type="checkbox"/>	22		Enable	Down	Auto	Auto	Disable
<input type="checkbox"/>	23		Enable	Down	Auto	Auto	Disable
<input type="checkbox"/>	24		Enable	Up	Auto	Auto	Disable
<input type="checkbox"/>	25		Enable	Down	Auto	Auto	Disable
<input type="checkbox"/>	26		Enable	Down	Auto	Auto	Disable

The following table describes the labels in this screen.

Table 60 Configuration &gt; Port &gt; Port

LABEL	DESCRIPTION
Port	
Port	Displays the port index number.
Port Name	Displays a descriptive name that identifies this port. The length of the name can be up to 32 alpha-numerical characters.  Note: Due to space limitations, the port name may be truncated in some web configurator screens.
State	Displays the port status as enabled or disabled.
Link Status	Displays the link status as up or down.
Speed	Displays the speed of the Ethernet connection on this port. The choices are <b>Auto</b> , <b>10M</b> , <b>100M</b> , and <b>1000M</b> .
Duplex	Displays the duplex mode of the Ethernet connection on this port. The choices are <b>auto</b> , <b>full</b> , or <b>half</b> .
FlowCtrl State	Displays the flow control state as enabled or disabled. A concentration of traffic on a port decreases port bandwidth and overflows buffer memory causing packet discards and frame losses. Flow Control is used to regulate transmission of signals to match the bandwidth of the receiving port.
Edit	Select this check box to configure the properties of a port. Click the <b>Edit</b> button change the properties of the port.
Cancel	Click <b>Cancel</b> to discard the changes.

## 19.2.2 The Port Edit Screen

Use this screen to configure Switch port settings. Click **Configuration > Port > Port > Edit** to open this screen.

Figure 98 Configuration &gt; Port &gt; Port &gt; Edit

Port	
Port List	16
Port Name	<input type="text"/>
State	<input checked="" type="radio"/> Enable <input type="radio"/> Disable
Speed	<input checked="" type="radio"/> Auto <input type="radio"/> 10M <input type="radio"/> 100M <input type="radio"/> 1000M
Duplex	<input checked="" type="radio"/> Auto <input type="radio"/> Full <input type="radio"/> Half
Flow Control	<input type="radio"/> Enable <input checked="" type="radio"/> Disable
<input type="button" value="Apply"/> <input type="button" value="Cancel"/>	

The following table describes the labels in this screen.

Table 61 Configuration &gt; Port &gt; Port &gt; Edit

LABEL	DESCRIPTION
Port	
Port List	Displays the list of port index numbers that are being configured.
Port Name	Enter a descriptive name that identifies this port. The length of the name can be up to 32 alpha-numerical characters.  Note: Due to space limitations, the port name may be truncated in some web configurator screens.
State	Select <b>Enable</b> to enable the ports or <b>Disable</b> to disable them.
Speed	Select the speed of the Ethernet connection on this port. The choices are <b>Auto</b> , <b>10M</b> , <b>100M</b> , and <b>1000M</b> .
Duplex	Select the duplex mode of the Ethernet connection on this port. The choices are <b>Auto</b> , <b>Full</b> , or <b>Half</b> .
FlowCtrl State	Select <b>Enable</b> to allow the device to manage data flow or <b>Disable</b> to have no data flow management. A concentration of traffic on a port decreases port bandwidth and overflows buffer memory causing packet discards and frame losses. Flow Control is used to regulate transmission of signals to match the bandwidth of the receiving port.
Apply	Click <b>Apply</b> to save the changes.
Cancel	Click <b>Cancel</b> to discard the changes.

## 19.3 EEE

Use this screen to view and edit the port EEE settings.

### 19.3.1 The EEE Screen

Use this screen to view Switch port Energy-Efficient Ethernet (EEE) settings and select ports for configuration. Click **Configuration > Port > EEE > EEE** to open this screen.

**Figure 99** Configuration > Port > EEE > EEE

EEE		
<input type="checkbox"/>	Port	State
<input type="checkbox"/>	1	Disable
<input type="checkbox"/>	2	Disable
<input type="checkbox"/>	3	Disable
<input type="checkbox"/>	4	Disable
<input type="checkbox"/>	5	Disable
<input type="checkbox"/>	6	Disable
<input type="checkbox"/>	7	Disable
<input type="checkbox"/>	21	Disable
<input type="checkbox"/>	22	Disable
<input type="checkbox"/>	23	Disable
<input type="checkbox"/>	24	Disable
<input type="checkbox"/>	25	Disable
<input type="checkbox"/>	26	Disable

The following table describes the labels in this screen.

**Table 62** Configuration > Port > EEE > EEE

LABEL	DESCRIPTION
EEE	
Port	Displays the port index number.
State	Displays the port status as enabled or disabled.
Edit	Select this check box to configure the properties of a port. Click the <b>Edit</b> button change the properties of the port.
Cancel	Click <b>Cancel</b> to discard the changes.

### 19.3.2 The EEE Edit Screen

Use this screen to configure Switch port EEE settings. Click **Configuration > Port > EEE > EEE > Edit** to open this screen.

**Figure 100** Configuration > Port > EEE > EEE > Edit

The following table describes the labels in this screen.

**Table 63** Configuration > Port > EEE > EEE > Edit

LABEL	DESCRIPTION
EEE	
Port List	Displays the list of port index numbers that are being configured.
State	Select <b>Enable</b> to designate the ports as EEE or <b>Disable</b> to not designate them as EEE.
Apply	Click <b>Apply</b> to save the changes.
Cancel	Click <b>Cancel</b> to discard the changes.

## 19.4 PoE

The Switch supports both the IEEE 802.3af Power over Ethernet (PoE) and IEEE 802.3at High Power over Ethernet (PoE) standards. The Switch is Power Sourcing Equipment (PSE) because it provides a source of power via its Ethernet ports, and each device that receives power through an Ethernet port is a Powered Device (PD).

### 19.4.1 The Global Screen

In the navigation panel, click **Configuration > Port > PoE > Global** to display the screen as shown. Use this screen to configure Power over Ethernet (PoE) global settings.

**Figure 101** Configuration > Port > PoE > Global

The following table describes the labels in this screen.

Table 64 Configuration &gt; Port &gt; PoE &gt; Global

LABEL	DESCRIPTION
PoE Mode	Select the power management mode you want the Switch to use. <ul style="list-style-type: none"> <li><b>Classification</b> - Select this if you want the Switch to reserve the Max Power (mW) to each PD according to the priority level. If the total power supply runs out, PDs with lower priority do not get power to function.</li> <li><b>Consumption</b> - Select this if you want the Switch to manage the total power supply so that each connected PD gets a resource. However, the power allocated by the Switch may be less than the Max Power (mW) of the PD. PDs with higher priority also get more power than those with lower priority levels.</li> </ul>
Pre-Allocate	This field is only available on GS1900-8HP (Revision B1) and GS1900-10HP only.  Select <b>Enable</b> to have the Switch pre-allocate power to each port based on the classification of the PD device. Otherwise, select <b>Disable</b> .
Power Up Sequence Delay	This field is only available on GS1900-8HP (Revision B1) and GS1900-10HP only.  Select <b>Enable</b> to allow PoE ports to be powered up one-by-one randomly or <b>Disable</b> to allow them all to be powered up at the same time.
Apply	Click <b>Apply</b> to save the changes.
Cancel	Click <b>Cancel</b> to discard the changes.

## 19.4.2 The Port Screen

Use this screen to view Switch port PoE settings and select ports for configuration. Click **Configuration > Port > PoE > Port** to open this screen.

Figure 102 Configuration &gt; Port &gt; PoE &gt; Port

PoE Port										Global	Port
<input type="checkbox"/>	Port	State	Class	PD Priority	Power-Up	Wide Range Detection	Consuming Power (mW)	Max Power (mW)	Time Range Name	Status	
<input type="checkbox"/>	1	Enable	class0	Low	802.3at	Disable	0	0	-	-	
<input type="checkbox"/>	2	Enable	class0	Low	802.3at	Disable	0	0	-	-	
<input type="checkbox"/>	3	Enable	class0	Low	802.3at	Disable	0	0	-	-	
<input type="checkbox"/>	4	Enable	class0	Low	802.3at	Disable	0	0	-	-	
<input type="checkbox"/>	5	Enable	class0	High	802.3at	Disable	0	0	-	-	
<input type="checkbox"/>	6	Enable	class0	High	802.3at	Disable	0	0	-	-	
<input type="checkbox"/>	7	Enable	class0	High	802.3at	Disable	0	0	-	-	
<input type="checkbox"/>	8	Enable	class0	Low	802.3at	Disable	0	0	-	-	
<input type="checkbox"/>	9	Enable	class0	Low	802.3a	Disable	0	0	-	-	
<input type="checkbox"/>	20	Enable	class0	Low	802.3a	Disable	0	0	-	-	
<input type="checkbox"/>	21	Enable	class0	Low	802.3a	Disable	0	0	-	-	
<input type="checkbox"/>	22	Enable	class0	Low	802.3a	Disable	0	0	-	-	
<input type="checkbox"/>	23	Enable	class0	Low	802.3a	Disable	0	0	-	-	
<input type="checkbox"/>	24	Enable	class0	Low	802.3a	Disable	0	0	-	-	

The following table describes the labels in this screen.

Table 65 Configuration &gt; Port &gt; PoE &gt; Port

LABEL	DESCRIPTION
Edit	Select one or more ports in the first column of the table and click this to configure PoE settings for the ports.
Port	Displays the port index number.



Table 65 Configuration &gt; Port &gt; PoE &gt; Port (continued)

LABEL	DESCRIPTION
State	<p>Displays which ports can receive power from the Switch. You can set this in the <b>Configuration &gt; Port &gt; PoE Edit</b> screen.</p> <ul style="list-style-type: none"> <li>• <b>Disable</b> - The powered device (PD) connected to this port cannot get power.</li> <li>• <b>Enable</b> - The PD connected to this port can receive power.</li> </ul>
Class	<p>This shows the power classification of the PD.</p> <p>This is a number from 0 to 4, where each value represents a range of power (W) and current (mA) that the PD requires to function. The ranges are as follows.</p> <ul style="list-style-type: none"> <li>• <b>Class 0</b> - Default, 0.44 to 12.94</li> <li>• <b>Class 1</b> - Optional, 0.44 to 3.84</li> <li>• <b>Class 2</b> - Optional, 3.84 to 6.49</li> <li>• <b>Class 3</b> - Optional, 6.49 to 12.95</li> <li>• <b>Class 4</b> - Reserved (PSEs classify as Class 0) in a switch that supports IEEE 802.3af only. Optional, 12.95 to 25.50 in a switch that supports IEEE 802.3at.</li> </ul>
PD Priority	<p>When the total power requested by the PDs exceeds the total PoE power budget on the Switch, you can set the PD priority to allow the Switch to provide power to ports with higher priority first.</p> <ul style="list-style-type: none"> <li>• <b>Critical</b> has the highest priority.</li> <li>• <b>High</b> has the Switch assign power to the port after all critical priority ports are served.</li> <li>• <b>Medium</b> has the Switch assign power to the port after all critical and high priority ports are served.</li> <li>• <b>Low</b> has the Switch assign power to the port after all critical, high and medium priority ports are served.</li> </ul>
Power-Up	<p>This shows how the Switch provides power to the connected PD at power-up.</p> <p><b>802.3af</b> - the Switch follows the IEEE 802.3af Power over Ethernet standard to supply power to the connected PDs during power-up.</p> <p><b>Legacy</b> - the Switch can provide power to the connected PDs that require high inrush currents at power-up.</p> <p><b>Pre-802.3at</b> - the Switch initially offers power on the port according to the IEEE 802.3af standard, and then switches to support the IEEE 802.3at standard within 75 milliseconds after a PD is connected to the port. Select this option if the Switch is performing 2-event Layer-1 classification (PoE+ hardware classification) or the connected PD is NOT performing Layer 2 power classification using Link Layer Discovery Protocol (LLDP).</p> <p><b>802.3at</b> - the Switch supports the IEEE 802.3at High Power over Ethernet standard and can supply power of up to 30W per Ethernet port. IEEE 802.3at is also known as PoE+ or PoE Plus. An IEEE 802.3at compatible device is referred to as Type 2. Power Class 4 (High Power) can only be used by Type 2 devices. If the connected PD requires a Class 4 current when it is turned on, it will be powered up in this mode.</p>
Wide Range Detection	<p>This field is available on GS1900-8HP (Revision B1) and GS1900-10HP only.</p> <p>This shows whether the Switch enables a wider detection range for the PD or not.</p> <p>The Switch detects whether a connected device is a powered device or not before supplying power to the port. For the PD detection, the Switch applies a fixed voltage to the device and then receives returned current. If the returned current is within the IEEE 802.3AF/AT standard range, the device will be considered as a valid PD by the Switch.</p> <p>However, in real cases, environmental interferences might easily cause the returned current out of the standard range. This field displays <b>Enable</b> if the Switch applies a wider range for PD detection. Otherwise, it displays <b>Disable</b>.</p>
Consuming Power (mW)	This field displays the current amount of power consumed by the PD from the Switch on this port.
Max Power (mW)	This field displays the maximum amount of power the PD could use from the Switch on this port.
Time Range	

Table 65 Configuration &gt; Port &gt; PoE &gt; Port (continued)

LABEL	DESCRIPTION
Name	This field displays the name of the time range (schedule) rule which is applied to the port. PoE is enabled at the specified time/date.
Status	This field displays whether the port can receive power from the Switch ( <b>In</b> ) or not ( <b>Out</b> ) currently. It shows - if there is no schedule applied to the port.

### 19.4.3 The PoE Edit Screen

Use this screen to configure Switch port PoE settings. Select a port and click **Edit** in the **Configuration > Port > PoE > Port** screen to open this screen.

Figure 103 Configuration &gt; Port &gt; PoE &gt; Port &gt; Edit

The following table describes the labels in this screen.

Table 66 Configuration &gt; Port &gt; PoE &gt; Port &gt; Edit

LABEL	DESCRIPTION
PoE Port	
Port List	Displays the list of port index numbers that are being configured.
PD State	Select <b>Enable</b> to provide power to a PD connected to the port or <b>Disable</b> so the port cannot receive power from the Switch.
PD Priority	<p>This field is not available for the SFP or SFP+ ports.</p> <p>When the total power requested by the PDs exceeds the total PoE power budget on the Switch, you can set the PD priority to allow the Switch to provide power to ports with higher priority.</p> <p>Select <b>Critical</b> to give the PD connected to this port the highest priority.</p> <p>Select <b>High</b> to set the Switch to assign the remaining power to the port after all critical priority ports are served.</p> <p>Select <b>Medium</b> to set the Switch to assign the remaining power to the port after all critical and high priority ports are served.</p> <p>Select <b>Low</b> to set the Switch to assign the remaining power to the port after all critical, high and medium priority ports are served.</p>

Table 66 Configuration &gt; Port &gt; PoE &gt; Port &gt; Edit (continued)

LABEL	DESCRIPTION
Power-Up	<p>Set how the Switch provides power to a connected PD at power-up.</p> <p><b>802.3af</b> - the Switch follows the IEEE 802.3af Power over Ethernet standard to supply power to the connected PDs during power-up.</p> <p><b>Legacy</b> - the Switch can provide power to the connected PDs that require high inrush currents at power-up.</p> <p><b>Pre-802.3at</b> - the Switch initially offers power on the port according to the IEEE 802.3af standard, and then switches to support the IEEE 802.3at standard within 75 milliseconds after a PD is connected to the port. Select this option if the Switch is performing 2-event Layer-1 classification (PoE+ hardware classification) or the connected PD is NOT performing Layer 2 power classification using Link Layer Discovery Protocol (LLDP).</p> <p><b>802.3at</b> - the Switch supports the IEEE 802.3at High Power over Ethernet standard and can supply power of up to 30W per Ethernet port. IEEE 802.3at is also known as PoE+ or PoE Plus. An IEEE 802.3at compatible device is referred to as Type 2. Power Class 4 (High Power) can only be used by Type 2 devices. If the connected PD requires a Class 4 current when it is turned on, it will be powered up in this mode.</p>
Wide Range Detection	<p>This field is available on the GS1900-8HP (Revision B1) and GS1900-10HP only.</p> <p>Select whether to enable a wider detection range for the PD or not.</p> <p>The Switch detects whether a connected device is a powered device or not before supplying power to the port. For the PD detection, the Switch applies a fixed voltage to the device and then receives returned current. If the returned current is within the IEEE 802.3AF/AT standard range, the device will be considered as a valid PD by the Switch.</p> <p>However, in real cases, environmental interferences might easily cause the returned current out of the standard range. This field displays <b>Enable</b> if the Switch applies a wider range for PD detection. Otherwise, it displays <b>Disable</b>.</p>
Max Power Type	<p>Select <b>Classification-based</b> to have the Switch automatically decide the maximum amount of power it can provide on the port according to the connected PD's power classification.</p> <p>Select <b>User-defined</b> to manually specify the maximum amount of power the PD could use from the Switch on this port.</p>
Max Power Threshold	<p>Specify the maximum amount of power the Switch can provide on the port if you set <b>Max Power Type</b> to <b>User-defined</b>.</p> <p>Enter a value between 1000 and 33000 in increments of 200.</p>
Time Range	<p>Select a pre-defined schedule (created using the <b>Time Range</b> screen) to control when the Switch enables PoE to provide power on the port.</p> <p>If you leave this field blank, there is no schedule applied to the port.</p>
Apply	<p>Click <b>Apply</b> to save the changes.</p>
Cancel	<p>Click <b>Cancel</b> to discard the changes.</p>

## 19.5 Bandwidth Management

Bandwidth management means defining a maximum allowable bandwidth for incoming and/or outgoing traffic flows on a port.

### 19.5.1 The Bandwidth Control Screen

Use this screen to view Egress Bandwidth Management settings and select ports for configuration. Click **Configuration > Port > Bandwidth Management > Egress Global Burst** to open this screen.

**Figure 104** Configuration > Port > Bandwidth Management > Egress Global Burst

Egress Global Burst			
Egress Global Burst	40000	(4578-50000, unit: Byte)	
<input type="button" value="Apply"/> <input type="button" value="Cancel"/>			
Port Rate			
<input type="checkbox"/>	Port	Ingress RateLimit (Kbps)	Egress RateLimit (Kbps)
<input type="checkbox"/>	1	Disable	Disable
<input type="checkbox"/>	2	Disable	Disable
<input type="checkbox"/>	3	Disable	Disable
<input type="checkbox"/>	4	Disable	Disable
<input type="checkbox"/>	5	Disable	Disable
<input type="checkbox"/>	6	Disable	Disable
<input type="checkbox"/>	7	Disable	Disable
<input type="checkbox"/>	22	Disable	Disable
<input type="checkbox"/>	23	Disable	Disable
<input type="checkbox"/>	24	Disable	Disable
<input type="checkbox"/>	25	Disable	Disable
<input type="checkbox"/>	26	Disable	Disable
<input type="button" value="Edit"/> <input type="button" value="Cancel"/>			

The following table describes the labels in this screen.

**Table 67** Configuration > Port > Bandwidth Management > Egress Global Burst

LABEL	DESCRIPTION
Egress Global Burst	
Egress Global Burst	Specify the current egress burst size in bytes for all ports.
Port Rate	
Port	Displays the port index number.
Ingress Rate Limit (Kbps)	Displays the maximum bandwidth allowed in kilobits per second (Kbps) for the incoming traffic flow on a port.
Egress Rate Limit (Kbps)	Displays the maximum bandwidth allowed in kilobits per second (Kbps) for the outgoing traffic flow on a port.

Table 67 Configuration &gt; Port &gt; Bandwidth Management &gt; Egress Global Burst (continued)

LABEL	DESCRIPTION
Edit	Select this check box to configure the properties of a port. Click the <b>Edit</b> button change the properties of the port.
Cancel	Click <b>Cancel</b> to discard the changes.

## 19.5.2 The Port Rate Edit Screen

Use this screen to configure port rate Bandwidth Management settings. Click **Configuration > Port > Bandwidth Management > Egress Global Burst > Edit** to open this screen.

Figure 105 Configuration &gt; Port &gt; Bandwidth Management &gt; Egress Global Burst &gt; Edit

The following table describes the labels in this screen.

Table 68 Configuration &gt; Port &gt; Bandwidth Management &gt; Egress Global Burst &gt; Edit

LABEL	DESCRIPTION
Port Rate	
Port List	Displays the list of port index numbers that are being configured.
Ingress State	Select <b>Enable</b> to activate ingress peak rate limits on the port(s).
Ingress Bandwidth (Kbps)	Enter the maximum bandwidth allowed in kilobits per second (Kbps) for the outgoing traffic flow on a port.
Egress State	Select <b>Enable</b> to activate egress peak rate limits on the port(s).
Egress Bandwidth (Kbps)	Enter the maximum bandwidth allowed in kilobits per second (Kbps) for the outgoing traffic flow on a port.
Apply	Click <b>Apply</b> to save the changes.
Cancel	Click <b>Cancel</b> to discard the changes.

## 19.6 Storm Control

Broadcast storm control limits the number of broadcast, multicast and destination lookup failure (DLF) packets the Switch receives per second on the ports. When the maximum number of allowable broadcast, multicast and/or DLF packets is reached per second, the subsequent packets are discarded. Enable this feature to reduce broadcast, multicast and/or DLF packets in your network. You can specify limits for each packet type on each port.

## 19.6.1 The Port Screen

Use this screen to view Storm Control settings for individual ports. Click **Configuration > Port > Storm Control > Storm Control** to open this screen.

**Figure 106** Configuration > Port > Storm Control > Storm Control

Storm Control						
<input type="checkbox"/>	Port	State	Broadcast (pps)	Unknown Multicast (pps)	Unknown Unicast (pps)	Action
<input type="checkbox"/>	1	Disable	Disable	Disable	Disable	Drop
<input type="checkbox"/>	2	Disable	Disable	Disable	Disable	Drop
<input type="checkbox"/>	3	Disable	Disable	Disable	Disable	Drop
<input type="checkbox"/>	4	Disable	Disable	Disable	Disable	Drop
<input type="checkbox"/>	5	Disable	Disable	Disable	Disable	Drop
<input type="checkbox"/>	6	Disable	Disable	Disable	Disable	Drop
<input type="checkbox"/>	7	Disable	Disable	Disable	Disable	Drop
<input type="checkbox"/>	8	Disable	Disable	Disable	Disable	Drop
<input type="checkbox"/>	9	Disable	Disable	Disable	Disable	Drop
<input type="checkbox"/>	10	Disable	Disable	Disable	Disable	Drop
<input type="checkbox"/>	11	Disable	Disable	Disable	Disable	Drop
<input type="checkbox"/>	12	Disable	Disable	Disable	Disable	Drop
<input type="checkbox"/>	13	Disable	Disable	Disable	Disable	Drop
<input type="checkbox"/>	14	Disable	Disable	Disable	Disable	Drop
<input type="checkbox"/>	15	Disable	Disable	Disable	Disable	Drop
<input type="checkbox"/>	16	Disable	Disable	Disable	Disable	Drop
<input type="checkbox"/>	17	Disable	Disable	Disable	Disable	Drop
<input type="checkbox"/>	18	Disable	Disable	Disable	Disable	Drop
<input type="checkbox"/>	19	Disable	Disable	Disable	Disable	Drop
<input type="checkbox"/>	20	Disable	Disable	Disable	Disable	Drop
<input type="checkbox"/>	21	Disable	Disable	Disable	Disable	Drop
<input type="checkbox"/>	22	Disable	Disable	Disable	Disable	Drop
<input type="checkbox"/>	23	Disable	Disable	Disable	Disable	Drop
<input type="checkbox"/>	24	Disable	Disable	Disable	Disable	Drop
<input type="checkbox"/>	25	Disable	Disable	Disable	Disable	Drop
<input type="checkbox"/>	26	Disable	Disable	Disable	Disable	Drop

The following table describes the labels in this screen.

**Table 69** Configuration > Port > Storm Control > Storm Control

LABEL	DESCRIPTION
Storm Control	
Port	Displays the port index number.
State	Displays whether the traffic storm control on the Switch is enabled or disabled.
Broadcast (pps)	Displays how many broadcast packets the port receives per second.
Unknown Multicast (pps)	Displays how many multicast packets the port receives per second.
Unknown Unicast (pps)	Displays how many unicast packets the port receives per second.
Action	Displays the action the device takes when a limit is reached. The following options are available: <ul style="list-style-type: none"> <li>• <b>Drop</b> - drop the packet.</li> <li>• <b>Shutdown</b> - shutdown the connection.</li> </ul>
Edit	Select this check box to configure the properties of a port. Click the <b>Edit</b> button change the properties of the port.
Cancel	Click <b>Cancel</b> to discard the changes.

## 19.6.2 The Port Edit Screen

Use this screen to configure Storm Control settings for individual ports. Click **Configuration > Port > Storm Control > Storm Control > Edit** to open this screen.

Figure 107 Configuration &gt; Port &gt; Storm Control &gt; Storm Control &gt; Edit

Storm Control Port	
Port List	
State	<input type="radio"/> Enable <input checked="" type="radio"/> Disable
Action	<input checked="" type="radio"/> Drop <input type="radio"/> Shutdown
Broadcast	<input type="checkbox"/> Enable 10000 (unit:pps)
Unknown Multicast	<input type="checkbox"/> Enable 10000 (unit:pps)
Unknown Unicast	<input type="checkbox"/> Enable 10000 (unit:pps)
<input type="button" value="Apply"/> <input type="button" value="Cancel"/>	

The following table describes the labels in this screen.

Table 70 Configuration &gt; Port &gt; Storm Control &gt; Storm Control &gt; Edit

LABEL	DESCRIPTION
Storm Control Port	
Port List	Displays the port list index number(s).
State	Select <b>Enable</b> to activate traffic storm control on the port(s).
Action	Determines the action the device takes when a limit is reached. The following options are available: <ul style="list-style-type: none"> <li>• <b>Drop</b> - drop the packet when limit is reached.</li> <li>• <b>Shutdown</b> - shutdown the connection when a limit is reached.</li> </ul>
Broadcast (pps)	Click the <b>Enable</b> checkbox to activate the feature. Enter the maximum number of broadcast packets the port can receive per second.
Unknown Multicast (pps)	Click the <b>Enable</b> checkbox to activate the feature. Enter the maximum number of multicast packets the port can receive per second.
Unknown Unicast (pps)	Click the <b>Enable</b> checkbox to activate the feature. Enter the maximum number of unicast packets the port can receive per second.
Apply	Click <b>Apply</b> to save the changes.
Cancel	Click <b>Cancel</b> to discard the changes.

# CHAPTER 20

## Configuration: VLAN

### 20.1 Overview

This section provides information for **VLAN** in **Configuration**.

A VLAN (Virtual Local Area Network) allows a physical network to be partitioned into multiple logical networks. Devices on a logical network belong to one group. A device can belong to more than one group. With VLAN, a device cannot directly talk to or hear from devices that are not in the same group(s); the traffic must first go through a router.

In MTU (Multi-Tenant Unit) applications, VLAN is vital in providing isolation and security among the subscribers. When properly configured, VLAN prevents one subscriber from accessing the network resources of another on the same LAN, thus a user will not see the printers and hard disks of another user on the same network.

VLAN also increases network performance by limiting broadcasts to a smaller and more manageable logical broadcast domain. In traditional switched environments, all broadcast packets go to each and every individual port. With VLAN, all broadcasts are confined to a specific broadcast domain.

#### 20.1.1 What You Can Do in this Chapter

- The **VLAN** screen ([Section 20.2 on page 121](#)) displays VLAN, port, and VLAN port settings.
- The **Guest VLAN** screen ([Section 20.3 on page 126](#)) displays the global and port settings of the Switch.
- The **Voice VLAN** screen ([Section 20.4 on page 128](#)) displays the global, OUI, and port settings of the Switch.



## 20.2 VLAN

Use this screen to view and configure VLAN settings.

### 20.2.1 The VLAN Screen

Use this screen to view VLAN settings. Click **Configuration > VLAN > VLAN > VLAN** to open this screen.

**Figure 108** Configuration > VLAN > VLAN > VLAN

VLAN		<a href="#">VLAN</a>	<a href="#">Port</a>	<a href="#">VLAN Port</a>
VLAN ID	VLAN Name	VLAN Type	Action	
1	default	Default		
<a href="#">Add</a>				

The following table describes the labels in this screen.

**Table 71** Configuration > VLAN > VLAN > VLAN

LABEL	DESCRIPTION
VLAN	
VLAN ID	Displays the VLAN ID number.
VLAN Name	Displays a descriptive name for the VLAN group for identification purposes. This name consists of up to 64 printable characters; spaces are allowed.
VLAN Type	Displays <b>Default</b> or <b>Static</b> .
Action	
Edit	Click <b>Edit</b> to make changes to the entry.
Add	Click <b>Add</b> to create a new VLAN entry.

### 20.2.2 The VLAN Add Screen

Use this screen to add a VLAN. Click **Configuration > VLAN > VLAN > VLAN > Add** to open this screen.

**Figure 109** Configuration > VLAN > VLAN > VLAN > Add

VLAN		<a href="#">VLAN</a>	<a href="#">Port</a>	<a href="#">VLAN Port</a>
VLAN List	<input type="text"/>			
VLAN Name Prefix	<input type="text"/>			
<a href="#">Apply</a> <a href="#">Cancel</a>				

The following table describes the labels in this screen.

Table 72 Configuration &gt; VLAN &gt; VLAN &gt; VLAN &gt; Add

LABEL	DESCRIPTION
VLAN	
VLAN List	Enter the VLAN ID number(s).  Use a dash to associate consecutive VLANs and a comma (no spaces) to associate non-consecutive VLANs. For example, 51-53 includes 51, 52 and 53, but 51,53 does not include 52.
VLAN Name Prefix	Enter a prefix for the VLAN name.
Apply	Click <b>Apply</b> to save the changes.
Cancel	Click <b>Cancel</b> to discard the changes.

### 20.2.3 The Port Screen

Use this screen to view port settings and select VLANs for configuration. Click **Configuration > VLAN > VLAN > Port** to open this screen.

Figure 110 Configuration &gt; VLAN &gt; VLAN &gt; Port

Port					<a href="#">VLAN</a>	<a href="#">Port</a>	<a href="#">VLAN Port</a>
<input type="checkbox"/>	Port	PVID	Accept Frame Type	Ingress Check	VLAN Trunk		
<input type="checkbox"/>	1	1	ALL	Disable	Disable		
<input type="checkbox"/>	2	1	ALL	Disable	Disable		
<input type="checkbox"/>	3	1	ALL	Disable	Disable		
<input type="checkbox"/>	4	1	ALL	Disable	Disable		
<input type="checkbox"/>	5	1	ALL	Disable	Disable		
<input type="checkbox"/>	6	1	ALL	Disable	Disable		
<input type="checkbox"/>	7	1	ALL	Disable	Disable		
<input type="checkbox"/>	25	1	ALL	Disable	Disable		
<input type="checkbox"/>	26	1	ALL	Disable	Disable		
<input type="checkbox"/>	LAG1	1	ALL	Disable	Disable		
<input type="checkbox"/>	LAG2	1	ALL	Disable	Disable		
<input type="checkbox"/>	LAG3	1	ALL	Disable	Disable		
<input type="checkbox"/>	LAG4	1	ALL	Disable	Disable		
<input type="checkbox"/>	LAG5	1	ALL	Disable	Disable		
<input type="checkbox"/>	LAG6	1	ALL	Disable	Disable		
<input type="checkbox"/>	LAG7	1	ALL	Disable	Disable		
<input type="checkbox"/>	LAG8	1	ALL	Disable	Disable		

[Edit](#) [Cancel](#)

The following table describes the labels in this screen.

Table 73 Configuration &gt; VLAN &gt; VLAN &gt; Port

LABEL	DESCRIPTION
Port	
Port	Displays the port index number.

Table 73 Configuration &gt; VLAN &gt; VLAN &gt; Port (continued)

LABEL	DESCRIPTION
PVID	A PVID (Port VLAN ID) is a tag that adds to incoming untagged frames received on a port so that the frames are forwarded to the VLAN group that the tag defines.
Accept Frame Type	Specify the type of frames allowed on a port. Choices are <b>All</b> , <b>Tag Only</b> and <b>Untag Only</b> .
Ingress Check	If this check box is selected for a port, the Switch discards incoming frames for VLANs that do not include this port in its member set.
VLAN Trunk	Enable VLAN Trunking on ports connected to other switches or routers (but not ports directly connected to end users) to allow frames belonging to unknown VLAN groups to pass through the Switch.
Edit	Select this check box to configure the properties of a port. Click the <b>Edit</b> button change the properties of the port.
Cancel	Click <b>Cancel</b> to discard the changes.

## 20.2.4 The Port Edit Screen

Use this screen to configure port settings. Click **Configuration > VLAN > VLAN > Port > Edit** to open this screen.

Figure 111 Configuration &gt; VLAN &gt; VLAN &gt; Port &gt; Edit

The following table describes the labels in this screen.

Table 74 Configuration &gt; VLAN &gt; VLAN &gt; Port &gt; Edit

LABEL	DESCRIPTION
Port	
Port Select	Displays the list of port index numbers that are being configured.
PVID	Enter a number between 1 and 4094 as the port VLAN ID.
Accepted Type	Select <b>All</b> from the drop-down list box to accept all untagged or tagged frames on this port. This is the default setting.  Select <b>Tag Only</b> to accept only tagged frames on this port. All untagged frames will be dropped.  Select <b>Untag Only</b> to accept only untagged frames on this port. All tagged frames will be dropped.
Ingress Filtering	If this check box is selected for a port, the Switch discards incoming frames for VLANs that do not include this port in its member set.  Clear this check box to disable ingress filtering.

Table 74 Configuration &gt; VLAN &gt; VLAN &gt; Port &gt; Edit (continued)

LABEL	DESCRIPTION
VLAN Trunk	Enable VLAN Trunking on ports connected to other switches or routers (but not ports directly connected to end users) to allow frames belonging to unknown VLAN groups to pass through the Switch.
Apply	Click <b>Apply</b> to save the changes.
Cancel	Click <b>Cancel</b> to discard the changes.

## 20.2.5 The VLAN Port Screen

Port-based VLANs are VLANs where the packet forwarding decision is based on the destination MAC address and its associated port. Port-based VLANs require allowed outgoing ports to be defined for each port. Therefore, if you wish to allow two subscriber ports to talk to each other, for example, between conference rooms in a hotel, you must define the egress (an egress port is an outgoing port, that is, a port through which a data packet leaves) for both ports. Port-based VLANs are specific only to the Switch on which they were created.

Use this screen to view VLAN port settings. Click **Configuration > VLAN > VLAN > VLAN Port** to open this screen.

Figure 112 Configuration &gt; VLAN &gt; VLAN &gt; VLAN Port

VLAN Port		<a href="#">VLAN</a> <a href="#">Port</a> <a href="#">VLAN Port</a>	
VLAN ID	1		
Port	Membership		
*	Untagged		
1	<input type="radio"/> Forbidden <input type="radio"/> Excluded <input type="radio"/> Tagged <input checked="" type="radio"/> Untagged		
2	<input type="radio"/> Forbidden <input type="radio"/> Excluded <input type="radio"/> Tagged <input checked="" type="radio"/> Untagged		
3	<input type="radio"/> Forbidden <input type="radio"/> Excluded <input type="radio"/> Tagged <input checked="" type="radio"/> Untagged		
4	<input type="radio"/> Forbidden <input type="radio"/> Excluded <input type="radio"/> Tagged <input checked="" type="radio"/> Untagged		
5	<input type="radio"/> Forbidden <input type="radio"/> Excluded <input type="radio"/> Tagged <input checked="" type="radio"/> Untagged		
6	<input type="radio"/> Forbidden <input type="radio"/> Excluded <input type="radio"/> Tagged <input checked="" type="radio"/> Untagged		
7	<input type="radio"/> Forbidden <input type="radio"/> Excluded <input type="radio"/> Tagged <input checked="" type="radio"/> Untagged		
25	<input type="radio"/> Forbidden <input type="radio"/> Excluded <input type="radio"/> Tagged <input checked="" type="radio"/> Untagged		
26	<input type="radio"/> Forbidden <input type="radio"/> Excluded <input type="radio"/> Tagged <input checked="" type="radio"/> Untagged		
LAG1	<input type="radio"/> Forbidden <input type="radio"/> Excluded <input type="radio"/> Tagged <input checked="" type="radio"/> Untagged		
LAG2	<input type="radio"/> Forbidden <input type="radio"/> Excluded <input type="radio"/> Tagged <input checked="" type="radio"/> Untagged		
LAG3	<input type="radio"/> Forbidden <input type="radio"/> Excluded <input type="radio"/> Tagged <input checked="" type="radio"/> Untagged		
LAG4	<input type="radio"/> Forbidden <input type="radio"/> Excluded <input type="radio"/> Tagged <input checked="" type="radio"/> Untagged		
LAG5	<input type="radio"/> Forbidden <input type="radio"/> Excluded <input type="radio"/> Tagged <input checked="" type="radio"/> Untagged		
LAG6	<input type="radio"/> Forbidden <input type="radio"/> Excluded <input type="radio"/> Tagged <input checked="" type="radio"/> Untagged		
LAG7	<input type="radio"/> Forbidden <input type="radio"/> Excluded <input type="radio"/> Tagged <input checked="" type="radio"/> Untagged		
LAG8	<input type="radio"/> Forbidden <input type="radio"/> Excluded <input type="radio"/> Tagged <input checked="" type="radio"/> Untagged		
		<a href="#">Apply</a>	<a href="#">Cancel</a>

The following table describes the labels in this screen.

Table 75 Configuration > VLAN > VLAN > VLAN Port

LABEL	DESCRIPTION
VLAN Port	
VLAN ID	Select the ID of the VLAN you want to configure.
Port	Displays the port index value.
Membership	Select <b>Forbidden</b> if you want to prohibit the port from joining this VLAN group. Select <b>Excluded</b> to remove the port from the VLAN. Select <b>Tagged</b> to set the port TX tag status to tagged in the VLAN. Select <b>Untagged</b> to set the port TX tag status to untagged in the VLAN.
Apply	Click <b>Apply</b> to save the changes.
Cancel	Click <b>Cancel</b> to discard the changes.

## 20.3 Guest VLAN

When 802.1x port authentication is enabled on the Switch and its ports, clients that do not have the correct credentials are blocked from using the port(s). You can configure your Switch to have one VLAN that acts as a guest VLAN. If you enable the guest VLAN (102 in the example) on a port (2 in the example), the user (A in the example) that is not IEEE 802.1x capable or fails to enter the correct username and password can still access the port, but traffic from the user is forwarded to the guest VLAN. That is, unauthenticated users can have access to limited network resources in the same guest VLAN, such as the Internet. The rights granted to the Guest VLAN depends on how the network administrator configures switches or routers with the guest network feature.

Figure 113 Guest VLAN Example

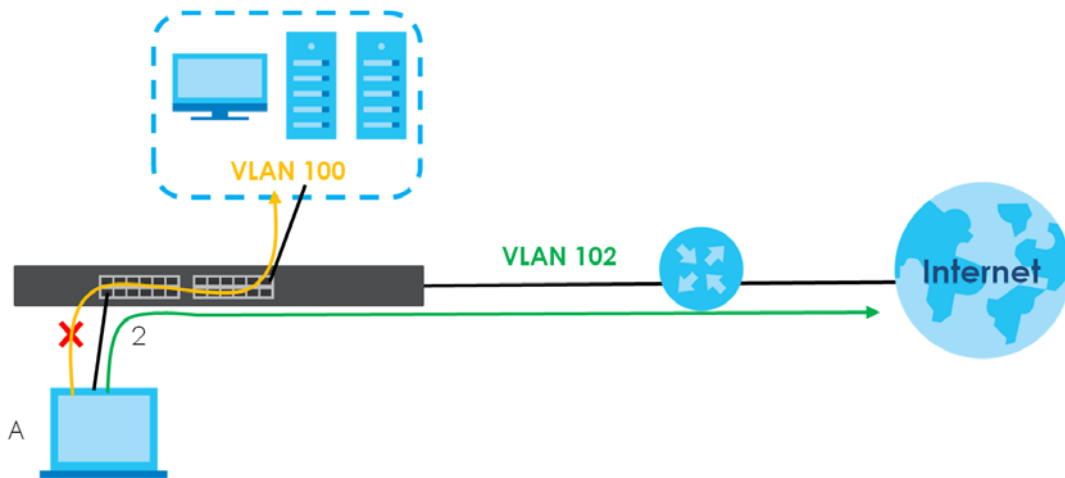

Use this screen to view and configure guest VLAN settings.

### 20.3.1 The Global Screen

Use this screen to configure the global Guest VLAN settings. Click **Configuration > VLAN > Guest VLAN > Global** to open this screen.

Figure 114 Configuration > VLAN > Guest VLAN > Global

Global		<a href="#">Global</a>	<a href="#">Port</a>
State	<input type="radio"/> Enable <input checked="" type="radio"/> Disable		
Guest VLAN ID	0		
<input type="button" value="Apply"/> <input type="button" value="Cancel"/>			

The following table describes the labels in this screen.

Table 76 Configuration > VLAN > Guest VLAN > Global

LABEL	DESCRIPTION
Global	
State	Select to enable the global Guest VLAN feature.
Guest VLAN ID	Enter the global guest VLAN ID.

Table 76 Configuration &gt; VLAN &gt; Guest VLAN &gt; Global (continued)

LABEL	DESCRIPTION
Apply	Click <b>Apply</b> to save the changes.
Cancel	Click <b>Cancel</b> to discard the changes.

## 20.3.2 The Port Screen

Use this screen to view the Guest VLAN port settings and select VLAN port(s) for configuration. Click **Configuration > VLAN > Guest VLAN > Port** to open this screen.

Figure 115 Configuration &gt; VLAN &gt; Guest VLAN &gt; Port

Port	State
<input type="checkbox"/> 1	Disable
<input type="checkbox"/> 2	Disable
<input type="checkbox"/> 3	Disable
<input type="checkbox"/> 4	Disable
<input type="checkbox"/> 5	Disable
<input type="checkbox"/> 6	Disable
<input type="checkbox"/> 7	Disable
<input type="checkbox"/> 21	Disable
<input type="checkbox"/> 22	Disable
<input type="checkbox"/> 23	Disable
<input type="checkbox"/> 24	Disable
<input type="checkbox"/> 25	Disable
<input type="checkbox"/> 26	Disable

**Edit** **Cancel**

The following table describes the labels in this screen.

Table 77 Configuration &gt; VLAN &gt; Guest VLAN &gt; Port

LABEL	DESCRIPTION
Port	
Port	Displays the port index number.
State	Display the state of the selected port.
Edit	Select this check box to configure the properties of a port. Click the <b>Edit</b> button change the properties of the port.
Cancel	Click <b>Cancel</b> to discard the changes.

## 20.3.3 The Port Edit Screen

Use this screen to configure the guest VLAN port EEE settings. Click **Configuration > VLAN > Guest VLAN > Port > Edit** to open this screen.

**Figure 116** Configuration > VLAN > Guest VLAN > Port > Edit

The following table describes the labels in this screen.

Table 78 Configuration &gt; VLAN &gt; Guest VLAN &gt; Port &gt; Edit

LABEL	DESCRIPTION
Port	
Port List	Displays the list of port index numbers that are being configured.
State	Enable/Disable the guest VLAN feature.
Apply	Click <b>Apply</b> to save the changes.
Cancel	Click <b>Cancel</b> to discard the changes.

## 20.4 Voice VLAN

The Voice VLAN feature enables voice traffic forwarding on the Voice VLAN, then the switch can classify and schedule network traffic. It is recommended that there be two VLANs on a port - one for voice, one for data.

Use this screen to view and configure voice VLAN settings.

### 20.4.1 The Global Screen

Use this screen to configure the global Voice VLAN settings. Click **Configuration > VLAN > Voice VLAN > Global** to open this screen.

**Figure 117** Configuration > VLAN > Voice VLAN > Global



The following table describes the labels in this screen.

Table 79 Configuration > VLAN > Voice VLAN > Global

LABEL	DESCRIPTION
Global	
State	Select <b>Enable</b> to activate the global voice VLAN feature.
Voice VLAN ID	Enter the global voice VLAN ID. It should be a unique VLAN ID in the system and cannot equal each port PVID. It is a conflict in configuration if the value equals management VID, MVR VID, PVID etc. The allowed range is 1 to 4094.
Cos/802.1p	Displays the 802.1p packet priority field.
Remark Cos/802.1p	Select to <b>Enable</b> the priority remark function for cos/802.1p.
Aging Time	Enter the voice VLAN secure learning aging time. The allowed range is 10 to 10000000 seconds. It is used when security mode or auto detect mode is enabled. In other cases, it will be based on hardware aging time. The actual aging time will be situated between the [age_time; 2 * age_time] interval.
Apply	Click <b>Apply</b> to save the changes.
Cancel	Click <b>Cancel</b> to discard the changes.

## 20.4.2 The OUI Screen

Use this screen to view the OUI settings. The maximum number of entries is 16. Modifying the OUI table will restart auto detection of OUI process. Click **Configuration > VLAN > Voice VLAN > OUI** to open this screen.

Figure 118 Configuration > VLAN > Voice VLAN > OUI

OUI		Global	OUI	Port
OUI Address	Description	Action		
00:E0:BB	3COM			
00:03:6B	Cisco			
00:E0:75	Veritel			
00:D0:1E	Pingtel			
00:01:E3	Siemens			
00:60:B9	NEC/Phillips			
00:0F:E2	H3C			
00:09:6E	Avaya			

[Add](#)

The following table describes the labels in this screen.

Table 80 Configuration > VLAN > Voice VLAN > OUI

LABEL	DESCRIPTION
OUI	
OUI Address	Displays an OUI address. A telephony OUI address is a globally unique identifier assigned to a vendor by IEEE. It must be 6 characters long and the input format is "xx-xx-xx" (x is a hexadecimal digit).
Description	Displays a description of the OUI address. Normally, it describes which vendor telephony device it belongs to. The allowed string length is 0 to 32.

Table 80 Configuration &gt; VLAN &gt; Voice VLAN &gt; OUI

LABEL	DESCRIPTION
Action	
Edit	Click <b>Edit</b> to make changes to the entry.
Delete	Click <b>Delete</b> to remove the entry.
Add	Click <b>Add</b> to create a new OUI entry.

### 20.4.3 The OUI Add/Edit Screen

Use this screen to add/edit an OUI address. Click **Configuration > VLAN > Voice VLAN > OUI > Add/Edit** to open this screen.

Figure 119 Configuration &gt; VLAN &gt; Voice VLAN &gt; OUI &gt; Add/Edit

The following table describes the labels in this screen.

Table 81 Configuration &gt; VLAN &gt; Voice VLAN &gt; OUI &gt; Add/Edit

LABEL	DESCRIPTION
Add/Edit OUI	
OUI Address	Enter an OUI address. A telephony OUI address is a globally unique identifier assigned to a vendor by IEEE. It must be 6 characters long and the input format is "xx-xx-xx" (x is a hexadecimal digit).
Description	Enter a description of the OUI address. Normally, it describes which vendor telephony device it belongs to. The allowed string length is 0 to 32.
Apply	Click <b>Apply</b> to save the changes.
Cancel	Click <b>Cancel</b> to discard the changes.

### 20.4.4 The Port Screen

Use this screen to view the Voice VLAN port settings and select a port for configuration. Click **Configuration > VLAN > Voice VLAN > Port** to open this screen.

Figure 120 Configuration &gt; VLAN &gt; Voice VLAN &gt; Port

Port	State
<input type="checkbox"/> 1	Disable
<input type="checkbox"/> 2	Disable
<input type="checkbox"/> 3	Disable
<input type="checkbox"/> 4	Disable
<input type="checkbox"/> 5	Disable
<input type="checkbox"/> 6	Disable
<input type="checkbox"/> 7	Disable
<input type="checkbox"/> 21	Disable
<input type="checkbox"/> 22	Disable
<input type="checkbox"/> 23	Disable
<input type="checkbox"/> 24	Disable
<input type="checkbox"/> 25	Disable
<input type="checkbox"/> 26	Disable

The following table describes the labels in this screen.

Table 82 Configuration &gt; VLAN &gt; Voice VLAN &gt; Port

LABEL	DESCRIPTION
Port	
Port	Displays the port index value.
State	Displays the Voice VLAN port security mode state. When the function is enabled, all non-telephonic MAC addresses in the Voice VLAN will be blocked for 10 seconds. Possible port modes are: <ul style="list-style-type: none"> <li>• <b>Enabled:</b> Enable Voice VLAN security mode operation.</li> <li>• <b>Disabled:</b> Disable Voice VLAN security mode operation.</li> </ul>
Edit	Select this check box to configure the properties of a port. Click the <b>Edit</b> button change the properties of the port.
Cancel	Click <b>Cancel</b> to discard the changes.

## 20.4.5 The Port Edit Screen

Use this screen to edit the port(s) security state. Click **Configuration > VLAN > Voice VLAN > Port > Edit** to open this screen.

Figure 121 Configuration &gt; VLAN &gt; Voice VLAN &gt; Port &gt; Edit

Port	
State	<input type="radio"/> Enable <input checked="" type="radio"/> Disable

The following table describes the labels in this screen.

Table 83 Configuration > VLAN > Voice VLAN > Port > Edit

LABEL	DESCRIPTION
Port	
Port	Displays the port(s) index value.
State	Select the Voice VLAN port security mode state. When the function is enabled, all non-telephonic MAC addresses in the Voice VLAN will be blocked for 10 seconds. Possible port modes are: <ul style="list-style-type: none"><li>• <b>Enabled:</b> Enable Voice VLAN security mode operation.</li><li>• <b>Disabled:</b> Disable Voice VLAN security mode operation.</li></ul>
Apply	Click <b>Apply</b> to save the changes.
Cancel	Click <b>Cancel</b> to discard the changes.

# CHAPTER 21

## Configuration: MAC Table

### 21.1 Overview

This section provides information for **MAC Table** in **Configuration**.

The **MAC Table** screen (a MAC table is also known as a filtering database) shows how frames are forwarded or filtered across the Switch's ports. When a device (which may belong to a VLAN group) sends a packet which is forwarded to a port on the Switch, the MAC address of the device is shown on the Switch's **MAC Table**. It also shows whether the MAC address is dynamic (learned by the Switch) or static (manually entered in the **Static MAC Forwarding** screen).

#### 21.1.1 What You Can Do in this Chapter

The **MAC Table** screen ([Section 21.2 on page 133](#)) displays Static MAC, Filtering MAC, and Dynamic MAC settings.

### 21.2 MAC Table

#### 21.2.1 The Static MAC Screen

Use this screen to view Static MAC addresses settings. Click **Configuration > MAC Table > Static MAC** to open this screen.

**Figure 122** Configuration > MAC Table > Static MAC

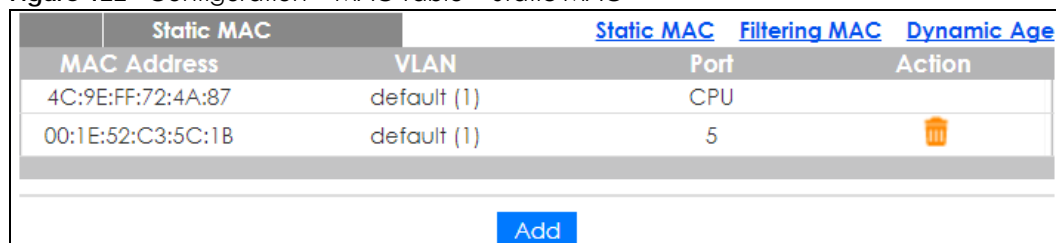

Static MAC		<a href="#">Static MAC</a>	<a href="#">Filtering MAC</a>	<a href="#">Dynamic Age</a>
MAC Address	VLAN	Port	Action	
4C:9E:FF:72:4A:87	default (1)	CPU		
00:1E:52:C3:5C:1B	default (1)	5		

[Add](#)

The following table describes the labels in this screen.

**Table 84** Configuration > MAC Table > Static MAC

LABEL	DESCRIPTION
Static MAC	
MAC Address	Displays the object MAC address from which this incoming frame came.
VLAN	Displays the VLAN group to which this frame belongs.
Port	Displays the port from which the above MAC address was learned.

Table 84 Configuration &gt; MAC Table &gt; Static MAC (continued)

LABEL	DESCRIPTION
Action	Click <b>Delete</b> to remove the MAC address.
Add	Click <b>Add</b> to create a new <b>Static MAC</b> entry.

## 21.2.2 The Static MAC Add Screen

Use this screen to add new Static MAC addresses. Click **Configuration > MAC Table > Static MAC > Add** to open this screen.

Figure 123 Configuration &gt; MAC Table &gt; Static MAC &gt; Add

The following table describes the labels in this screen.

Table 85 Configuration &gt; MAC Table &gt; Static MAC &gt; Add

LABEL	DESCRIPTION
Static MAC	
MAC Address	Enter the object MAC address.
VLAN	Select the VLAN group which to associate the MAC address.
Port	Select the port which to associate the above MAC address.
Apply	Click <b>Apply</b> to save the changes.
Cancel	Click <b>Cancel</b> to discard the changes.

## 21.2.3 The Filtering MAC Screen

Use this screen to view Filtering MAC addresses. Click **Configuration > MAC Table > Filtering MAC** to open this screen.

Figure 124 Configuration &gt; MAC Table &gt; Filtering MAC

The following table describes the labels in this screen.

Table 86 Configuration > MAC Table > Filtering MAC

LABEL	DESCRIPTION
Filtering MAC	
MAC Address	Displays the filtering object MAC address from which this incoming frame came.
VLAN	Displays the VLAN group to which this frame belongs.
Action	
Delete	Click <b>Delete</b> to remove the entry.
Add	Click <b>Add</b> to create a new <b>Filtering MAC</b> entry.

## 21.2.4 The Filtering MAC Add Screen

Use this screen to add new Filtering MAC addresses. Click **Configuration > MAC Table > Filtering MAC > Add** to open this screen.

Figure 125 Configuration > MAC Table > Filtering MAC > Add

The following table describes the labels in this screen.

Table 87 Configuration > MAC Table > Filtering MAC > Add

LABEL	DESCRIPTION
Add Filtering MAC	
MAC Address	Enter the MAC address of the device.
VLAN	Select the VLAN group to associate the filtering object MAC address.
Apply	Click <b>Apply</b> to save the changes.
Cancel	Click <b>Cancel</b> to discard the changes.

## 21.2.5 The Dynamic Age Screen

Use this screen to enter the Dynamic MAC Age. The dynamic MAC age is how long all dynamically learned MAC addresses remain in the MAC address table before they age out (and must be relearned). Click **Configuration > MAC Table > Dynamic Age** to open this screen.

Figure 126 Configuration > MAC Table > Dynamic Age

The following table describes the labels in this screen.

Table 88 Configuration > Dynamic Age

LABEL	DESCRIPTION
Dynamic MAC Age	
Aging Time	Enter the aging time of the MAC address. The value can be between 10 and 630 seconds.
Apply	Click <b>Apply</b> to save the changes.
Cancel	Click <b>Cancel</b> to discard the changes.



# CHAPTER 22

# Configuration: Link Aggregation

## 22.1 Overview

This section provides information for **Link Aggregation** in **Configuration**.

This chapter shows you how to logically aggregate physical links to form one logical, higher bandwidth link.

### 22.1.1 What You Can Do in this Chapter

The **Link Aggregation** screen ([Section 22.2 on page 137](#)) displays global, LAG management, LAG port, and LACP port settings.

## 22.2 Link Aggregation

Link aggregation (trunking) is the grouping of physical ports into one logical higher-capacity link. You may want to trunk ports if for example, it is cheaper to use multiple lower-speed links than to under-utilize a high-speed, but more costly, single-port link.

However, the more ports you aggregate then the fewer available ports you have. A trunk group is one logical link containing multiple ports.

The Switch supports both static and dynamic link aggregation.

**Note:** In a properly planned network, it is recommended to implement static link aggregation only. This ensures increased network stability and control over the trunk groups on your Switch.

### 22.2.1 The Global Screen

Use this screen to configure global Link Aggregation settings. Click **Configuration > Link Aggregation > Global** to open this screen.

Figure 127 Configuration &gt; Link Aggregation &gt; Global

Global		<a href="#">Global</a>	<a href="#">LAG Management</a>	<a href="#">LAG Port</a>	<a href="#">LACP Port</a>
LACP State	<input type="radio"/> Enable <input checked="" type="radio"/> Disable				
LACP System Priority	<input type="text" value="65535"/>	(1-65535)			
Load Balance Algorithm	<input type="radio"/> MAC Address <input checked="" type="radio"/> IP/MAC Address				
<input type="button" value="Apply"/> <input type="button" value="Cancel"/>					

The following table describes the labels in this screen.

Table 89 Configuration &gt; Link Aggregation &gt; Global

LABEL	DESCRIPTION
Global	
LACP State	Select <b>Enable</b> to activate the link aggregation control protocol.
LACP System Priority	LACP system priority is a number between 1 and 65,535. The switch with the lowest system priority (and lowest port number if system priority is the same) becomes the LACP "server". The LACP "server" controls the operation of LACP setup. Enter a number to set the priority of an active port using Link Aggregation Control Protocol (LACP). The smaller the number, the higher the priority level.
Load Balance Algorithm	Select the outgoing traffic distribution type. Packets from the same source and/or to the same destination are sent over the same link within the trunk. By default, the Switch uses the <b>IP/MAC Address</b> distribution type. If the Switch is behind a router, the packet's destination or source MAC address will be changed. In this case, set the Switch to distribute traffic based on its IP address to make sure port trunking can work properly.  Select <b>MAC Address</b> to distribute traffic based on a combination of the packet's source and destination MAC addresses.  Select <b>IP/MAC Address</b> to distribute traffic based on a combination of the packet's source and destination IP addresses.
Apply	Click <b>Apply</b> to save the changes.
Cancel	Click <b>Cancel</b> to discard the changes.

## 22.2.2 The LAG Management Screen

Use this screen to view LAG management settings. Click **Configuration > Link Aggregation > LAG Management** to open this screen.

Figure 128 Configuration &gt; Link Aggregation &gt; LAG Management

LAG Management		<a href="#">Global</a>	<a href="#">LAG Management</a>	<a href="#">LAG Port</a>	<a href="#">LACP Port</a>	
LAG	Name	Type	Link Status	Active Member	Standby Member	Action
<input type="button" value="Add"/>						

The following table describes the labels in this screen.

Table 90 Configuration &gt; Link Aggregation &gt; LAG Management

LABEL	DESCRIPTION
LAG Management	
LAG	Displays the link aggregation group (LAG), that is, one logical link containing multiple ports.

Table 90 Configuration &gt; Link Aggregation &gt; LAG Management (continued)

LABEL	DESCRIPTION
Name	Displays the name of the link aggregation group.
Type	This field displays how these ports were added to the trunk group. It displays: <b>Static</b> - if the ports are configured as static members of a trunk group. <b>LACP</b> - if the ports are configured to join a trunk group via LACP.
Link Status	Displays link status as either <b>Link up</b> or <b>Link down</b> .
Active Member	Displays if this member is an active member of a trunk.
Standby Member	Displays if this member is a standby member of a trunk.
Action	
Edit	Click <b>Edit</b> to make changes to the entry.
Delete	Click <b>Delete</b> to remove the entry.
Add	Click <b>Add</b> to create a new <b>LAG Management</b> entry.

## 22.2.3 The LAG Add Screen

Use this screen to add a LAG. Click **Configuration > Link Aggregation > LAG Management > Add** to open this screen.

Figure 129 Configuration &gt; Link Aggregation &gt; LAG Management &gt; Add

The following table describes the labels in this screen.

Table 91 Configuration &gt; Link Aggregation &gt; LAG Management &gt; Add

LABEL	DESCRIPTION
LAG Management	
LAG	Select the link aggregation group (LAG).
Name	Enter the name of this entry.
Type	Select <b>Static</b> or <b>LACP</b> .
Member Ports	Select the member ports to be part of the LAG.

Table 91 Configuration &gt; Link Aggregation &gt; LAG Management &gt; Add (continued)

LABEL	DESCRIPTION
Apply	Click <b>Apply</b> to save the changes.
Cancel	Click <b>Cancel</b> to discard the changes.

## 22.2.4 The LAG Port Screen

Use this screen to view LAG port settings. Click **Configuration > Link Aggregation > LAG Port** to open this screen.

Figure 130 Configuration &gt; Link Aggregation &gt; LAG Port

LAG Port		Global LAG Management LAG Port LACP Port						
<input type="checkbox"/>	LAG	Name	Port Type	State	Speed	Duplex	FlowCtrl State	FlowCtrl Status
<input type="checkbox"/>	LAG1			Enable	Auto	Auto	Disable	Disable
<input type="checkbox"/>	LAG2			Enable	Auto	Auto	Disable	Disable
<input type="checkbox"/>	LAG3			Enable	Auto	Auto	Disable	Disable
<input type="checkbox"/>	LAG4			Enable	Auto	Auto	Disable	Disable
<input type="checkbox"/>	LAG5			Enable	Auto	Auto	Disable	Disable
<input type="checkbox"/>	LAG6			Enable	Auto	Auto	Disable	Disable
<input type="checkbox"/>	LAG7			Enable	Auto	Auto	Disable	Disable
<input type="checkbox"/>	LAG8			Enable	Auto	Auto	Disable	Disable

[Edit](#) [Cancel](#)

The following table describes the labels in this screen.

Table 92 Configuration &gt; Link Aggregation &gt; LAG Port

LABEL	DESCRIPTION
LAG Port	
LAG	Displays the LAG index value.
Name	Displays the LAG name.
Port Type	Displays the port type.
State	Displays the state as <b>Enable/Disable</b> .
Speed	Displays the speed value as <b>Auto, Auto-10M, Auto-100M, Auto-1000M, Auto-10/100M, 10M, 100M, or 1000M</b> .
Duplex	Displays the duplex value as <b>Full, Half, or Auto</b> .
FlowCtrl State	Displays whether flow control is <b>Enable/Disable</b> .
FlowCtrl Status	Displays whether flow control is in use ( <b>Enable</b> ) or not ( <b>Disable</b> ).
Edit	Select this check box to configure the properties of a port. Click the <b>Edit</b> button change the properties of the port.
Cancel	Click <b>Cancel</b> to discard the changes.

## 22.2.5 The LAG Port Edit Screen

Use this screen to edit a LAG port. Click **Configuration > Link Aggregation > LAG Port > Edit** to open this screen.

Figure 131 Configuration &gt; Link Aggregation &gt; LAG Port &gt; Edit

LAG Port		<a href="#">Global</a>	<a href="#">LAG Management</a>	<a href="#">LAG Port</a>	<a href="#">LACP Port</a>
LAG					
State	<input checked="" type="radio"/> Enable <input type="radio"/> Disable				
Speed	Auto ▼				
Flow Control	<input type="radio"/> Enable <input checked="" type="radio"/> Disable				
<input type="button" value="Apply"/> <input type="button" value="Cancel"/>					

The following table describes the labels in this screen.

Table 93 Configuration &gt; Link Aggregation &gt; LAG Port &gt; Edit

LABEL	DESCRIPTION
LAG Port	
LAG	Displays the LAG index values.
State	Select the state to be <b>Enable</b> or <b>Disable</b> .
Speed	Displays the speed value as <b>Auto</b> , <b>10M</b> , <b>100M</b> , or <b>1000M</b> .
Flow Control	Select <b>Enable</b> to use the flow control feature.
Apply	Click <b>Apply</b> to save the changes.
Cancel	Click <b>Cancel</b> to discard the changes.

## 22.2.6 The LACP Port Screen

Use this screen to view LACP Port settings. Click **Configuration > Link Aggregation > LACP Port** to open this screen.

Figure 132 Configuration &gt; Link Aggregation &gt; LACP Port

LACP Port		<a href="#">Global</a>	<a href="#">LAG Management</a>	<a href="#">LAG Port</a>	<a href="#">LACP Port</a>
<input type="checkbox"/>	Port	Priority	Timer(sec)		
<input type="checkbox"/>	1	1	30		
<input type="checkbox"/>	2	1	30		
<input type="checkbox"/>	3	1	30		
<input type="checkbox"/>	4	1	30		
<input type="checkbox"/>	5	1	30		
<input type="checkbox"/>	6	1	30		
<input type="checkbox"/>	7	1	30		
<input type="checkbox"/>	8	1	30		
<input type="checkbox"/>	22	1	30		
<input type="checkbox"/>	23	1	30		
<input type="checkbox"/>	24	1	30		
<input type="checkbox"/>	25	1	30		
<input type="checkbox"/>	26	1	30		
<input type="button" value="Edit"/> <input type="button" value="Cancel"/>					

The following table describes the labels in this screen.

Table 94 Configuration > Link Aggregation > LACP Port

LABEL	DESCRIPTION
LACP Port	
Port	Displays the port index number.
Priority	Displays the priority value.
Timer (sec)	Displays the Timer value in seconds.  Timeout is the time interval between the individual port exchanges of LACP packets in order to check that the peer port in the trunk group is still up. If a port does not respond after three tries, then it is deemed to be "down" and is removed from the trunk. Set a short timeout (one second) for busy trunked links to ensure that disabled ports are removed from the trunk group as soon as possible.
Edit	Select this check box to configure the properties of a port. Click the <b>Edit</b> button change the properties of the port.
Cancel	Click <b>Cancel</b> to discard the changes.

## 22.2.7 The LACP Port Edit Screen

Use this screen to edit a LACP Port. Click **Configuration > Link Aggregation > LACP Port > Edit** to open this screen.

Figure 133 Configuration > Link Aggregation > LACP Port > Edit

The following table describes the labels in this screen.

Table 95 Configuration > Link Aggregation > LACP Port > Edit

LABEL	DESCRIPTION
LACP Port	
Port List	Displays the list of port index numbers to be configured.
Priority	Enter a value for the port priority. The number can be between 1 and 65,535.
Timer	Select a timer value of either 1 second or 30 seconds.
Apply	Click <b>Apply</b> to save the changes.
Cancel	Click <b>Cancel</b> to discard the changes.

# CHAPTER 23

## Configuration: Loop Guard

### 23.1 Overview

This section provides information for **Loop Guard** in **Configuration**.

This chapter shows you how to configure the Switch to guard against loops on the edge of your network.

### 23.2 Loop Guard

Loop guard allows you to configure the Switch to shut down a port if it detects that packets sent out on that port loop back to the Switch. While you can use Spanning Tree Protocol (STP) to prevent loops in the core of your network, STP cannot prevent loops that occur on the edge of your network.

#### 23.2.1 The Global Screen

Use this screen to configure the global Loop Guard. Click **Configuration > Loop Guard > Global** to open this screen.

**Figure 134** Configuration > Loop Guard > Global

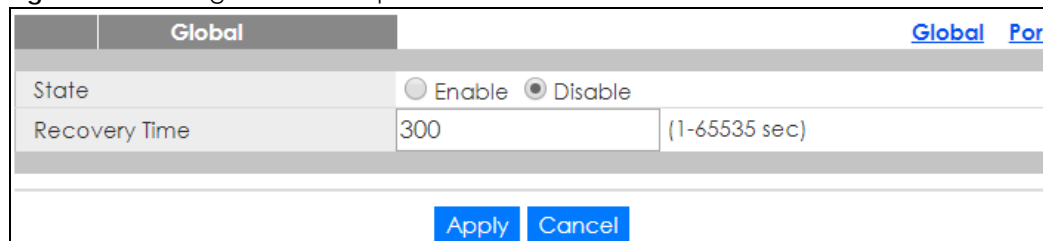

Global		Global	Port
State	<input type="radio"/> Enable <input checked="" type="radio"/> Disable		
Recovery Time	300	(1-65535 sec)	
<input type="button" value="Apply"/> <input type="button" value="Cancel"/>			

The following table describes the labels in this screen.

Table 96 Configuration > Loop Guard > Global

LABEL	DESCRIPTION
Global	
State	Select <b>Enable</b> to activate loop protection on this Switch.
Recovery Time	Enter the period (in seconds) for which a port will be kept disabled in the event of a loop is detected (and the port action shuts down the port).
Apply	Click <b>Apply</b> to save the changes.
Cancel	Click <b>Cancel</b> to discard the changes.

## 23.2.2 The Loop Guard Port

Use this screen to view the port's Loop Guard settings. Click **Configuration > Loop Guard > Port** to open this screen.

**Figure 135** Configuration > Loop Guard > Port

Port	State	Action
1	Disable	Shutdown Port
2	Disable	Shutdown Port
3	Disable	Shutdown Port
4	Disable	Shutdown Port
5	Disable	Shutdown Port
6	Disable	Shutdown Port
7	Disable	Shutdown Port
22	Disable	Shutdown Port
23	Disable	Shutdown Port
24	Disable	Shutdown Port
25	Disable	Shutdown Port
26	Disable	Shutdown Port

The following table describes the labels in this screen.

Table 97 Configuration > Loop Guard > Port

LABEL	DESCRIPTION
Port	
Port	Displays the port index number.
State	Displays whether the loop guard feature is <b>Enable</b> or <b>Disable</b> on the port.
Action	Displays the action to take by the Switch. The options are <b>Log</b> , <b>Shutdown Port</b> , and <b>Shutdown and Log</b> .
Edit	Select this check box to configure the properties of a port. Click the <b>Edit</b> button change the properties of the port.
Cancel	Click <b>Cancel</b> to discard the changes.

## 23.2.3 The Port Edit Screen

Use this screen to configure Loop Guard settings on a port. Click **Configuration > Loop Guard > Port > Edit** to open this screen.

**Figure 136** Configuration > Loop Guard > Port > Edit



The following table describes the labels in this screen.

Table 98 Configuration > Loop Guard > Port > Edit

LABEL	DESCRIPTION
Port	
Port List	Displays the list of port index numbers to be configured.
State	Select to enable or disable the loop guard feature on the port.
Action	Select to have the Switch shut down a port and/or generate a log message if it detects that packets sent out on that port loop back to the Switch.
Apply	Click <b>Apply</b> to save the changes.
Cancel	Click <b>Cancel</b> to discard the changes.

# CHAPTER 24

## Configuration: Mirror

### 24.1 Overview

This section provides information for **Mirror** in **Configuration**.

### 24.2 Mirror

Port mirroring allows you to copy a traffic flow to a monitor port (the port you copy the traffic to) in order that you can examine the traffic from the monitor port without interference.

The Switch supports local port mirroring.

#### 24.2.1 The Mirror Screen

Use this screen to configure Mirroring. Click **Configuration** > **Mirror** to open this screen.

**Figure 137** Configuration > Mirror

The screenshot shows the 'Mirror' configuration interface. At the top, there is a 'Mirror' tab and a 'Mirroring' section with radio buttons for 'Enable' and 'Disable', where 'Disable' is selected. Below this is a 'Monitor Port' dropdown menu set to '1'. The main area is divided into two sections: 'Egress' and 'Ingress'. Each section has two columns: 'Available' and 'Acting'. The 'Available' column contains a list of ports from 1 to 8. The 'Acting' column is currently empty. Blue arrow buttons (> and <) are positioned between the columns to allow moving ports. At the bottom of the screen, there are 'Apply' and 'Cancel' buttons.

The following table describes the labels in this screen.

Table 99 Configuration &gt; Mirror

LABEL	DESCRIPTION
Mirror	
Mirroring	Select <b>Enable</b> to activate port mirroring on the Switch or <b>Disable</b> to disable the feature.
Monitor Port	The monitor port is the port you copy the traffic to in order to examine it in more detail without interfering with the traffic flow on the original port(s). Type the port number of the monitor port.
Egress	Specify the ports to mirror outgoing traffic.
Available	Click < to move a severity type from the acting box to the available box. Click > to move a severity type to the acting box from the available box.
Acting	Click < to move a severity type from the acting box to the available box. Click > to move a severity type to the acting box from the available box.
>	Click > to move a severity type to the acting box from the available box.
<	Click < to move a severity type from the acting box to the available box.
Ingress	Specify the ports to mirror incoming traffic.
Available	Click < to move a severity type from the acting box to the available box. Click > to move a severity type to the acting box from the available box.
Acting	Click < to move a severity type from the acting box to the available box. Click > to move a severity type to the acting box from the available box.
>	Click > to move a severity type to the acting box from the available box.
<	Click < to move a severity type from the acting box to the available box.
Apply	Click <b>Apply</b> to save the changes.
Cancel	Click <b>Cancel</b> to discard the changes.

# CHAPTER 25

## Configuration: Time Range Group

### 25.1 Overview

You can set up one-time and recurring schedules for time-oriented features, such as PoE. The Switch supports one-time and recurring schedules. One-time schedules are effective only once, while recurring schedules usually repeat. Both types of schedules are based on the current date and time in the Switch.

#### 25.1.1 What You Can Do

The **Time Range Group** screen (Section 25.2.1 on page 148) displays or defines a time range (schedule) rule on the Switch.

### 25.2 Time Range Group

Use this screen to view or edit a time range rule on the Switch.

#### 25.2.1 The Time Range Group Screen

Use this screen to view the time range rules. Click **Configuration > Time Range Group** in the navigation panel to display the screen as shown.

**Figure 138** Configuration > Time Range Group

Index	Name	Type	Range	Action
1	Weekday	Periodic	Weekdays 08:00 to 17:00	
2	Weekend	Absolute	2017/08/26 08:00 to 2017/08/27 17:00 0	

[Add](#)

The following table describes the labels in this screen.

Table 100 Configuration > Time Range Group

LABEL	DESCRIPTION
Index	This field displays the index number of the rule.
Name	This field displays the descriptive name for this rule. This is for identification purpose only.

Table 100 Configuration &gt; Time Range Group (continued)

LABEL	DESCRIPTION
Type	This field displays the type of the rule.
Range	This field displays the time period(s) to which this rule applies.
Action	Click <b>Edit</b> to change the rule settings. Click <b>Delete</b> to remove the rule.
Add	Click <b>Add</b> to create a new time range rule.

## 25.2.2 The Time Range Add Screen

Use this screen to add a new time range (schedule) rule. Click **Configuration > Time Range Group > Add** in the navigation panel to display the screen as shown.

Figure 139 Configuration &gt; Time Range Group &gt; Add

The screenshot shows the 'Time Range Group' configuration screen. It includes a title bar, a 'Name' input field, a 'Type' section with radio buttons for 'Absolute' and 'Periodic', and two main sections: 'Absolute' and 'Periodic'. The 'Absolute' section has 'Start' and 'End' fields, each with dropdowns for year, month, day, hour, and minute. The 'Periodic' section has radio buttons for 'Sun', 'Mon', 'Tue', 'Wed', 'Thu', 'Fri', 'Sat', 'Sun', 'Weekday', and 'Weekend', and a 'Daily' checkbox. Below these are time range dropdowns. At the bottom, there are 'Apply' and 'Cancel' buttons.

The following table describes the labels in this screen.

Table 101 Configuration &gt; Time Range Group &gt; Add

LABEL	DESCRIPTION
Name	Enter a descriptive name for this rule for identifying purposes.
Type	Select <b>Absolute</b> to create a one-time schedule. One-time schedules begin on a specific start date and time and end on a specific stop date and time. One-time schedules are useful for long holidays and vacation periods.  Alternatively, select <b>Periodic</b> to create a recurring schedule. Recurring schedules begin at a specific start time and end at a specific stop time on selected days of the week (Sunday, Monday, Tuesday, Wednesday, Thursday, Friday, and Saturday). Recurring schedules are useful for defining the workday and off-work hours.
Absolute	This section is available only when you set <b>Type</b> to <b>Absolute</b> .
Start	Specify the year, month, day, hour and minute when the schedule begins.
End	Specify the year, month, day, hour and minute when the schedule ends.

Table 101 Configuration &gt; Time Range Group &gt; Add (continued)

LABEL	DESCRIPTION
Periodic	This section is available only when you set <b>Type</b> to <b>Periodic</b> .  Select the first option if you want to define a recurring schedule for a consecutive time period. You then select the day of the week, hour and minute when the schedule begins and ends respectively.  Select the second option if you want to define a recurring schedule for multiple non-consecutive time periods. You need to select each day of the week the recurring schedule is effective. You also need to specify the hour and minute when the schedule begins and ends each day. The schedule begins and ends in the same day.
Apply	Click <b>Apply</b> to save your changes to the Switch's run-time memory. The Switch loses these changes if it is turned off or loses power, so use the <b>Save</b> link on the top navigation panel to save your changes to the non-volatile memory when you are done configuring.
Cancel	Click <b>Cancel</b> to reset the fields to your previous configuration.

## 25.2.3 The Time Range Edit Screen

Use this screen to modify an existing time range rule. Click **Configuration > Time Range Group > Edit** in the navigation panel to display the screens as shown.

### 25.2.3.1 Edit an Absolute Time Range Rule

Click the **Edit** button in the **Action** field to modify an absolute time range rule.

Figure 140 Configuration &gt; Time Range Group &gt; Edit (Absolute)

Time Range Group	
Name	Weekend
Type	Absolute
Range	Start 2017 ▾ 08 ▾ 26 ▾ 08 ▾ : 00 ▾
	End 2017 ▾ 08 ▾ 27 ▾ 17 ▾ : 00 ▾
<input type="button" value="Apply"/> <input type="button" value="Cancel"/>	

The following table describes the labels in this screen.



Table 102 Configuration &gt; Time Range Group &gt; Edit (Absolute)

LABEL	DESCRIPTION
Name	This field displays the descriptive name for this rule. This is for identification purpose only.
Type	This field displays the type of the rule.
Range	Specify the year, month, day, hour and minute when the schedule begins and ends.
Apply	Click <b>Apply</b> to save your changes to the Switch's run-time memory. The Switch loses these changes if it is turned off or loses power, so use the <b>Save</b> link on the top navigation panel to save your changes to the non-volatile memory when you are done configuring.
Cancel	Click <b>Cancel</b> to reset the fields to your previous configuration.

### 25.2.3.2 Edit a Periodic Time Range Rule

Click the **Edit** button in the **Action** field to modify a periodic time range rule. A screen will appear showing the name, type, and range of this rule. Click the **Edit** button again to modify it, or you can click the **Add** button to create a new range under a periodic time range rule.

**Figure 141** Configuration > Time Range Group > Edit (Periodic)

Time Range Group		
Name	Weekday	
Type	Periodic	
Index	Range	Action
1	Weekdays 08:00 to 17:00	 
<a href="#">Add</a>		

The following table describes the labels in this screen.

**Table 103** Configuration > Time Range Group > Edit (Periodic)

LABEL	DESCRIPTION
Time Range Group	
Name	This field displays the descriptive name for this rule. This is for identification purpose only.
Type	This field displays the type of the rule.
Index	This field displays the index number of the rule.
Range	This field displays the time period(s) to which this rule applies.
Action	Click <b>Edit</b> to change the rule settings. Click <b>Delete</b> to remove the rule.
Add	Click <b>Add</b> to create a new range.

**Figure 142** Configuration > Time Range Group > Edit (Periodic) > Edit

Time Range Group	
Name	Weekday
Type	Periodic
Range	<input type="radio"/> Sun 00 : 00 to Sun 00 : 00 <input checked="" type="radio"/> <input type="checkbox"/> Mon <input type="checkbox"/> Tue <input type="checkbox"/> Wed <input type="checkbox"/> Thu <input type="checkbox"/> Fri <input type="checkbox"/> Sat <input type="checkbox"/> Sun <input checked="" type="checkbox"/> Weekday <input type="checkbox"/> Weekend <input type="checkbox"/> Daily 08 : 00 to 17 : 00
<a href="#">Apply</a> <a href="#">Cancel</a>	

The following table describes the labels in this screen.

**Table 104** Configuration > Time Range Group > Edit (Periodic) > Add

LABEL	DESCRIPTION
Time Range Group	
Name	Enter a descriptive name for this rule for identifying purposes.
Type	This field displays the type of the rule.

Table 104 Configuration &gt; Time Range Group &gt; Edit (Periodic) &gt; Add (continued)

LABEL	DESCRIPTION
Range	<p>Select the first option if you want to define a recurring schedule for a consecutive time period. You then select the day of the week, hour and minute when the schedule begins and ends respectively.</p> <p>Select the second option if you want to define a recurring schedule for multiple non-consecutive time periods. You need to select each day of the week the recurring schedule is effective. You also need to specify the hour and minute when the schedule begins and ends each day. The schedule begins and ends in the same day.</p>
Apply	Click <b>Apply</b> to save your changes to the Switch's run-time memory. The Switch loses these changes if it is turned off or loses power, so use the <b>Save</b> link on the top navigation panel to save your changes to the non-volatile memory when you are done configuring.
Cancel	Click <b>Cancel</b> to reset the fields to your previous configuration.



# CHAPTER 26

## Configuration: Multicast

### 26.1 Overview

This section provides information for **Multicast** in **Configuration**.

Traditionally, IP packets are transmitted in one of either two ways - Unicast (1 sender to 1 recipient) or Broadcast (1 sender to everybody on the network). Multicast delivers IP packets to just a group of hosts on the network.

### 26.2 IGMP

IGMP (Internet Group Management Protocol) is a network-layer protocol used to establish membership in an IPv4 multicast group - it is not used to carry user data. Refer to RFC 1112, RFC 2236 and RFC 3376 for information on IGMP versions 1, 2 and 3 respectively.

#### 26.2.1 The Global Screen

Use this screen to view the **IGMP Global** settings. Click **Configuration > Multicast > IGMP > Global** to open this screen.

**Figure 143** Configuration > Multicast > IGMP > Global

Global		<a href="#">Global</a>	<a href="#">VLAN</a>	<a href="#">Router Port</a>	<a href="#">Profile</a>	<a href="#">Throttling</a>
Snooping State	<input type="radio"/> Enable	<input checked="" type="radio"/> Disable				
Snooping Version	<input checked="" type="radio"/> v2	<input type="radio"/> v3				
Unknown Multicast Action	<input checked="" type="radio"/> Flood	<input type="radio"/> Drop				<input type="radio"/> Router Port
<input type="button" value="Apply"/> <input type="button" value="Cancel"/>						

The following table describes the labels in this screen.

Table 105 Configuration > Multicast > IGMP > Global

LABEL	DESCRIPTION
Global	
Snooping State	Select <b>Enable</b> to turn on IGMP packet snooping or <b>Disable</b> to turn snooping off.
Snooping Version	Select <b>v2</b> or <b>v3</b> depending on the snooping version you require.

Table 105 Configuration &gt; Multicast &gt; IGMP (continued)&gt; Global

LABEL	DESCRIPTION
Unknown Multicast Action	Select to send the IPv4 unknown multicast frame to the router port. The following options are available: <ul style="list-style-type: none"> <li>• <b>Flood</b> - select to send the frame(s) to all ports.</li> <li>• <b>Drop</b> - select to discard the frame(s).</li> <li>• <b>Router Port</b> - select to send the frame to router port.</li> </ul>
Apply	Click <b>Apply</b> to save the changes.
Cancel	Click <b>Cancel</b> to discard the changes.

## 26.2.2 The VLAN Screen

Use this screen to view the **IGMP VLAN** settings. Click **Configuration > Multicast > IGMP > VLAN** to open this screen.

Figure 144 Configuration &gt; Multicast &gt; IGMP &gt; VLAN

IGMP Vlan										
VLAN ID	State	Router Ports Auto Learn	Query Retry	Interval	Max. Response Interval	Last Member Query Count	Interval	State	Querier Version	
1	Disable	Enable	2	125	10	2	1	Disable	---	
										Total Entries: 1

The following table describes the labels in this screen.

Table 106 Configuration &gt; Multicast &gt; IGMP &gt; VLAN

LABEL	DESCRIPTION
IGMP Vlan	
VLAN ID	Displays the ID of a static VLAN; the valid range is between 1 and 4094.
State	Display the status of the VLAN as enabled or disabled.
Router Ports Auto Learn	Displays the Switch learn multicast router port member status of any VLANs as enabled or disabled.
Query	
Retry	Displays the number of query retry times.
Interval	Displays the amount of time (in seconds) between general query messages sent by the router connected to the upstream port.
Max. Response Interval (sec)	Displays the amount of time (in seconds) the router connected to the upstream port waits for a response to an IGMP general query message.
Last Member Query	
Count	Displays the number of queries.
Interval	Displays the amount of time (in milliseconds) between the IGMP group-specific queries sent by an upstream port when an IGMP Done message is received.
Querier	
State	Displays the Switch current VLAN querier entry as <b>Enable</b> or <b>Disable</b> .
Version	Displays the Switch current VLAN querier entry version.
Edit	Click <b>Edit</b> to change the properties of the IGMP VLAN entry.

## 26.2.3 The Edit IGMP Screen

Use this screen to configure the **IGMP VLAN** settings. Click **Configuration > Multicast > IGMP > VLAN > Edit** to open this screen.

**Figure 145** Configuration > Multicast > IGMP > VLAN > Edit

IGMP Edit		<a href="#">Global</a>	<a href="#">VLAN</a>	<a href="#">Router Port</a>	<a href="#">Profile</a>	<a href="#">Throttling</a>
VLAN List						
IGMP State	<input type="radio"/> Enable <input checked="" type="radio"/> Disable					
Router Ports Auto Learn	<input checked="" type="radio"/> Enable <input type="radio"/> Disable					
Query Retry	2	(1-7)				
Query Interval	125	(30-18000)				
Query Max. Response Interval	10	(5-20)				
Last Member Query Counter	2	(1-7)				
Last Member Query Interval	1	(1-25)				
IGMP Querier State	<input type="radio"/> Enable <input checked="" type="radio"/> Disable					
IGMP Querier Version	<input checked="" type="radio"/> v2 <input type="radio"/> v3					
<input type="button" value="Apply"/> <input type="button" value="Cancel"/>						

The following table describes the labels in this screen.

Table 107 Configuration > Multicast > IGMP > VLAN > Edit

LABEL	DESCRIPTION
IGMP Edit	
VLAN List	Enter the ID of a static VLAN; the valid range is between 1 and 4094.
IGMP State	Select the status of the VLAN to <b>Enable</b> or <b>Disable</b> the function.
Router Ports Auto Learn	Select <b>Enabled</b> to have the Switch learn multicast router membership information of any VLANs automatically.
Query Retry	Enter the number of query retry times. The value can be between 1 and 7.
Query Interval	Enter the amount of time (in seconds) between general query messages sent by the router connected to the upstream port. The value can be between 30 and 18000.
Query Max. Response Interval	Enter the amount of time (in seconds) the router connected to the upstream port waits for a response to an IGMP general query message.
Last Member Query Count	Enter the number of queries.
Last Member Query Interval	Enter the amount of time (in seconds) between the IGMP group-specific queries sent by an upstream port when an IGMP Done message is received.
IGMP Querier State	Select the IGMP querier status to <b>Enable</b> or <b>Disable</b> the function.
IGMP Querier Version	Select the IGMP Querier version to <b>v2</b> or <b>v3</b> .
Apply	Click <b>Apply</b> to save the changes.
Cancel	Click <b>Cancel</b> to discard the changes.

## 26.2.4 The Router Port Screen

Use this screen to view the **Router Port** settings. Click **Configuration > Multicast > IGMP > Router Port** to open this screen.

**Figure 146** Configuration > Multicast > IGMP > Router Port

Router Port		Global	VLAN	Router Port	Profile	Throttling
VLAN ID	Static Router Ports	Forbidden Router Ports		Action		
Add						

The following table describes the labels in this screen.

Table 108 Configuration > Multicast > IGMP > Router Port

LABEL	DESCRIPTION
Router Port	
VLAN ID	Displays the ID of a static VLAN; the valid range is between 1 and 4094.
Static Router Ports	Displays the ports that are defined as static router ports.
Forbidden Router Ports	Displays the ports that are defined as forbidden router ports.
Action	
Edit	Click <b>Edit</b> to make changes to the entry.
Delete	Click <b>Delete</b> to remove the entry.
Add	Click <b>Add</b> to create a new <b>Router Port</b> entry.

## 26.2.5 The Add/Edit Router Port Screen

Use this screen to configure the **Router Port** settings. Click **Configuration > Multicast > IGMP > Router Port > Add/Edit** to open this screen.

**Figure 147** Configuration > Multicast > IGMP > Router Port > Add/Edit

The following table describes the labels in this screen.

**Table 109** Configuration > Multicast > IGMP > Router Port > Add/Modify

LABEL	DESCRIPTION
IGMP Router Edit	
VLAN List	Enter the static VLAN IDs (valid range for each ID value is between 1 and 4094).
Static Router Ports Selects	Select the port(s) to be static router ports.
Forbidden Router Ports Selects	Select the port(s) to be forbidden router ports.
Apply	Click <b>Apply</b> to save the changes.
Cancel	Click <b>Cancel</b> to discard the changes.

## 26.2.6 The Profile Screen

Use this screen to view the **IGMP Profile** settings. Click **Configuration > Multicast > IGMP > Profile** to open this screen.

**Figure 148** Configuration > Multicast > IGMP > Profile

The following table describes the labels in this screen.

Table 110 Configuration > Multicast > IGMP > Profile

LABEL	DESCRIPTION
IGMP Profile	
Profile	Displays the <b>Profile</b> index number.
Group From	Displays the profile start group IP address.
Group To	Displays the profile end group IP address.
Match Action	Displays the action of the profile as <b>Permit</b> or <b>Deny</b> .
Action	
Edit	Click <b>Edit</b> to make changes to the entry.
Delete	Click <b>Delete</b> to remove the entry.
Add	Click <b>Add</b> to create a new <b>IGMP Profile</b> entry.

## 26.2.7 The Add/Edit Profile Screen

Use this screen to configure the **IGMP Profile** settings. Click **Configuration > Multicast > IGMP > Profile > Add/Edit** to open this screen.

Figure 149 Configuration > Multicast > IGMP > Profile > Add/Edit

The following table describes the labels in this screen.

Table 111 Configuration > Multicast > IGMP > Profile > Add/Edit

LABEL	DESCRIPTION
IGMP Profile	
Profile	Enter the <b>Profile</b> index number.
Group From	Enter the profile start group IP address.
Group To	Enter the profile end group IP address.
Match Action	Select the action of the profile as to be <b>Permit</b> or <b>Deny</b> .
Apply	Click <b>Apply</b> to save the changes.
Cancel	Click <b>Cancel</b> to discard the changes.

## 26.2.8 The Throttling Screen

Use this screen to view the **Throttling** settings. Click **Configuration > Multicast > IGMP > Throttling** to open this screen.

Figure 150 Configuration &gt; Multicast &gt; IGMP &gt; Throttling

IGMP Port Throttling		Global	VLAN	Router Port	Profile	Throttling
<input type="checkbox"/>	Port	Max. Groups	Exceed Group Number	Action	Filter Profile ID	
<input type="checkbox"/>	1	256	Deny	Deny	None	
<input type="checkbox"/>	2	256	Deny	Deny	None	
<input type="checkbox"/>	3	256	Deny	Deny	None	
<input type="checkbox"/>	4	256	Deny	Deny	None	
<input type="checkbox"/>	5	256	Deny	Deny	None	
<input type="checkbox"/>	6	256	Deny	Deny	None	
<input type="checkbox"/>	7	256	Deny	Deny	None	
<input type="checkbox"/>	23	256	Deny	Deny	None	
<input type="checkbox"/>	24	256	Deny	Deny	None	
<input type="checkbox"/>	25	256	Deny	Deny	None	
<input type="checkbox"/>	26	256	Deny	Deny	None	
<input type="checkbox"/>	LAG1	256	Deny	Deny	None	
<input type="checkbox"/>	LAG2	256	Deny	Deny	None	
<input type="checkbox"/>	LAG3	256	Deny	Deny	None	
<input type="checkbox"/>	LAG4	256	Deny	Deny	None	
<input type="checkbox"/>	LAG5	256	Deny	Deny	None	
<input type="checkbox"/>	LAG6	256	Deny	Deny	None	
<input type="checkbox"/>	LAG7	256	Deny	Deny	None	
<input type="checkbox"/>	LAG8	256	Deny	Deny	None	

The following table describes the labels in this screen.

Table 112 Configuration &gt; Multicast &gt; IGMP &gt; Throttling

LABEL	DESCRIPTION
IGMP Port Throttling	
Port	Displays the port index value.
Max. Groups	Displays the maximum number of groups.
Exceed Group Number Action	Displays the action taken by the groups as <b>Permit</b> or <b>Deny</b> .
Filter Profile ID	Displays the throttling filter profile ID.
Edit	Select this check box to configure the properties of a port. Click the <b>Edit</b> button change the properties of the port.
Cancel	Click <b>Cancel</b> to discard the changes.

## 26.2.9 The Edit Throttling Screen

Use this screen to configure the **Throttling** settings. Click **Configuration > Multicast > IGMP > Throttling > Edit** to open this screen.

Figure 151 Configuration &gt; Multicast &gt; IGMP &gt; Throttling &gt; Edit

IGMP Port Throttling		Global	VLAN	Router Port	Profile	Throttling
Port List						
Max. Groups	256	(0-256)				
Exceed Group Number Action	<input checked="" type="radio"/> Deny <input type="radio"/> Replace					
Filter Profile ID	None ▼					
<input type="button" value="Apply"/> <input type="button" value="Cancel"/>						

The following table describes the labels in this screen.

Table 113 Configuration &gt; Multicast &gt; IGMP &gt; Throttling &gt; Edit

LABEL	DESCRIPTION
IGMP Port Throttling	
Port List	Enter the port index value(s).
Max. Groups	Enter the maximum number of groups. Enter a value between 0 and 256.
Exceed Group Number Action	Select the action taken by the groups to be <b>Deny</b> or <b>Replace</b> .
Filter Profile ID	Select the throttling filter profile ID from the dropdown list.
Apply	Click <b>Apply</b> to save the changes.
Cancel	Click <b>Cancel</b> to discard the changes.



# CHAPTER 27

## Configuration: Spanning Tree

### 27.1 Overview

This section provides information for **Spanning Tree** in **Configuration**.

The Switch supports Spanning Tree Protocol (STP), Rapid Spanning Tree Protocol (RSTP) and Multiple Spanning Tree Protocol (MSTP) as defined in the following standards.

- IEEE 802.1D Spanning Tree Protocol
- IEEE 802.1w Rapid Spanning Tree Protocol
- IEEE 802.1s Multiple Spanning Tree Protocol

The Switch also allows you to set up multiple STP configurations (or trees). Ports can then be assigned to the trees.

### 27.2 Spanning Tree

(R)STP detects and breaks network loops and provides backup links between switches, bridges or routers. It allows a Switch to interact with other (R)STP-compliant switches in your network to ensure that only one path exists between any two stations on the network.

#### 27.2.1 The Global Screen

Use this screen to view the **Global** settings. Click **Configuration > Spanning Tree > Global** to open this screen.

**Figure 152** Configuration > Spanning Tree > Global

Global	Global	STP Port	CIST	CIST Port	MST	MST Port
State	<input type="radio"/> Enable <input checked="" type="radio"/> Disable					
BPDU Forward	<input checked="" type="radio"/> Flooding <input type="radio"/> Filtering					
PathCost Method	<input type="radio"/> Short <input checked="" type="radio"/> Long					
Version	RSTP ▼					
Configuration Name	4C:9E:FF:72:4A:87		(Max.32 charactor)			
Configuration Revision	0		(0 - 65535)			
<input type="button" value="Apply"/> <input type="button" value="Cancel"/>						

The following table describes the labels in this screen.

Table 114 Configuration &gt; Spanning Tree &gt; Global

LABEL	DESCRIPTION
Global	
State	Select to <b>Enable</b> or <b>Disable</b> the Spanning-Tree function.
BPDU Forward	Select the bridge protocol data units forward (BPDU) option to be <b>Flooding</b> or <b>Filtering</b> .
Path Cost Method	Select <b>Short</b> or <b>Long</b> as a <b>Path Cost</b> method.  Path cost is the cost of transmitting a frame on to a LAN through that port. It is recommended that you assign this value according to the speed of the bridge. The slower the media, the higher the cost - see Table 40 on page 112 for more information.
Version	Select the type of spanning tree protocol to use. The following options are available: <ul style="list-style-type: none"> <li>• STP</li> <li>• RSTP</li> <li>• MSTP</li> </ul>
Configuration Name	Enter the name of the configuration in hexadecimal. The maximum number characters is 32.
Configuration Revision	Enter the revision number of configuration. The number can be between 0 and 65535.
Apply	Click <b>Apply</b> to save the changes.
Cancel	Click <b>Cancel</b> to discard the changes.

## 27.2.2 The STP Port Screen

Use this screen to view the **STP Port** settings. Click **Configuration > Spanning Tree > STP Port** to open this screen.

Figure 153 Configuration &gt; Spanning Tree &gt; STP Port

STP Port				Global	STP Port	CIST	CIST Port	MST	MST Port
<input type="checkbox"/>	Port	State	External Cost	Edge Port	BPDU Filter	P2P MAC			
<input type="checkbox"/>	1	Enable	0	Yes	No	Yes			
<input type="checkbox"/>	2	Enable	0	Yes	No	Yes			
<input type="checkbox"/>	3	Enable	0	Yes	No	Yes			
<input type="checkbox"/>	4	Enable	0	Yes	No	Yes			
<input type="checkbox"/>	5	Enable	0	Yes	No	Yes			
<input type="checkbox"/>	6	Enable	0	Yes	No	Yes			
<input type="checkbox"/>	7	Enable	0	Yes	No	Yes			
<input type="checkbox"/>	8	Enable	0	Yes	No	Yes			
<input type="checkbox"/>	9	Enable	0	Yes	No	Yes			
<input type="checkbox"/>	10	Enable	0	Yes	No	Yes			
<input type="checkbox"/>	11	Enable	0	Yes	No	Yes			
<input type="checkbox"/>	12	Enable	0	Yes	No	Yes			
<input type="checkbox"/>	13	Enable	0	Yes	No	Yes			
<input type="checkbox"/>	14	Enable	0	Yes	No	Yes			
<input type="checkbox"/>	15	Enable	0	Yes	No	Yes			
<input type="checkbox"/>	16	Enable	0	Yes	No	Yes			
<input type="checkbox"/>	17	Enable	0	Yes	No	Yes			
<input type="checkbox"/>	18	Enable	0	Yes	No	Yes			
<input type="checkbox"/>	19	Enable	0	Yes	No	Yes			
<input type="checkbox"/>	20	Enable	0	Yes	No	Yes			
<input type="checkbox"/>	21	Enable	0	Yes	No	Yes			
<input type="checkbox"/>	22	Enable	0	Yes	No	Yes			
<input type="checkbox"/>	23	Enable	0	Yes	No	Yes			
<input type="checkbox"/>	24	Enable	0	Yes	No	Yes			
<input type="checkbox"/>	25	Enable	0	Yes	No	Yes			
<input type="checkbox"/>	26	Enable	0	Yes	No	Yes			
<input type="checkbox"/>	LAG1	Enable	0	Yes	No	Yes			
<input type="checkbox"/>	LAG2	Enable	0	Yes	No	Yes			
<input type="checkbox"/>	LAG3	Enable	0	Yes	No	Yes			
<input type="checkbox"/>	LAG4	Enable	0	Yes	No	Yes			
<input type="checkbox"/>	LAG5	Enable	0	Yes	No	Yes			
<input type="checkbox"/>	LAG6	Enable	0	Yes	No	Yes			
<input type="checkbox"/>	LAG7	Enable	0	Yes	No	Yes			
<input type="checkbox"/>	LAG8	Enable	0	Yes	No	Yes			

The following table describes the labels in this screen.

Table 115 Configuration &gt; Spanning Tree &gt; STP Port

LABEL	DESCRIPTION
STP Port	
Port	Displays the index number of the STP port.
State	Display the status of the STP port as enabled or disabled.
External Cost	Displays the external path cost.
Edge Port	Displays the edge port status as <b>Yes</b> or <b>No</b> .
BPDU Filter	Displays the BPDU filter status as <b>Yes</b> or <b>No</b> .
P2P MAC	Displays the P2P MAC status as <b>Yes</b> or <b>No</b> .
Edit	Select this check box to configure the properties of a port. Click the <b>Edit</b> button change the properties of the port.
Cancel	Click <b>Cancel</b> to discard the changes.

### 27.2.3 The STP Port Edit Screen

Use this screen to configure the **STP Port Edit** settings. Click **Configuration > Spanning Tree > STP Port > Edit** to open this screen.

Figure 154 Configuration &gt; Spanning Tree &gt; STP Port &gt; Edit

The following table describes the labels in this screen.

Table 116 Configuration &gt; Spanning Tree &gt; STP Port &gt; Edit

LABEL	DESCRIPTION
STP Port	
Port List	Enter the index number of the STP port(s).
External Path Cost (0=Auto)	Enter the external path cost. Enter 0 for Auto.
State	Select the state of the STP port as enabled or disabled.
Edge Port	Select this check box to configure a port as an edge port when it is directly attached to a computer. An edge port changes its initial STP port state from blocking state to forwarding state immediately without going through listening and learning states right after the port is configured as an edge port or when its link status changes.  Note: An edge port becomes a non-edge port as soon as it receives a Bridge Protocol Data Unit (BPDU).
BPDU Filter	Select <b>Yes</b> to activate BPDU filter or <b>No</b> to deactivate it.

Table 116 Configuration &gt; Spanning Tree &gt; STP Port &gt; Edit (continued)

LABEL	DESCRIPTION
P2P MAC	Select <b>Yes</b> to activate P2P MAC or <b>No</b> to deactivate it.
Migrate	Select <b>Yes</b> to activate Migrate or <b>No</b> to deactivate it.
Apply	Click <b>Apply</b> to save the changes.
Cancel	Click <b>Cancel</b> to discard the changes.

## 27.2.4 The CIST Screen

Use this screen to view the CIST settings. Click **Configuration > Spanning Tree > CIST** to open this screen.

Figure 155 Configuration &gt; Spanning Tree &gt; CIST

CIST Instance		<a href="#">Global</a>	<a href="#">STP Port</a>	<a href="#">CIST</a>	<a href="#">CIST Port</a>	<a href="#">MST</a>	<a href="#">MST Port</a>
Priority	32768						
Max Hops	20	(1-40)					
Forward Delay	15	(4-30)					
Max Age	20	(6-40)					
Tx Hold Count	6	(1-10)					
Hello Time	2	(1-10)					
<input type="button" value="Apply"/> <input type="button" value="Cancel"/>							

The following table describes the labels in this screen.

Table 117 Configuration &gt; Spanning Tree &gt; CIST

LABEL	DESCRIPTION
CIST Instance	
Priority	Configure priority of CIST bridge ID. Priority is part of bridge ID, used for CIST root bridge selection.
Max Hops	Enter a maximum number of hops value. The value can be between 1 and 40.
Forward Delay	This is the maximum time (in seconds) a switch will wait before changing states. This delay is required because every switch must receive information about topology changes before it starts to forward frames. In addition, each port needs time to listen for conflicting information that would make it return to a blocking state; otherwise, temporary data loops might result. The allowed range is 4 to 30 seconds.  As a general rule: $2 * (\text{Forward Delay} - 1) \geq \text{Max Age} \geq 2 * (\text{Hello Time} + 1)$
Max Age	This is the maximum time (in seconds) a switch can wait without receiving a BPDU before attempting to reconfigure. All switch ports (except for designated ports) should receive BPDUs at regular intervals. Any port that ages out STP information (provided in the last BPDU) becomes the designated port for the attached LAN. If it is a root port, a new root port is selected from among the switch ports attached to the network. The allowed range is 6 to 40 seconds.
Tx Hold Count	Enter a transmission hold count value. The value can be between 1 and 10.
Hello Time	This is the time interval in seconds between BPDU (Bridge Protocol Data Units) configuration message generations by the root switch. The allowed range is 1 to 10 seconds.

Table 117 Configuration > Spanning Tree > CIST (continued)

LABEL	DESCRIPTION
Apply	Click <b>Apply</b> to save the changes.
Cancel	Click <b>Cancel</b> to discard the changes.

## 27.2.5 The CIST Port Screen

Use this screen to view the **CIST Port** settings. Click **Configuration > Spanning Tree > CIST Port** to open this screen.

Figure 156 Configuration > Spanning Tree > CIST Port

CIST Port		Global	STP Port	CIST	CIST Port	MST	MST Port
<input type="checkbox"/>	Port	Priority	External Path Cost	Internal Path Cost			
<input type="checkbox"/>	1	128	0	0			
<input type="checkbox"/>	2	128	0	0			
<input type="checkbox"/>	3	128	0	0			
<input type="checkbox"/>	4	128	0	0			
<input type="checkbox"/>	5	128	0	0			
<input type="checkbox"/>	6	128	0	0			
<input type="checkbox"/>	7	128	0	0			
<input type="checkbox"/>	24	128	0	0			
<input type="checkbox"/>	25	128	0	0			
<input type="checkbox"/>	26	128	0	0			
<input type="checkbox"/>	LAG1	128	0	0			
<input type="checkbox"/>	LAG2	128	0	0			
<input type="checkbox"/>	LAG3	128	0	0			
<input type="checkbox"/>	LAG4	128	0	0			
<input type="checkbox"/>	LAG5	128	0	0			
<input type="checkbox"/>	LAG6	128	0	0			
<input type="checkbox"/>	LAG7	128	0	0			
<input type="checkbox"/>	LAG8	128	0	0			

The following table describes the labels in this screen.

Table 118 Configuration > Spanning Tree > CIST Port

LABEL	DESCRIPTION
CIST Port	
Port	Displays the index number of the STP port.
Priority	Displays the priority for each port here.
External Path Cost	Displays the external path cost.
Internal Path Cost	Displays the internal path cost.
Edit	Select this check box to configure the properties of a port. Click the <b>Edit</b> button change the properties of the port.
Cancel	Click <b>Cancel</b> to discard the changes.

## 27.2.6 The CIST Port Edit Screen

Use this screen to configure the **CIST Port Edit** settings. Click **Configuration > Spanning Tree > CIST Port > Edit** to open this screen.

**Figure 157** Configuration > Spanning Tree > CIST Port > Edit

The following table describes the labels in this screen.

**Table 119** Configuration > Spanning Tree > CIST Port > Edit

LABEL	DESCRIPTION
STP CIST Port	
Port List	Enter the index number of the STP port(s).
Priority	Configure the priority for each port here.  Priority decides which port should be disabled when more than one port forms a loop in a switch. Ports with a higher priority numeric value are disabled first. The allowed range is between 0 and 255 and the default value is 128.
Internal Path Cost (0=Auto)	Enter the internal path cost. Enter 0 or Auto.
Apply	Click <b>Apply</b> to save the changes.
Cancel	Click <b>Cancel</b> to discard the changes.

## 27.2.7 The MST Screen

Use this screen to view the **MST** settings. Click **Configuration > Spanning Tree > MST** to open this screen.

**Figure 158** Configuration > Spanning Tree > MST

The following table describes the labels in this screen.

**Table 120** Configuration > Spanning Tree > MST

LABEL	DESCRIPTION
MST Instance	
MSTI	This displays the Multiple Spanning Tree Instance(s) (MSTI).
VLAN List	This displays a list of MSTI VLANs.
VLAN Count	This displays the VLAN count.
Priority	This displays the priority for each port here.

Table 120 Configuration &gt; Spanning Tree &gt; MST (continued)

LABEL	DESCRIPTION
Action	
Edit	Click <b>Edit</b> to make changes to the entry.
Delete	Click <b>Delete</b> to remove the entry.
Add	Click <b>Add</b> to create a new <b>MST Instance</b> entry.

## 27.2.8 The Add/Edit MST Screen

Use this screen to configure the **MST** settings. Click **Configuration > Spanning Tree > MST > Add/Edit** to open this screen.

Figure 159 Configuration &gt; Spanning Tree &gt; MST &gt; Add/Edit

MST Instance		<a href="#">Global</a>	<a href="#">STP Port</a>	<a href="#">CIST</a>	<a href="#">CIST Port</a>	<a href="#">MST</a>	<a href="#">MST Port</a>
MSTI ID	1						
VLAN List					(1-4094)		
Priority	32768						
<input type="button" value="Apply"/> <input type="button" value="Cancel"/>							

The following table describes the labels in this screen.

Table 121 Configuration &gt; Spanning Tree &gt; MST &gt; Add/Edit

LABEL	DESCRIPTION
MST Instance	
MST ID	Select a Multiple Spanning Tree Instance (MSTI) ID.
VLAN List	Enter a MSTI VLAN ID
Priority	Select a MSTI bridge ID priority value.
Apply	Click <b>Apply</b> to save the changes.
Cancel	Click <b>Cancel</b> to discard the changes.

## 27.2.9 The MST Port Screen

Use this screen to view the **MST Port** settings. Click **Configuration > Spanning Tree > MST Port** to open this screen.

Figure 160 Configuration &gt; Spanning Tree &gt; MST Port

MST Port		<a href="#">Global</a>	<a href="#">STP Port</a>	<a href="#">CIST</a>	<a href="#">CIST Port</a>	<a href="#">MST</a>	<a href="#">MST Port</a>
MST ID	1						
<input type="checkbox"/>	Port	MSTI ID	Priority	Internal Path Cost			
<input type="checkbox"/>	1	1	128	0			
<input type="checkbox"/>	2	1	128	0			
<input type="checkbox"/>	3	1	128	0			
<input type="checkbox"/>	4	1	128	0			
<input type="checkbox"/>	5	1	128	0			
<input type="checkbox"/>	6	1	128	0			
<input type="checkbox"/>	7	1	128	0			
<input type="checkbox"/>	24	1	128	0			
<input type="checkbox"/>	25	1	128	0			
<input type="checkbox"/>	26	1	128	0			
<input type="checkbox"/>	LAG1	1	128	0			
<input type="checkbox"/>	LAG2	1	128	0			
<input type="checkbox"/>	LAG3	1	128	0			
<input type="checkbox"/>	LAG4	1	128	0			
<input type="checkbox"/>	LAG5	1	128	0			
<input type="checkbox"/>	LAG6	1	128	0			
<input type="checkbox"/>	LAG7	1	128	0			
<input type="checkbox"/>	LAG8	1	128	0			
		<a href="#">Edit</a>		<a href="#">Cancel</a>			

The following table describes the labels in this screen.

Table 122 Configuration &gt; Spanning Tree &gt; MST Port

LABEL	DESCRIPTION
MST Port	
MST ID	Select the MST port ID number from the dropdown list.
Port	This displays the index number of the MST port.
MSTI ID	This displays the index value of the MSTI.
Priority	This displays the priority for each port.
Internal Path Cost	This displays the internal path cost.
Edit	Select this check box to configure the properties of a port. Click the <b>Edit</b> button change the properties of the port.
Cancel	Click <b>Cancel</b> to discard the changes.

## 27.2.10 The MST Port Edit Screen

Use this screen to configure the **MST Port Edit** settings. Click **Configuration > Spanning Tree > MST Port > Edit** to open this screen.



Figure 161 Configuration &gt; Spanning Tree &gt; MST Port &gt; Edit

MST Port		<a href="#">Global</a>	<a href="#">STP Port</a>	<a href="#">CIST</a>	<a href="#">CIST Port</a>	<a href="#">MST</a>	<a href="#">MST Port</a>
MSTI ID	1						
Port List							
Priority	128 ▼						
Internal Path Cost(0 = Auto)	0						
<input type="button" value="Apply"/> <input type="button" value="Cancel"/>							

The following table describes the labels in this screen.

Table 123 Configuration &gt; Spanning Tree &gt; MST Port &gt; Edit

LABEL	DESCRIPTION
STP MST Port	
MST ID	This displays the MST ID number.
Port List	Enter the index number of the MTP port(s).
Priority	Configure the priority for each port here.  Priority decides which port should be disabled when more than one port forms a loop in a switch. Ports with a higher priority numeric value are disabled first. The allowed range is between 0 and 255 and the default value is 128.
Internal Path Cost (0=Auto)	Enter the internal path cost. Enter 0 for Auto.
Apply	Click <b>Apply</b> to save the changes.
Cancel	Click <b>Cancel</b> to discard the changes.

# CHAPTER 28

## Configuration: LLDP

### 28.1 Overview

This section provides information for LLDP in **Configuration**.

Use the **Link Layer Discovery Protocol (LLDP)** screens to configure LLDP Switch settings.

### 28.2 LLDP

This page allows the user to inspect and configure the current LLDP port settings.

#### 28.2.1 The Global Screen

Use this screen to configure the **Global** settings. Click **Configuration > LLDP > Global** to open this screen.

**Figure 162** Configuration > LLDP > Global

Global		<a href="#">Global</a>	<a href="#">Port</a>	<a href="#">Local Information</a>	<a href="#">MED Network Policy</a>	<a href="#">MED Port</a>
State	<input checked="" type="radio"/> Enable <input type="radio"/> Disable					
Transmission Interval	30	(5-32768 sec)				
Hold Multiplier	4	(2-10)				
Reinitialization Delay	2	(1-10 sec)				
Transmit Delay	2	(1-8192 sec)				
LLDP-MED Fast Start Repeat Count	3	(1-10)				

[Apply](#) [Cancel](#)

The following table describes the labels in this screen.

**Table 124** Configuration > LLDP > Global

LABEL	DESCRIPTION
Global	
State	Select <b>Enable</b> to activate the global LLDP.
Transmission Interval	Enter the transmission interval value. The switch periodically transmits LLDP frames to its neighbors for having the network discovery information up-to-date. The interval between each LLDP frame is determined by the Tx Interval value. Valid values are restricted to 5 - 32768 seconds.

Table 124 Configuration &gt; LLDP &gt; Global (continued)

LABEL	DESCRIPTION
Hold Multiplier	Enter the hold multiplier value.  Each LLDP frame contains information about how long the information in the LLDP frame shall be considered valid. The LLDP information valid period is set to Tx Hold multiplied by Tx Interval seconds. Valid values are restricted to 2 - 10 times.
Reinitialization Delay	Enter the reinitialization delay value.  When a port is disabled, LLDP is disabled or the switch is rebooted, an LLDP shutdown frame is transmitted to the neighboring units, signaling that the LLDP information isn't valid anymore. Tx Reinit controls the amount of seconds between the shutdown frame and a new LLDP initialization. Valid values are restricted to 1 - 10 seconds.
Transmit Delay	Enter the transmission delay value.  If some configuration is changed (e.g. the IP address) a new LLDP frame is transmitted, but the time between the LLDP frames will always be at least the value of Tx Delay seconds. Tx Delay cannot be larger than 1/4 of the Tx Interval value. Valid values are restricted to 1 - 8192 seconds.
LLDP-MED Fast Start Repeat Count	Enter the LLDP-MED fast start repeat count value.  Because there is a risk of an LLDP frame being lost during transmission between neighbors, it is recommended to repeat the fast start transmission multiple times to increase the possibility of the neighbors receiving the LLDP frame. With Fast start repeat count it is possible to specify the number of times the fast start transmission would be repeated. The recommended value is 4 times, given that 4 LLDP frames with a 1 second interval will be transmitted, when an LLDP frame with new information is received.
Apply	Click <b>Apply</b> to save the changes.
Cancel	Click <b>Cancel</b> to discard the changes.

## 28.2.2 The Port Screen

Use this screen to view the **Port** settings. Click **Configuration > LLDP > Port** to open this screen.

Figure 163 Configuration &gt; LLDP &gt; Port

LLDP Port		<a href="#">Global</a>	<a href="#">Port</a>	<a href="#">Local Information</a>	<a href="#">MED Network Policy</a>	<a href="#">MED Port</a>
<input type="checkbox"/>	Port	Mode	Optional TLV Select			
<input type="checkbox"/>	1	Tx & Rx	SN, PD, SD, SC, MP, MA			
<input type="checkbox"/>	2	Tx & Rx	SN, PD, SD, SC, MP, MA			
<input type="checkbox"/>	3	Tx & Rx	SN, PD, SD, SC, MP, MA			
<input type="checkbox"/>	4	Tx & Rx	SN, PD, SD, SC, MP, MA			
<input type="checkbox"/>	5	Tx & Rx	SN, PD, SD, SC, MP, MA			
<input type="checkbox"/>	6	Tx & Rx	SN, PD, SD, SC, MP, MA			
<input type="checkbox"/>	7	Tx & Rx	SN, PD, SD, SC, MP, MA			
<input type="checkbox"/>	8	Tx & Rx	SN, PD, SD, SC, MP, MA			
<input type="checkbox"/>	9	Tx & Rx	SN, PD, SD, SC, MP, MA			
<input type="checkbox"/>	10	Tx & Rx	SN, PD, SD, SC, MP, MA			
<input type="checkbox"/>	21	Tx & Rx	SN, PD, SD, SC, MP, MA			
<input type="checkbox"/>	22	Tx & Rx	SN, PD, SD, SC, MP, MA			
<input type="checkbox"/>	23	Tx & Rx	SN, PD, SD, SC, MP, MA			
<input type="checkbox"/>	24	Tx & Rx	SN, PD, SD, SC, MP, MA			
<input type="checkbox"/>	25	Tx & Rx	SN, PD, SD, SC, MP, MA			
<input type="checkbox"/>	26	Tx & Rx	SN, PD, SD, SC, MP, MA			

 SN: System Name      PD: Port Description  
SD: System Description      SC: System Capability  
MP: 802.3 MAC-PHY      LA: 802.3 Link Aggregation  
MFS: 802.3 Maximum Frame Size      MA: Management Address

The following table describes the labels in this screen.

Table 125 Configuration &gt; LLDP &gt; Port

LABEL	DESCRIPTION
LLDP VLAN	
Port	Displays the index number of the LLDP port.
Mode	Displays the mode of the LLDP port as <b>Disable</b> , <b>Tx Only</b> , <b>Rx Only</b> , or <b>Tx &amp; Rx</b> .
Optional TLV Select	Displays the TLV as one or more of the following options: <ul style="list-style-type: none"> <li>• SN - System Name</li> <li>• PD - Port Description</li> <li>• SD - System Description</li> <li>• SC - System Capability</li> <li>• MP - 802.3 MAC-PHY</li> <li>• LA - 802.3 Link Aggregation</li> <li>• MFS - 802.3 Maximum Frame Size</li> <li>• MA - Management Address</li> </ul>
Edit	Select this check box to configure the properties of a port. Click the <b>Edit</b> button change the properties of the port.
Cancel	Click <b>Cancel</b> to discard the changes.

## 28.2.3 The Port Edit Screen

Use this screen to configure the **Port Edit** settings. Click **Configuration > LLDP > Port > Edit** to open this screen.

Figure 164 Configuration &gt; LLDP &gt; Port &gt; Edit

The following table describes the labels in this screen.

Table 126 Configuration &gt; LLDP &gt; Port &gt; Edit

LABEL	DESCRIPTION
LLDP Port	
Port List	Displays the index number of the LLDP port(s).
Mode	Select the mode of the LLDP port as <b>Disable</b> , <b>Tx Only</b> , <b>Rx Only</b> , or <b>Tx &amp; Rx</b> .
Optional TLV Select	Select the TLV as one or more of the following options: <ul style="list-style-type: none"> <li>• <b>SN</b> - System Name</li> <li>• <b>PD</b> - Port Description</li> <li>• <b>SD</b> - System Description</li> <li>• <b>SC</b> - System Capability</li> <li>• <b>MP</b> - 802.3 MAC-PHY</li> <li>• <b>LA</b> - 802.3 Link Aggregation</li> <li>• <b>MFS</b> - 802.3 Maximum Frame Size</li> <li>• <b>MA</b> - Management Address</li> </ul>
Apply	Click <b>Apply</b> to save the changes.
Cancel	Click <b>Cancel</b> to discard the changes.

## 28.2.4 The Local Information Screen

Use this screen to view the **Local Information** settings. Click **Configuration > LLDP > Local Information** to open this screen.

Figure 165 Configuration &gt; LLDP &gt; Local Information

Local Information		<a href="#">Global</a>	<a href="#">Port</a>	<a href="#">Local Information</a>	<a href="#">MED Network Policy</a>	<a href="#">MED Port</a>
Chassis ID Subtype	MAC Address					
Chassis ID	4C:9E:FF:72:4A:87					
System Name	GS1900					
System Description	GS1900-24HP					
Capabilities Supported	Bridge					
Capabilities Enable	Bridge					
Port ID Subtype	Interface name					

MED Port Location				
<input type="checkbox"/>	Port	Coordinate	Civic Address	ECS ELIN
<input type="checkbox"/>	1	Latitude:0.0000 North, Longitude:0.0000 East, Altitude:0.0000 , Map Datum:	---	---
<input type="checkbox"/>	2	Latitude:0.0000 North, Longitude:0.0000 East, Altitude:0.0000 , Map Datum:	---	---
<input type="checkbox"/>	3	Latitude:0.0000 North, Longitude:0.0000 East, Altitude:0.0000 , Map Datum:	---	---
<input type="checkbox"/>	4	Latitude:0.0000 North, Longitude:0.0000 East, Altitude:0.0000 , Map Datum:	---	---
<input type="checkbox"/>	5	Latitude:0.0000 North, Longitude:0.0000 East, Altitude:0.0000 , Map Datum:	---	---
<input type="checkbox"/>	22	Latitude:0.0000 North, Longitude:0.0000 East, Altitude:0.0000 , Map Datum:	---	---
<input type="checkbox"/>	23	Latitude:0.0000 North, Longitude:0.0000 East, Altitude:0.0000 , Map Datum:	---	---
<input type="checkbox"/>	24	Latitude:0.0000 North, Longitude:0.0000 East, Altitude:0.0000 , Map Datum:	---	---
<input type="checkbox"/>	25	Latitude:0.0000 North, Longitude:0.0000 East, Altitude:0.0000 , Map Datum:	---	---
<input type="checkbox"/>	26	Latitude:0.0000 North, Longitude:0.0000 East, Altitude:0.0000 , Map Datum:	---	---

[Edit](#) [Cancel](#)

The following table describes the labels in this screen.

Table 127 Configuration &gt; LLDP &gt; Local Information

LABEL	DESCRIPTION
Local Information	
Chassis ID Subtype	Displays the chassis ID subtype.
Chassis ID	The <b>Chassis ID</b> is the identification of the neighbor's LLDP frames.
System Name	<b>System Name</b> is the name advertised by the neighbor unit.
System Description	Displays the <b>System Description</b> .

Table 127 Configuration &gt; LLDP &gt; Local Information (continued)

LABEL	DESCRIPTION
Capabilities Supported	<p><b>Capabilities Supported</b> describes the neighbor unit's capabilities. The possible capabilities are:</p> <ol style="list-style-type: none"> <li>1. Other</li> <li>2. Repeater</li> <li>3. Bridge</li> <li>4. WLAN Access Point</li> <li>5. Router</li> <li>6. Telephone</li> <li>7. DOCSIS cable device</li> <li>8. Station only</li> <li>9. Reserved</li> </ol> <p>When a capability is enabled, the capability is followed by (+). If the capability is disabled, the capability is followed by (-).</p>
Capabilities Enable	Displays which capability is enabled.
Port ID Subtype	Displays the <b>Port ID Subtype</b> .
MED Port Location	
Port	Displays the index number of the LLDP port(s).
Coordinate	Displays the location coordinate of the LLDP port(s).
Civic Address	Displays the location of the civic address(es) in hexadecimal.
ECS ELIN	<p>Emergency Call Service (e.g. E911 and others), such as defined by TIA or NENA.</p> <p>Emergency Call Service ELIN identifier data format is defined to carry the ELIN identifier as used during emergency call setup to a traditional CAMA or ISDN trunk-based PSAP. This format consists of a numerical digit string, corresponding to the ELIN to be used for emergency calling.</p>
Edit	Select this check box to configure the properties of a port. Click the <b>Edit</b> button change the properties of the port.
Cancel	Click <b>Cancel</b> to discard the changes.

## 28.2.5 The Local Information Edit Screen

Use this screen to configure the **Port Edit** settings. Click **Configuration > LLDP > Local Information > Edit** to open this screen.

Figure 166 Configuration &gt; LLDP &gt; Local Information &gt; Edit

MED Port Location		Global	Port	Local Information	MED Network Policy	MED Port
Port List						
Location Coordinate	Latitude	0.0000	°	North	▼	
	Longitude	0.0000	°	East	▼	
	Altitude	0.0000		Meters	▼	
	MapDatum	WGS84				
Location Civic Address	Country code	<input type="text"/>				
	State	<input type="text"/>				
	Country	<input type="text"/>				
	City	<input type="text"/>				
	City district	<input type="text"/>				
	Block (Neighbourhood)	<input type="text"/>				
	Street	<input type="text"/>				
	Leading street direction	<input type="text"/>				
	Trailing street suffix	<input type="text"/>				
	Street suffix	<input type="text"/>				
	House no.	<input type="text"/>				
	House no. suffix	<input type="text"/>				
	Landmark	<input type="text"/>				
	Additional location info	<input type="text"/>				
	Name	<input type="text"/>				
	Zip code	<input type="text"/>				
	Building	<input type="text"/>				
	Apartment	<input type="text"/>				
	Floor	<input type="text"/>				
Room no.	<input type="text"/>					
Place type	<input type="text"/>					
Postal community name	<input type="text"/>					
P.O. Box	<input type="text"/>					
Location ECS ELIN	<input type="text"/>					
<input type="button" value="Apply"/> <input type="button" value="Cancel"/>						

The following table describes the labels in this screen.

Table 128 Configuration &gt; LLDP &gt; Local Information &gt; Edit

LABEL	DESCRIPTION
MED Port Location	
Port List	Displays the index number of the LLDP port(s). The value is made of 16 pairs of hexadecimal characters.
Location Coordinates	
Latitude	<b>Latitude</b> SHOULD be normalized to within 0-90 degrees with a maximum of 4 digits. It is possible to specify the direction to either <b>North</b> of the equator or <b>South</b> of the equator.
Longitude	<b>Longitude</b> SHOULD be normalized to within 0-180 degrees with a maximum of 4 digits. It is possible to specify the direction to either <b>East</b> of the prime meridian or <b>West</b> of the prime meridian.



Table 128 Configuration &gt; LLDP &gt; Local Information &gt; Edit (continued)

LABEL	DESCRIPTION
Altitude	<p><b>Altitude</b> SHOULD be normalized to within -32767 to 32767 with a maximum of 4 digits.</p> <p>It is possible to select between two altitude types (floors or meters).</p> <p><b>Meters:</b> Representing meters of Altitude defined by the vertical datum specified.</p> <p><b>Floors:</b> Representing altitude in a form more relevant in buildings which have different floor-to-floor dimensions. An altitude = 0.0 is meaningful even outside a building, and represents ground level at the given latitude and longitude. Inside a building, 0.0 represents the floor level associated with ground level at the main entrance.</p>
Map Datum	<p>The <b>Map Datum</b> is used for the coordinates given in these options:</p> <p><b>WGS84:</b> (Geographical 3D) - World Geodesic System 1984, CRS Code 4327, Prime Meridian Name: Greenwich.</p> <p><b>NAD83/NAVD88:</b> North American Datum 1983, CRS Code 4269, Prime Meridian Name: Greenwich; The associated vertical datum is the North American Vertical Datum of 1988 (NAVD88). This datum pair is to be used when referencing locations on land, not near tidal water (which would use Datum = NAD83/MLLW).</p> <p><b>NAD83/MLLW:</b> North American Datum 1983, CRS Code 4269, Prime Meridian Name: Greenwich; The associated vertical datum is Mean Lower Low Water (MLLW). This datum pair is to be used when referencing locations on water/sea/ocean.</p>
Location Civic Address	<p>IETF Geopriv Civic Address based Location Configuration Information (Civic Address LCI).</p> <ul style="list-style-type: none"> <li>• <b>Country code:</b> The two-letter ISO 3166 country code in capital ASCII letters - Example: DK, DE or US.</li> <li>• <b>State:</b> National subdivisions (state, canton, region, province, prefecture).</li> <li>• <b>County:</b> County, parish, gun (Japan), district.</li> <li>• <b>City:</b> City, township, shi (Japan) - Example: Copenhagen.</li> <li>• <b>City district:</b> City division, borough, city district, ward, chou (Japan).</li> <li>• <b>Block (Neighborhood):</b> Neighborhood, block.</li> <li>• <b>Street:</b> Street - Example: Poppelvej.</li> <li>• <b>Leading street direction:</b> Leading street direction - Example: N.</li> <li>• <b>Trailing street suffix:</b> Trailing street suffix - Example: SW.</li> <li>• <b>Street suffix:</b> Street suffix - Example: Ave, Platz.</li> <li>• <b>House no.:</b> House number - Example: 21.</li> <li>• <b>House no. suffix:</b> House number suffix - Example: A, 1/2.</li> <li>• <b>Landmark:</b> Landmark or vanity address - Example: Columbia University.</li> <li>• <b>Additional location info:</b> Additional location info - Example: South Wing.</li> <li>• <b>Name:</b> Name (residence and office occupant) - Example: Flemming Jahn.</li> <li>• <b>Zip code:</b> Postal/zip code - Example: 2791.</li> <li>• <b>Building:</b> Building (structure) - Example: Low Library.</li> <li>• <b>Apartment:</b> Unit (Apartment, suite) - Example: Apt 42.</li> <li>• <b>Floor:</b> Floor - Example: 4.</li> <li>• <b>Room no.:</b> Room number - Example: 450F.</li> <li>• <b>Place type:</b> Place type - Example: Office.</li> <li>• <b>Postal community name:</b> Postal community name - Example: Leonia.</li> <li>• <b>P.O. Box:</b> Post office box (P.O. BOX) - Example: 12345.</li> </ul>
Location ECS ELIN	<p>Emergency Call Service (e.g. E911 and others), such as defined by TIA or NENA.</p> <p>Emergency Call Service ELIN identifier data format is defined to carry the ELIN identifier as used during emergency call setup to a traditional CAMA or ISDN trunk-based PSAP. This format consists of a numerical digit string, corresponding to the ELIN to be used for emergency calling.</p>
Apply	Click <b>Apply</b> to save the changes.
Cancel	Click <b>Cancel</b> to discard the changes.

## 28.2.6 The MED Network Policy Screen

Use this screen to view the **MED Network Policy** settings. Click **Configuration > LLDP > MED Network Policy** to open this screen.

**Figure 167** Configuration > LLDP > MED Network Policy

Network Policy Configuration			<a href="#">Global</a>	<a href="#">Port</a>	<a href="#">Local Information</a>	<a href="#">MED Network Policy</a>	<a href="#">MED Port</a>
No.	Application	VLAN ID	VLAN Tag	L2 Priority	DSCP Value	Action	
<input type="button" value="Add"/>							

The following table describes the labels in this screen.

**Table 129** Configuration > LLDP > MED Network Policy

LABEL	DESCRIPTION
Network Policy Configuration	
No.	Displays index of network policy.
Application	Displays the <b>Application type</b> indicating the primary function of the application(s).
VLAN ID	Displays the VLAN ID (VID) for the port as defined in IEEE 802.1Q-2003.
VLAN Tag	Displays the <b>VLAN Tag</b> value as <b>Tagged</b> or <b>Untagged</b> .
L2 Priority	Displays the L2 priority layer value.
DSCP Value	Displays the <b>DSCP Value</b> .
Action	
Edit	Click <b>Edit</b> to make changes to the entry.
Delete	Click <b>Delete</b> to remove the entry.
Add	Click <b>Add</b> to create a new <b>Network Policy Configuration</b> entry.

## 28.2.7 The MED Network Policy Add/Edit Screen

Use this screen to configure the **Port Edit** settings. Click **Configuration > LLDP > MED Network Policy > Add/Edit** to open this screen.

**Figure 168** Configuration > LLDP > MED Network Policy > Add/Edit

New Network Policy		<a href="#">Global</a>	<a href="#">Port</a>	<a href="#">Local Information</a>	<a href="#">MED Network Policy</a>	<a href="#">MED Port</a>
No.	1					
Application	Voice					
VLAN ID	1 (1-4094)					
VLAN Tag	<input type="radio"/> Tagged <input checked="" type="radio"/> Untagged					
L2 Priority	0 (0-7)					
DSCP Value	0 (0-63)					
<input type="button" value="Apply"/> <input type="button" value="Cancel"/>						

The following table describes the labels in this screen.

Table 130 Configuration > LLDP > MED Network Policy > Edit

LABEL	DESCRIPTION
New Network Policy	
No.	Select the index of network policy
Application	<p>Select the <b>Application</b> type indicating the primary function of the application(s) defined for this network policy, advertised by an Endpoint or Network Connectivity Device. The possible application types are shown below.</p> <ol style="list-style-type: none"> <li>1. <b>Voice</b> - for use by dedicated IP Telephony handsets and other similar appliances supporting interactive voice services. These devices are typically deployed on a separate VLAN for ease of deployment and enhanced security by isolation from data applications.</li> <li>2. <b>Voice Signaling</b> - for use in network topologies that require a different policy for the voice signaling than for the voice media.</li> <li>3. <b>Guest Voice</b> - to support a separate limited feature-set voice service for guest users and visitors with their own IP Telephony handsets and other similar appliances supporting interactive voice services.</li> <li>4. <b>Guest Voice Signaling</b> - for use in network topologies that require a different policy for the guest voice signaling than for the guest voice media.</li> <li>5. <b>Softphone Voice</b> - for use by softphone applications on typical data centric devices, such as PCs or laptops.</li> <li>6. <b>Video Conferencing</b> - for use by dedicated Video Conferencing equipment and other similar appliances supporting real-time interactive video/audio services.</li> <li>7. <b>Streaming Video</b> - for use by broadcast or multicast based video content distribution and other similar applications supporting streaming video services that require specific network policy treatment. Video applications relying on TCP with buffering would not be an intended use of this application type.</li> <li>8. <b>Video Signaling</b> - for use in network topologies that require a separate policy for the video signaling than for the video media.</li> </ol>
VLAN ID	Enter the <b>VLAN ID</b> (VID) for the port as defined in IEEE 802.1Q-2003. A value of 1 through 4094 is used to define a valid VLAN ID. A value of 0 (Priority Tagged) is used if the device is using priority tagged frames as defined by IEEE 802.1Q-2003, meaning that only the IEEE 802.1D priority level is significant and the default PVID of the ingress port is used instead.
VLAN Tag	<p><b>TAG</b> is indicative of whether the specified application type is using a tagged or an untagged VLAN. Select <b>Tagged</b> or <b>Untagged</b>.</p> <p><b>Untagged:</b> The device is using an untagged frame format and as such does not include a tag header as defined by IEEE 802.1Q-2003.</p> <p><b>Tagged:</b> The device is using the IEEE 802.1Q tagged frame format.</p>
L2 Priority	<b>Priority</b> is the Layer 2 priority to be used for the specified application type. One of the eight priority levels (0 through 7).
DSCP Value	<b>DSCP</b> is the DSCP value to be used to provide Diffserv node behavior for the specified application type as defined in IETF RFC 2474. Contain one of 64 code point values (0 through 63).
Apply	Click <b>Apply</b> to save the changes.
Cancel	Click <b>Cancel</b> to discard the changes.

## 28.2.8 The MED Port Screen

Use this screen to view the **MED Port** settings. Click **Configuration > LLDP > MED Port** to open this screen.

Figure 169 Configuration &gt; LLDP &gt; MED Port

MED Port		Global	Port	Local Information	MED Network Policy	MED Port
<input type="checkbox"/>	Port	State	Network Policy	Location	PoE	Inventory
<input type="checkbox"/>	1	Disable	No	No	No	No
<input type="checkbox"/>	2	Disable	No	No	No	No
<input type="checkbox"/>	3	Disable	No	No	No	No
<input type="checkbox"/>	4	Disable	No	No	No	No
<input type="checkbox"/>	5	Disable	No	No	No	No
<input type="checkbox"/>	6	Disable	No	No	No	No
<input type="checkbox"/>	21	Disable	No	No	No	No
<input type="checkbox"/>	22	Disable	No	No	No	No
<input type="checkbox"/>	23	Disable	No	No	No	No
<input type="checkbox"/>	24	Disable	No	No	No	No
<input type="checkbox"/>	25	Disable	No	No	No	No
<input type="checkbox"/>	26	Disable	No	No	No	No

The following table describes the labels in this screen.

Table 131 Configuration &gt; LLDP &gt; MED Port

LABEL	DESCRIPTION
MED Port	
Port	Displays the <b>MED Port</b> value.
State	Displays the state of the MED port as <b>Enable</b> or <b>Disable</b> .
Network Policy	Displays the <b>Network Policy</b> value.
Location	Displays the <b>Location</b> value.
PoE	Displays the <b>PoE</b> value.
Inventory	Displays the <b>Inventory</b> value.
Edit	Select this check box to configure the properties of a port. Click the <b>Edit</b> button change the properties of the port.
Cancel	Click <b>Cancel</b> to discard the changes.

## 28.2.9 The MED Port Edit Screen

Use this screen to configure the MED Port Edit settings. Click **Configuration > LLDP > MED Port > Edit** to open this screen.

Figure 170 Configuration &gt; LLDP &gt; MED Port &gt; Edit

The following table describes the labels in this screen.

Table 132 Configuration &gt; LLDP &gt; MED Port &gt; Edit

LABEL	DESCRIPTION
MED Port	
Port List	Displays the <b>Port List</b> .
State	Select <b>Enable</b> to activate the MED Port feature.
MED Optional TLVs	Select one or more of the MED Optional TLVs: <ul style="list-style-type: none"> <li>• <b>Network Policy</b></li> <li>• <b>Location</b></li> <li>• <b>PoE PSE</b></li> <li>• <b>Inventory</b></li> </ul>
MED Network Policy	Select one or more of the <b>MED Network Policies</b> in <b>Available</b> and move them to <b>Acting</b> to activate.
Apply	Click <b>Apply</b> to save the changes.
Cancel	Click <b>Cancel</b> to discard the changes.

# CHAPTER 29

## Configuration: QoS

### 29.1 Overview

This section provides information for **QoS** (Quality of Service) in **Configuration**.

### 29.2 General

Quality of Service (QoS) refers to both a network's ability to deliver data with minimum delay, and the networking methods used to control the use of bandwidth. Without QoS, all traffic data is equally likely to be dropped when the network is congested. This can cause a reduction in network performance and make the network inadequate for time-critical application such as video-on-demand.

#### 29.2.1 The Port Screen

Use this screen to view the **Port** settings. Click **Configuration** > **QoS** > **General** > **Port** to open this screen.

Figure 171 Configuration &gt; QoS &gt; General &gt; Port

QoS Port		<a href="#">Port</a>	<a href="#">Queue</a>	<a href="#">CoS Mapping</a>	<a href="#">DSCP Mapping</a>	<a href="#">IP Precedence Mapping</a>
<input type="checkbox"/>	Port	CoS Value	Remark CoS	Remark DSCP	Remark IP Precedence	
<input type="checkbox"/>	1	0	Disable	Disable	Disable	
<input type="checkbox"/>	2	0	Disable	Disable	Disable	
<input type="checkbox"/>	3	0	Disable	Disable	Disable	
<input type="checkbox"/>	4	0	Disable	Disable	Disable	
<input type="checkbox"/>	5	0	Disable	Disable	Disable	
<input type="checkbox"/>	6	0	Disable	Disable	Disable	
<input type="checkbox"/>	7	0	Disable	Disable	Disable	
<input type="checkbox"/>	8	0	Disable	Disable	Disable	
<input type="checkbox"/>	9	0	Disable	Disable	Disable	
<input type="checkbox"/>	10	0	Disable	Disable	Disable	
<input type="checkbox"/>	11	0	Disable	Disable	Disable	
<input type="checkbox"/>	12	0	Disable	Disable	Disable	
<input type="checkbox"/>	13	0	Disable	Disable	Disable	
<input type="checkbox"/>	14	0	Disable	Disable	Disable	
<input type="checkbox"/>	15	0	Disable	Disable	Disable	
<input type="checkbox"/>	16	0	Disable	Disable	Disable	
<input type="checkbox"/>	17	0	Disable	Disable	Disable	
<input type="checkbox"/>	18	0	Disable	Disable	Disable	
<input type="checkbox"/>	19	0	Disable	Disable	Disable	
<input type="checkbox"/>	20	0	Disable	Disable	Disable	
<input type="checkbox"/>	21	0	Disable	Disable	Disable	
<input type="checkbox"/>	22	0	Disable	Disable	Disable	
<input type="checkbox"/>	23	0	Disable	Disable	Disable	
<input type="checkbox"/>	24	0	Disable	Disable	Disable	
<input type="checkbox"/>	25	0	Disable	Disable	Disable	
<input type="checkbox"/>	26	0	Disable	Disable	Disable	
<input type="checkbox"/>	LAG1	0	Disable	Disable	Disable	
<input type="checkbox"/>	LAG2	0	Disable	Disable	Disable	
<input type="checkbox"/>	LAG3	0	Disable	Disable	Disable	
<input type="checkbox"/>	LAG4	0	Disable	Disable	Disable	
<input type="checkbox"/>	LAG5	0	Disable	Disable	Disable	
<input type="checkbox"/>	LAG6	0	Disable	Disable	Disable	
<input type="checkbox"/>	LAG7	0	Disable	Disable	Disable	
<input type="checkbox"/>	LAG8	0	Disable	Disable	Disable	

The following table describes the labels in this screen.

Table 133 Configuration &gt; QoS &gt; General &gt; Port

LABEL	DESCRIPTION
QoS Port	
Port	Displays the QoS port list.
CoS Value	Displays the CoS value, range: 0 - 7.
Remark CoS	Displays if this function is disabled or enabled.
Remark DSCP	Displays if this function is disabled or enabled.
Remark IP Precedence	Displays if this function is disabled or enabled.
Edit	Select this check box to configure the properties of a port. Click the <b>Edit</b> button change the properties of the port.
Cancel	Click <b>Cancel</b> to discard the changes.

## 29.2.2 The Port Edit Screen

Use this screen to configure the **Port Edit** settings. Click **Configuration > QoS > General > Port > Edit** to open this screen.

Figure 172 Configuration &gt; QoS &gt; General &gt; Port &gt; Edit

QoS Port		<a href="#">Port</a>	<a href="#">Queue</a>	<a href="#">CoS Mapping</a>	<a href="#">DSCP Mapping</a>	<a href="#">IP Precedence Mapping</a>
Port List						
CoS Value	0					
CoS Remark	<input type="radio"/> Enable <input checked="" type="radio"/> Disable					
DSCP Remark	<input type="radio"/> Enable <input checked="" type="radio"/> Disable					
IP Precedence Remark	<input type="radio"/> Enable <input checked="" type="radio"/> Disable					
<input type="button" value="Apply"/> <input type="button" value="Cancel"/>						

The following table describes the labels in this screen.

Table 134 Configuration &gt; QoS &gt; General &gt; Port &gt; Edit

LABEL	DESCRIPTION
QoS Port	
Port List	Displays the index number of the QoS port(s).
CoS Value	Select the <b>CoS Value</b> from the dropdown list.
CoS Remark	Select Enable to activate <b>CoS Remark</b> .
DSCP Remark	Select Enable to activate <b>DSCP Remark</b> .
IP Precedence Remark	Select Enable to activate <b>IP Precedence Remark</b> .
Apply	Click <b>Apply</b> to save the changes.
Cancel	Click <b>Cancel</b> to discard the changes.

## 29.2.3 The Queue Screen

Use this screen to view the **Queue** settings. Click **Configuration > QoS > General > Queue** to open this screen.

Figure 173 Configuration &gt; QoS &gt; General &gt; Queue

QoS Queue		<a href="#">Port</a>	<a href="#">Queue</a>	<a href="#">CoS Mapping</a>	<a href="#">DSCP Mapping</a>	<a href="#">IP Precedence Mapping</a>
Queue ID	Schedule Algorithm Weight(1 - 127)					
0	<input checked="" type="radio"/> Strict <input type="radio"/> WRR	1				
1	<input checked="" type="radio"/> Strict <input type="radio"/> WRR	2				
2	<input checked="" type="radio"/> Strict <input type="radio"/> WRR	3				
3	<input checked="" type="radio"/> Strict <input type="radio"/> WRR	4				
4	<input checked="" type="radio"/> Strict <input type="radio"/> WRR	5				
5	<input checked="" type="radio"/> Strict <input type="radio"/> WRR	9				
6	<input checked="" type="radio"/> Strict <input type="radio"/> WRR	13				
7	<input checked="" type="radio"/> Strict <input type="radio"/> WRR	15				
<input type="button" value="Apply"/> <input type="button" value="Cancel"/>						



The following table describes the labels in this screen.

Table 135 Configuration &gt; QoS &gt; General &gt; Queue

LABEL	DESCRIPTION
QoS Queue	
Queue ID	Displays the <b>Queue ID</b> value.
Schedule Algorithm	Select the <b>Schedule Algorithm</b> as <b>Strict</b> or <b>WRR</b> .
Weight (1-127)	Enter the weight of the QoS item.
Apply	Click <b>Apply</b> to save the changes.
Cancel	Click <b>Cancel</b> to discard the changes.

## 29.2.4 The CoS Mapping Screen

Use this screen to configure the **Cos Mapping** settings. Click **Configuration > QoS > General > CoS Mapping** to open this screen.

Figure 174 Configuration &gt; QoS &gt; General &gt; CoS Mapping

The screenshot shows the CoS Mapping configuration interface. It features a title bar with the text 'CoS Mapping' and several navigation links: 'Port', 'Queue', 'CoS Mapping', 'DSCP Mapping', and 'IP Precedence Mapping'. The main content area is divided into two sections:

- CoS to Queue Mapping:** A table with two columns: 'Class of Service (CoS)' and 'Queue ID (0 - 7)'. The rows are numbered 0 through 7. Each row has a dropdown menu for the Queue ID value.
- Queue to CoS Mapping:** A table with two columns: 'Queue ID' and 'Class of Service (CoS) (0 - 7)'. The rows are numbered 0 through 7. Each row has a dropdown menu for the Class of Service value.

At the bottom right of the screen, there are two buttons: 'Apply' and 'Cancel'.

The following table describes the labels in this screen.

Table 136 Configuration &gt; QoS &gt; General &gt; CoS Mapping

LABEL	DESCRIPTION
CoS to Queue Mapping	
Class of Service (CoS)	Displays a listing of the CoS, range: 0 - 7.

Table 136 Configuration > QoS > General > CoS Mapping (continued)

LABEL	DESCRIPTION
Queue ID (0-7)	Click the drop-down menu to map the CoS to a specific Queue ID.
Queue to CoS Mapping	
Queue ID	Displays a listing of the Queue ID, range: 0 - 7.
Class of Service (CoS) (0-7)	Click the drop-down menu to map the Queue ID to a specific CoS.
Apply	Click <b>Apply</b> to save the changes.
Cancel	Click <b>Cancel</b> to discard the changes.

## 29.2.5 The DSCP Mapping Screen

Use this screen to configure the **DSCP Mapping** settings. Click **Configuration > QoS > General > DSCP Mapping** to open this screen.

Figure 175 Configuration > QoS > General > DSCP Mapping

DSCP Mapping

[Port](#)
[Queue](#)
[CoS Mapping](#)
[DSCP Mapping](#)
[IP Precedence Mapping](#)

**DSCP to Queue Mapping**

DSCP ( 0-7)	0	0 ▼	1	0 ▼	2	0 ▼	3	0 ▼
	4	0 ▼	5	0 ▼	6	0 ▼	7	0 ▼
DSCP ( 8-15)	8	1 ▼	9	1 ▼	10	1 ▼	11	1 ▼
	12	1 ▼	13	1 ▼	14	1 ▼	15	1 ▼
DSCP (16-23)	16	2 ▼	17	2 ▼	18	2 ▼	19	2 ▼
	20	2 ▼	21	2 ▼	22	2 ▼	23	2 ▼
DSCP (24-31)	24	3 ▼	25	3 ▼	26	3 ▼	27	3 ▼
	28	3 ▼	29	3 ▼	30	3 ▼	31	3 ▼
DSCP (32-39)	32	4 ▼	33	4 ▼	34	4 ▼	35	4 ▼
	36	4 ▼	37	4 ▼	38	4 ▼	39	4 ▼
DSCP (40-47)	40	5 ▼	41	5 ▼	42	5 ▼	43	5 ▼
	44	5 ▼	45	5 ▼	46	5 ▼	47	5 ▼
DSCP (48-55)	48	6 ▼	49	6 ▼	50	6 ▼	51	6 ▼
	52	6 ▼	53	6 ▼	54	6 ▼	55	6 ▼
DSCP (56-63)	56	7 ▼	57	7 ▼	58	7 ▼	59	7 ▼
	60	7 ▼	61	7 ▼	62	7 ▼	63	7 ▼

**Queue to DSCP Mapping**

Queue ID	DSCP (0 - 63)
0	0 ▼
1	8 ▼
2	16 ▼
3	24 ▼
4	32 ▼
5	40 ▼
6	48 ▼
7	56 ▼

Apply
Cancel

The following table describes the labels in this screen.

Table 137 Configuration > QoS > General > DSCP Mapping

LABEL	DESCRIPTION
DSCP Mapping	
DSCP to Queue Mapping	
Queue ID	Displays the DSCP <b>Queue ID</b> value.
Queue to DSCP Mapping	
DSCP (0-63)	Select the DSCP mapping value from the dropdown list.
Apply	Click <b>Apply</b> to save the changes.
Cancel	Click <b>Cancel</b> to discard the changes.

## 29.2.6 The IP Precedence Mapping Screen

Use this screen to configure the **IP Precedence Mapping** settings. Click **Configuration > QoS > General > IP Precedence Mapping** to open this screen.

Figure 176 Configuration > QoS > General > IP Precedence Mapping

**IP Precedence Mapping** [Port](#) [Queue](#) [CoS Mapping](#) [DSCP Mapping](#) [IP Precedence Mapping](#)

**IP Precedence to Queue Mapping**

IP Precedence	Queue ID (0 - 7)
0	0 ▼
1	1 ▼
2	2 ▼
3	3 ▼
4	4 ▼
5	5 ▼
6	6 ▼
7	7 ▼

**Queue to IP Precedence Mapping**

Queue ID	IP Precedence (0 - 7)
0	0 ▼
1	1 ▼
2	2 ▼
3	3 ▼
4	4 ▼
5	5 ▼
6	6 ▼
7	7 ▼

[Apply](#) [Cancel](#)

The following table describes the labels in this screen.

Table 138 Configuration > QoS > General > IP Precedence Mapping

LABEL	DESCRIPTION
IP Precedence Mapping	
IP Precedence to Queue Mapping	
IP Precedence	Displays a listing of IP Precedence, range: 0 - 7.

Table 138 Configuration &gt; QoS &gt; General &gt; IP Precedence Mapping (continued)

LABEL	DESCRIPTION
Queue ID (0-7)	Click the drop-down menu to map an IP Precedence designation to a specific Queue ID (0 - 7).
Queue to IP Precedence Mapping	
Queue ID	Displays a listing of Queue ID, range: 0 - 7.
IP Precedence (0-7)	Click the drop-down menu to map a Queue ID to a specific IP precedence.
Apply	Click <b>Apply</b> to save the changes.
Cancel	Click <b>Cancel</b> to discard the changes.

## 29.3 Trust Mode

### 29.3.1 The Global Screen

Use this screen to view the **Global** settings. Click **Configuration > QoS > Trust Mode > Global** to open this screen.

Figure 177 Configuration &gt; QoS &gt; Trust Mode &gt; Global

The following table describes the labels in this screen.

Table 139 Configuration &gt; QoS &gt; Trust Mode &gt; Global

LABEL	DESCRIPTION
Global	
Trust Mode	Select the <b>Trust Mode</b> from the dropdown list.
Apply	Click <b>Apply</b> to save the changes.
Cancel	Click <b>Cancel</b> to discard the changes.

### 29.3.2 The Port Screen

Use this screen to view the **Port** settings. Click **Configuration > QoS > Trust Mode > Port** to open this screen.

Figure 178 Configuration &gt; QoS &gt; Trust Mode &gt; Port

QoS Port		<a href="#">Global</a> <a href="#">Port</a>
<input type="checkbox"/>	Port	Mode
<input type="checkbox"/>	1	Untrust
<input type="checkbox"/>	2	Untrust
<input type="checkbox"/>	3	Untrust
<input type="checkbox"/>	4	Untrust
<input type="checkbox"/>	5	Untrust
<input type="checkbox"/>	6	Untrust
<input type="checkbox"/>	7	Untrust
<input type="checkbox"/>	8	Untrust
<input type="checkbox"/>	24	Untrust
<input type="checkbox"/>	25	Untrust
<input type="checkbox"/>	26	Untrust
<input type="checkbox"/>	LAG1	Untrust
<input type="checkbox"/>	LAG2	Untrust
<input type="checkbox"/>	LAG3	Untrust
<input type="checkbox"/>	LAG4	Untrust
<input type="checkbox"/>	LAG5	Untrust
<input type="checkbox"/>	LAG6	Untrust
<input type="checkbox"/>	LAG7	Untrust
<input type="checkbox"/>	LAG8	Untrust

[Edit](#) [Cancel](#)

The following table describes the labels in this screen.

Table 140 Configuration &gt; QoS &gt; Trust Mode &gt; Port

LABEL	DESCRIPTION
QoS Port	
Port	Displays the port index value.
Mode	Displays the Trust status as <b>Trust</b> or <b>Untrust</b> .
Edit	Select this check box to configure the properties of a port. Click the <b>Edit</b> button change the properties of the port.
Cancel	Click <b>Cancel</b> to discard the changes.

### 29.3.3 The Trust Mode Edit Screen

Use this screen to configure the **Trust Mode** settings. Click **Configuration > QoS > Trust Mode > Port > Edit** to open this screen.

Figure 179 Configuration &gt; QoS &gt; Trust Mode &gt; Port &gt; Edit

The following table describes the labels in this screen.

Table 141 Configuration &gt; QoS &gt; Trust Mode &gt; Port &gt; Edit

LABEL	DESCRIPTION
QoS Port	
Port List	Displays the port index value(s).
Mode	Select the <b>Trust Mode</b> for the QoS port list as <b>Trust</b> or <b>Untrust</b> .
Apply	Click <b>Apply</b> to save the changes.
Cancel	Click <b>Cancel</b> to discard the changes.

# CHAPTER 30

## Configuration: Security

### 30.1 Overview

This section provides information for **Security** in **Configuration**.

### 30.2 Port Security

#### 30.2.1 The Global Screen

Use this screen to view the **Global** settings. Click **Configuration > Security > Port Security > Global** to open this screen.

**Figure 180** Configuration > Security > Port Security > Global

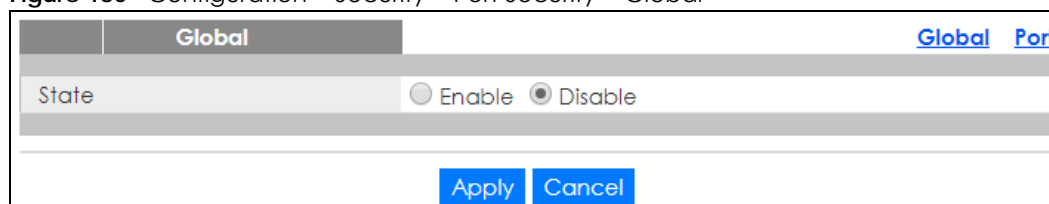

The screenshot shows a configuration screen with a header bar containing the word "Global" and two links, "Global" and "Port". Below the header is a "State" field with two radio buttons: "Enable" (unselected) and "Disable" (selected). At the bottom of the screen are two buttons: "Apply" and "Cancel".

The following table describes the labels in this screen.

**Table 142** Configuration > Security > Port Security > Global

LABEL	DESCRIPTION
Global	
State	Select the global security setting to be enabled or disabled.
Apply	Click <b>Apply</b> to save the changes.
Cancel	Click <b>Cancel</b> to discard the changes.

#### 30.2.2 The Port Screen

Use this screen to view the **Port** settings. Click **Configuration > Security > Port Security > Port** to open this screen.

Figure 181 Configuration &gt; Security &gt; Port Security &gt; Port

Port				Global	Port
<input type="checkbox"/>	Port	State	Max. MAC Entry Number	Action	
<input type="checkbox"/>	1	Disable	Unlimited	---	
<input type="checkbox"/>	2	Disable	Unlimited	---	
<input type="checkbox"/>	3	Disable	Unlimited	---	
<input type="checkbox"/>	4	Disable	Unlimited	---	
<input type="checkbox"/>	5	Disable	Unlimited	---	
<input type="checkbox"/>	6	Disable	Unlimited	---	
<input type="checkbox"/>	7	Disable	Unlimited	---	
<input type="checkbox"/>	23	Disable	Unlimited	---	
<input type="checkbox"/>	24	Disable	Unlimited	---	
<input type="checkbox"/>	25	Disable	Unlimited	---	
<input type="checkbox"/>	26	Disable	Unlimited	---	
<input type="checkbox"/>	LAG1	Disable	Unlimited	---	
<input type="checkbox"/>	LAG2	Disable	Unlimited	---	
<input type="checkbox"/>	LAG3	Disable	Unlimited	---	
<input type="checkbox"/>	LAG4	Disable	Unlimited	---	
<input type="checkbox"/>	LAG5	Disable	Unlimited	---	
<input type="checkbox"/>	LAG6	Disable	Unlimited	---	
<input type="checkbox"/>	LAG7	Disable	Unlimited	---	
<input type="checkbox"/>	LAG8	Disable	Unlimited	---	

The following table describes the labels in this screen.

Table 143 Configuration &gt; Security &gt; Port Security &gt; Port

LABEL	DESCRIPTION
Port	
Port	Displays the port index value.
State	Displays the Trust status as <b>Enable/Disable</b> .
Max. MAC Entry Number	Displays the designated maximum number of allowed MAC entries. The maximum MAC entry number can be learned for individual ports.
Action	Displays the <b>Action</b> as <b>Discard</b> or <b>Shutdown</b> .
Edit	Select this check box to configure the properties of a port. Click the <b>Edit</b> button change the properties of the port.
Cancel	Click <b>Cancel</b> to discard the changes.

### 30.2.3 The Port Edit Screen

Use this screen to configure the **Port** settings. Select the port(s) you want to configure and then click **Edit** in the **Configuration > Security > Port Security > Port** screen to open this screen.



Figure 182 Configuration &gt; Security &gt; Port Security &gt; Port &gt; Edit

Port Security		<a href="#">Global</a> <a href="#">Port</a>
Port List		
State	<input type="radio"/> Enable <input checked="" type="radio"/> Disable	
Max MAC Entry Number	<input type="text" value="256"/> (0-256)	
Action	<input checked="" type="radio"/> Discard <input type="radio"/> Shutdown	
<input type="button" value="Apply"/> <input type="button" value="Cancel"/>		

The following table describes the labels in this screen.

Table 144 Configuration &gt; Security &gt; Port Security &gt; Port &gt; Edit

LABEL	DESCRIPTION
Port Security	
Port List	Displays the port index value.
State	Select <b>Enable</b> or <b>Disable</b> for the Trust status.
Max MAC Entry Number	Enter the maximum MAC entry number (maximum MAC entry number can be learned for individual ports).
Action	Select the <b>Action</b> as <b>Discard</b> or <b>Shutdown</b> .
Apply	Click <b>Apply</b> to save the changes.
Cancel	Click <b>Cancel</b> to discard the changes.

## 30.3 Protected Port

### 30.3.1 The Protected Port Screen

Use this screen to view the **Port** settings. Click **Configuration > Security > Protected Port** to open this screen.

Figure 183 Configuration &gt; Security &gt; Protected Port

Protected Port	
<input type="checkbox"/> Port	State
<input type="checkbox"/> 1	Disable
<input type="checkbox"/> 2	Disable
<input type="checkbox"/> 3	Disable
<input type="checkbox"/> 4	Disable
<input type="checkbox"/> 5	Disable
<input type="checkbox"/> 6	Disable
<input type="checkbox"/> 7	Disable
<input type="checkbox"/> 19	Disable
<input type="checkbox"/> 20	Disable
<input type="checkbox"/> 21	Disable
<input type="checkbox"/> 22	Disable
<input type="checkbox"/> 23	Disable
<input type="checkbox"/> 24	Disable
<input type="checkbox"/> 25	Disable
<input type="checkbox"/> 26	Disable

The following table describes the labels in this screen.

Table 145 Configuration &gt; Security &gt; Protected Port

LABEL	DESCRIPTION
Protected Port	
Port	Displays the port index value.
State	Displays the Trust status as <b>Enable/Disable</b> .
Edit	Select this check box to configure the properties of a port. Click the <b>Edit</b> button change the properties of the port.
Cancel	Click <b>Cancel</b> to discard the changes.

### 30.3.2 The Protected Port Edit Screen

Use this screen to configure the **Port** settings. Click **Configuration > Security > Protected Port > Edit** to open this screen.

Figure 184 Configuration &gt; Security &gt; Protected Port &gt; Edit

Protected Port	
Port List	
State	<input type="radio"/> Enable <input checked="" type="radio"/> Disable

The following table describes the labels in this screen.

Table 146 Configuration > Security > Protected Port > Edit

LABEL	DESCRIPTION
Protected Port	
Port List	Displays the port list index value(s).
State	Select <b>Enable</b> or <b>Disable</b> for the <b>Protected Port</b> status.
Apply	Click <b>Apply</b> to save the changes.
Cancel	Click <b>Cancel</b> to discard the changes.

## 30.4 802.1X

### 30.4.1 The Global Screen

Use this screen to view the **Global** settings. Click **Configuration > Security > 802.1X > Global** to open this screen.

Figure 185 Configuration > Security > 802.1X > Global

The following table describes the labels in this screen.

Table 147 Configuration > Security > 802.1X > Global

LABEL	DESCRIPTION
Global	
State	Select the 802.1X security setting to be enabled or disabled.
Apply	Click <b>Apply</b> to save the changes.
Cancel	Click <b>Cancel</b> to discard the changes.

### 30.4.2 The Port Screen

Use this screen to view the **Port** settings. Click **Configuration > Security > 802.1X > Port** to open this screen.

Figure 186 Configuration &gt; Security &gt; 802.1X &gt; Port

Port							Global	Port
<input type="checkbox"/>	Port	State	Reauthentication	Reauthentication Period	Quiet Period	Supplicant Timeout	Maximum Request Retries	
<input type="checkbox"/>	1	No Authentication	Enable	3600	60	30	2	
<input type="checkbox"/>	2	No Authentication	Enable	3600	60	30	2	
<input type="checkbox"/>	3	No Authentication	Enable	3600	60	30	2	
<input type="checkbox"/>	4	No Authentication	Enable	3600	60	30	2	
<input type="checkbox"/>	5	No Authentication	Enable	3600	60	30	2	
<input type="checkbox"/>	6	No Authentication	Enable	3600	60	30	2	
<input type="checkbox"/>	7	No Authentication	Enable	3600	60	30	2	
<input type="checkbox"/>	8	No Authentication	Enable	3600	60	30	2	
<input type="checkbox"/>	21	No Authentication	Enable	3600	60	30	2	
<input type="checkbox"/>	22	No Authentication	Enable	3600	60	30	2	
<input type="checkbox"/>	23	No Authentication	Enable	3600	60	30	2	
<input type="checkbox"/>	24	No Authentication	Enable	3600	60	30	2	
<input type="checkbox"/>	25	No Authentication	Enable	3600	60	30	2	
<input type="checkbox"/>	26	No Authentication	Enable	3600	60	30	2	

The following table describes the labels in this screen.

Table 148 Configuration &gt; Security &gt; 802.1X &gt; Port

LABEL	DESCRIPTION
Port	
Port	Displays the port index value.
State	Displays the Trust status as enabled or disabled.
Reauthentication	Displays if Reauthentication function is enabled. If enabled, the subscriber has to periodically re-enter his or her username and password to stay connected to the port.
Reauthentication Period	Displays the Reauthentication period for the function: the period of time when a client has to re-enter his or her username and password to stay connected to the port.
Quiet Period	Display the time out period to transmit request after receiving a rejection from the sever.
Supplicant Time out	Display the time out period to transmit a request when the client does not respond.
Maximum Request Retries	Enter the maximum number of request retries.
Edit	Select this check box to configure the properties of a port. Click the <b>Edit</b> button change the properties of the port.
Cancel	Click <b>Cancel</b> to discard the changes.

### 30.4.3 The Port Edit Screen

Use this screen to configure the **Port** settings. Click **Configuration > Security > 802.1X > Port > Edit** to open this screen.

**Figure 187** Configuration > Security > 802.1X > Port > Edit

802.1x Port		<a href="#">Global</a> <a href="#">Port</a>
Port List		
State	No Authentication ▼	
Reauthentication State	<input checked="" type="radio"/> Enable <input type="radio"/> Disable	
Reauthentication Period	3600	(30 - 65535 sec)
Quiet Period	60	(0 - 65535 sec)
Supplicant Period	30	(1 - 65535 sec)
Maximum Request Retries	2	(1 - 10)
<input type="button" value="Apply"/> <input type="button" value="Cancel"/>		

The following table describes the labels in this screen.

**Table 149** Configuration > Security > 802.1X > Port > Edit

LABEL	DESCRIPTION
802.1X Port	
Port List	Displays the port index value.
State	Displays the Trust status as enabled or disabled.
Reauthentication State	Specify if a subscriber has to periodically re-enter his or her username and password to stay connected to the port. Select <b>Enable</b> to activate feature.
Reauthentication Period	Specify how often a client has to re-enter his or her username and password to stay connected to the port.
Quiet Period	Display the time out period to transmit request after receiving a rejection from the sever.
Supplicant Period	Display the time out period to transmit a request when the client does not respond.
Maximum Request Retries	Enter the maximum number of request retries.
Apply	Click <b>Apply</b> to save the changes.
Cancel	Click <b>Cancel</b> to discard the changes.

## 30.5 DoS

The Switch protects against Denial of Service (DoS) attacks, such as Scan attack and Ping of Death. The goal of DoS attacks is not to steal information, but to disable a device or network on the Internet.

By default, the DoS feature is disabled. You need to enable it on the Switch and its port(s). See [Table 153 on page 199](#) for the types of DoS attacks that the Switch prevents when you turn on this feature. You cannot set the Switch to block a specific type of DoS attacks.

Note: DoS protection doesn't work on LACP-enabled ports.

### 30.5.1 The Global Screen

Use this screen to view the **Global** settings. Click **Configuration > Security > DoS > Global** to open this screen.

Figure 188 Configuration &gt; Security &gt; DoS &gt; Global

The following table describes the labels in this screen.

Table 150 Configuration &gt; Security &gt; DoS &gt; Global

LABEL	DESCRIPTION
Global	
State	Select the DoS security setting to be enabled or disabled.
Apply	Click <b>Apply</b> to save the changes.
Cancel	Click <b>Cancel</b> to discard the changes.

## 30.5.2 The Port Screen

Use this screen to view the **Port** settings. Click **Configuration > Security > DoS > Port** to open this screen.

Figure 189 Configuration &gt; Security &gt; DoS &gt; Port

Port	State
1	Disable
2	Disable
3	Disable
4	Disable
5	Disable
6	Disable
7	Disable
8	Disable
9	Disable
10	Disable
11	Disable
12	Disable
13	Disable
14	Disable
15	Disable
16	Disable
17	Disable
18	Disable
19	Disable
20	Disable
21	Disable
22	Disable
23	Disable
24	Disable
25	Disable
26	Disable

The following table describes the labels in this screen.

Table 151 Configuration &gt; Security &gt; DoS &gt; Port

LABEL	DESCRIPTION
Port	
Port	Displays the port index value.
State	Displays the port's DoS feature as <b>Enable</b> or <b>Disable</b> .

Table 151 Configuration &gt; Security &gt; DoS &gt; Port

LABEL	DESCRIPTION
Edit	Select this check box to configure the properties of a port. Click the <b>Edit</b> button change the properties of the port.
Cancel	Click <b>Cancel</b> to discard the changes.

### 30.5.3 The Port Edit Screen

Use this screen to configure the **Port** settings.

Click **Configuration > Security > DoS > Port > Edit** to open this screen.

Figure 190 Configuration &gt; Security &gt; DoS &gt; Port &gt; Edit

The following table describes the labels in this screen.

Table 152 Configuration &gt; Security &gt; DoS &gt; Port &gt; Edit

LABEL	DESCRIPTION
Port	
Port List	Displays the port index value.
State	Select <b>Enable</b> to activate the port's DoS feature.
Apply	Click <b>Apply</b> to save the changes.
Cancel	Click <b>Cancel</b> to discard the changes.

### 30.5.4 DoS Attack Types

The following table describes the types of DoS attacks that the Switch can prevent when you enable the DoS feature on the Switch and the port(s).

Table 153 DoS Attack Types

TYPE	PACKET TYPE	DESCRIPTION
DA_EQUAL_SA	Layer 2	These attacks result from sending a specially crafted packet to a machine where the source MAC address is the same as the destination MAC address. The system attempts to reply to itself, resulting in system lockup.
LAND	Layer 3 IPv4/IPv6	These attacks result from sending a specially crafted packet to a machine where the source host IPv4/IPv6 address is the same as the destination host IPv4/IPv6 address. The system attempts to reply to itself, resulting in system lockup.
UDP_BLAT / TCP_BLAT (Blat Attack)	Layer 3 IPv4/IPv6	These attacks result from sending a specially crafted packet to a machine where the source host UDP/TCP port is the same as the destination host UDP/TCP port. The system attempts to reply to itself, resulting in system lockup.

Table 153 DoS Attack Types (continued)

TYPE	PACKET TYPE	DESCRIPTION
PoD (Ping of Death)	Layer 3 IPv4/IPv6	Ping of Death uses a "ping" utility to create and send an IP packet that exceeds the maximum 65,536 bytes of data allowed by the IP specification. This may cause systems to crash, hang or reboot.
IPv6_FRAG_LEN_MIN	Layer 3 IPv6	This attack uses IPv6 fragmented packets (excluding the last one) whose payload length is less than 1240 bytes.
ICMP_FRAG_PKT	Layer 3 IPv4/IPv6	This attack uses many small fragmented ICMP packets.
ICMPv4_PING_MAX / ICMPv6_PING_MAX	Layer 3 IPv4/IPv6	This attack uses Ping packets whose length is larger than 512 bytes.
SMURF	Layer 3 IPv4	This attack uses Internet Control Message Protocol (ICMP) echo requests packets (pings) to cause network congestion or outages.
SYNchronization (SYN), ACKnowledgment (ACK) and FINish (FIN) packets are used to initiate, acknowledge and conclude TCP/IP communication sessions. The following scans exploit weaknesses in the TCP/IP specification and try to illicit a response from a host to identify ports for an attack:		
TCP_HDR_LEN_MIN	Layer 3 IPv4	TCP packets with header length less than 20 bytes.
SYN_SPORT_LESS_1024	Layer 3 IPv4/IPv6	TCP SYN packets with source port less than 1024.
NULL_SCAN (Scan Attack)	Layer 3 IPv4/IPv6	TCP sequence number is zero and all control bits are zeroes.
XMAS (Scan Attack)	Layer 3 IPv4/IPv6	TCP sequence number is zero and the FIN, URG and PSH bits are set.
SYN_FIN	Layer 3 IPv4/IPv6	SYN and FIN bits are set in the TCP packet.



# CHAPTER 31

## Configuration: AAA

### 31.1 Overview

This section provides information for **AAA** in **Configuration**.

Use the **AAA** screens to configure authentication, authorization and accounting settings on the Switch.

### 31.2 Auth Method

Authentication is the process of determining who a user is and validating access to the Switch. The Switch can authenticate users who try to log in based on user accounts configured on the Switch itself. The Switch can also use an external authentication server to authenticate a large number of users.

#### 31.2.1 The Auth Method Screen

Use this screen to view the **Auth Method** settings. Click **Configuration > AAA > Auth Method** to open this screen.

**Figure 191** Configuration > AAA > Auth Method

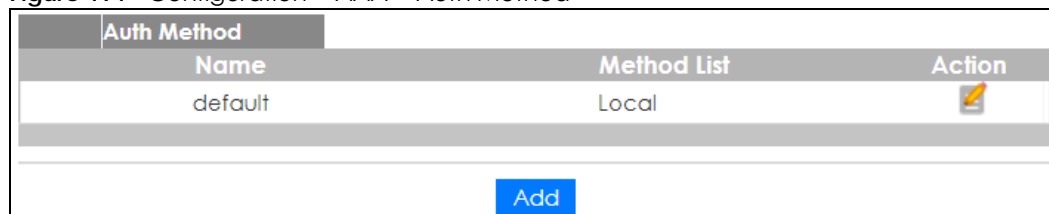

Name	Method List	Action
default	Local	

[Add](#)

The following table describes the labels in this screen.

Table 154 Configuration > AAA > Auth Method

LABEL	DESCRIPTION
Auth Method	
Name	Displays the authentication method name. The name can be between 1 and 31 ASCII Alphanumeric Characters.
Method List	Displays the list of authentication methods as being <b>Local</b> or <b>Radius</b> or <b>TACACS+</b> .
Action	Click the <b>Action</b> button to change the configuration settings for a VLAN entry.
Add	Click <b>Add</b> to create a new <b>Auth Method</b> entry.

## 31.2.2 The Auth Method Add/Edit Screen

Use this screen to configure the **Auth Method** settings. Click **Configuration > AAA > Auth Method > Add/Edit** to open this screen.

**Figure 192** Configuration > AAA > Auth Method > Add/Edit

The following table describes the labels in this screen.

Table 155 Configuration > AAA > Auth Method > Add/Modify

LABEL	DESCRIPTION
Auth Method	
Name	Enter the authentication method name. The name can be between 1 and 31 ASCII Alphanumeric Characters.
Method 1	Select the first authentication method as being <b>Local</b> , <b>Radius</b> , or <b>TACACS+</b> .
Method 2	Select the second authentication method as being <b>Empty</b> , <b>Local</b> , <b>Radius</b> , or <b>TACACS+</b> .
Method 3	Select the third authentication method as being <b>Empty</b> , <b>Local</b> , <b>Radius</b> , or <b>TACACS+</b> .
Apply	Click <b>Apply</b> to save the changes.
Cancel	Click <b>Cancel</b> to discard the changes.

## 31.3 RADIUS

### 31.3.1 The RADIUS Screen

Use this screen to configure the **RADIUS** settings. Click **Configuration > AAA > RADIUS** to open this screen.

**Figure 193** Configuration > AAA > RADIUS

The following table describes the labels in this screen.

Table 156 Configuration &gt; AAA &gt; RADIUS

LABEL	DESCRIPTION
RADIUS Servers	
Server	Displays the server name(s) as an IP address or a domain name.
Auth Port	Displays the authentication port number(s) as a value between 0 and 65535.
Key	Displays the authentication key.
Time out	Displays the number of time outs for replies. The value can be between 1 and 30 seconds.
Retries	Displays the number of retries. The value can be between 1 and 30.
Priority	Displays the server priority as <b>High</b> or <b>Low</b> .
Usage Type	Displays the server usage type as <b>Login</b> , <b>802.1X</b> , or <b>All</b> .
Action	
Edit	Click to <b>Edit</b> modify the entry.
Delete	Click <b>Delete</b> to delete the entry.
Add	Click <b>Add</b> to create a new <b>Server</b> entry.

### 31.3.2 The RADIUS Add/Edit Screen

Use this screen to configure the **RADIUS** settings. Click **Configuration > AAA > RADIUS > Add/Edit** to open this screen.

Figure 194 Configuration &gt; AAA &gt; RADIUS &gt; Add/Edit

RADIUS	
Server	( X.X.X.X or Hostname)
Authentication Port	1812 (0-65535)
Key String	(0 -63 ASCII Alphanumeric Characters Used )
Timeout for Reply	3 (1 - 30 sec)
Retries	3 (1 - 10)
Server Priority	<input checked="" type="radio"/> High <input type="radio"/> Low
Usage	<input type="radio"/> Login <input type="radio"/> 802.1X <input checked="" type="radio"/> All
<input type="button" value="Apply"/> <input type="button" value="Cancel"/>	

The following table describes the labels in this screen.

Table 157 Configuration &gt; AAA &gt; RADIUS &gt; Add/Modify

LABEL	DESCRIPTION
RADIUS	
Server	Enter the server name(s) as an IP address or a domain name.
Authentication Port	Enter the authentication port number(s) as a value between 0 and 65535.
Key String	Enter the authentication key string: 0 - 63 ASCII Alphanumeric Characters.
Timeout for Reply	Enter the number of time outs for replies. The value can be between 1 and 30 seconds.
Retries	Enter the number of retries. The value can be between 1 and 30.
Server Priority	Select the server priority as <b>High</b> or <b>Low</b> .

Table 157 Configuration &gt; AAA &gt; RADIUS &gt; Add/Modify (continued)

LABEL	DESCRIPTION
Usage	Select the server usage type as <b>Login</b> , <b>802.1X</b> , or <b>All</b> .
Apply	Click <b>Apply</b> to save the changes.
Cancel	Click <b>Cancel</b> to discard the changes.

## 31.4 TACACS+

### 31.4.1 The TACACS+ Screen

Use this screen to configure the **TACACS+** settings. Click **Configuration > AAA > TACACS+** to open this screen.

Figure 195 Configuration &gt; AAA &gt; TACACS+

TACACS+ Servers					
Server	Port	key	Timeout	Priority	Action
<input type="button" value="Add"/>					

The following table describes the labels in this screen.

Table 158 Configuration &gt; AAA &gt; TACACS+

LABEL	DESCRIPTION
TACACS+ Servers	
Server	Displays the server name(s) as an IP address or a domain name.
Port	Displays the port number(s) as a value between 0 and 65535.
Key	Displays the authentication key.
Timeout	Displays the number of time outs for replies. The value can be between 1 and 30 seconds.
Priority	Displays the priority as <b>High</b> or <b>Low</b> .
Action	
Edit	Click to <b>Edit</b> modify the entry.
Delete	Click <b>Delete</b> to delete the entry.
Add	Click <b>Add</b> to create a new <b>Server</b> entry.

### 31.4.2 The TACACS+ Add/Edit Screen

Use this screen to configure the **TACACS+** settings. Click **Configuration > AAA > TACACS+ > Add/Edit** to open this screen.

Figure 196 Configuration &gt; AAA &gt; TACACS+ &gt; Add/Edit

TACACS+		
Server	<input type="text"/>	(X.X.X.X or Hostname)
Port	49	(0-65535)
Key String	<input type="text"/>	(0 -63 ASCII Alphanumeric Characters Used )
Timeout for Reply	5	(1-30 sec)
Server Priority	<input checked="" type="radio"/> High <input type="radio"/> Low	
<input type="button" value="Apply"/> <input type="button" value="Cancel"/>		

The following table describes the labels in this screen.

Table 159 Configuration &gt; AAA &gt; TACACS+ &gt; Add/Modify

LABEL	DESCRIPTION
TACACS+	
Server	Enter the server name(s) as an IP address or a domain name.
Port	Enter the port number(s) as a value between 0 and 65535.
Key String	Enter the authentication key string: 0 - 63 ASCII alphanumeric characters.
Timeout for Reply	Enter the number of time outs for replies. The value can be between 1 and 30 seconds.
Server Priority	Select the server priority as <b>High</b> or <b>Low</b> .
Apply	Click <b>Apply</b> to save the changes.
Cancel	Click <b>Cancel</b> to discard the changes.

# CHAPTER 32

## Configuration: Management

### 32.1 Overview

This section provides information for **Management** in **Configuration**.

Use the **Management** screens to configure settings on the Switch. The following submenus are accessed from this section: **Syslog**, **SNMP**, **Error Disable**, **HTTP/HTTPS**, **Users**, **Remote Access Control**.

### 32.2 Syslog

The syslog feature can stores logs in the Switch's memory or sends logs to an external syslog server.

#### 32.2.1 The Global Screen

Use this screen to view and configure the **Global** settings. Click **Configuration > Management > Syslog > Global** to open this screen.

Figure 197 Configuration > Management > Syslog > Global

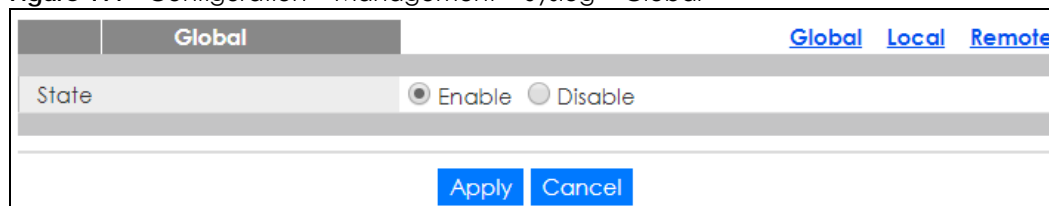

The following table describes the labels in this screen.

Table 160 Configuration > Management > Syslog > Global

LABEL	DESCRIPTION
Global	
State	Select <b>Enable</b> to turn on syslog (system logging) on the Switch. Otherwise, select <b>Disable</b> to turn it off.
Apply	Click <b>Apply</b> to save the changes.
Cancel	Click <b>Cancel</b> to discard the changes.

#### 32.2.2 The Local Screen

Use this screen to view the **Local** settings. Click **Configuration > Management > Syslog > Local** to open this screen.

Figure 198 Configuration &gt; Management &gt; Syslog &gt; Local

Local	Global	Local	Remote
Target	Severity	Action	
Buffered	notice	[Edit] [Delete]	
[Add]			

The following table describes the labels in this screen.

Table 161 Configuration &gt; Management &gt; Syslog &gt; Local

LABEL	DESCRIPTION
Local	
Target	Displays the local storage target for logging messages. It shows whether the logs are stored in the Switch's run-time memory buffer or flash (permanent) memory. If the logs are stored in the Switch's memory buffer, the logs will be erased when the Switch reboots.
Severity	Displays the severity level of messages to be stored in the Switch's memory. The Switch stores the messages of that severity level or higher.
Action	
Edit	Click <b>Edit</b> to make changes to the entry.
Delete	Click <b>Delete</b> to remove the entry.
Add	Click <b>Add</b> to create a new <b>Local</b> entry.

### 32.2.3 The Local Add/Edit Screen

Use this screen to configure the **Local** settings. Click **Configuration > Management > Syslog > Local > Add/Edit** to open this screen.

Figure 199 Configuration &gt; Management &gt; Syslog &gt; Local &gt; Add/Edit

Local	Global	Local	Remote
Target	<input checked="" type="radio"/> Buffered <input type="radio"/> Flash		
Severity	emerg ▼		
[Apply] [Cancel]			

The following table describes the labels in this screen.

Table 162 Configuration &gt; Management &gt; Syslog &gt; Local &gt; Add/Modify

LABEL	DESCRIPTION
Local	
Target	Select the local storage target for logging messages. The options are <b>Buffered</b> or <b>Flash</b> .
Severity	Select the severity level of the messages that you want to save in the Switch's memory. The Switch stores the logging messages with the severity level equal to or higher than what you selected. For example, if you select <b>warning</b> , all messages with the <b>warning</b> , <b>error</b> , <b>crit</b> , <b>alert</b> or <b>emerg</b> severity level will be stored.

Table 162 Configuration &gt; Management &gt; Syslog &gt; Local &gt; Add/Modify (continued)

LABEL	DESCRIPTION
Apply	Click <b>Apply</b> to save the changes.
Cancel	Click <b>Cancel</b> to discard the changes.

## 32.2.4 The Remote Screen

Use this screen to view the **Remote** settings. Click **Configuration > Management > Syslog > Remote** to open this screen.

Figure 200 Configuration &gt; Management &gt; Syslog &gt; Remote

The following table describes the labels in this screen.

Table 163 Configuration &gt; Management &gt; Syslog &gt; Remote

LABEL	DESCRIPTION
Remote	
Server	Displays the external syslog server information which includes the server IP address and port number.
Severity	Displays the severity level of messages to be sent to the syslog server. The Switch sends the messages of that severity level or higher.
Facility	Displays the facility designation of the remote entry.
Action	
Edit	Click <b>Edit</b> to make changes to the entry.
Delete	Click <b>Delete</b> to remove the entry.
Add	Click <b>Add</b> to create a new <b>Remote</b> entry.

## 32.2.5 The Remote Add/Edit Screen

Use this screen to add an external syslog server. Click **Configuration > Management > Syslog > Remote > Add/Edit** to open this screen.

Figure 201 Configuration &gt; Management &gt; Syslog &gt; Remote &gt; Add/Edit



The following table describes the labels in this screen.

Table 164 Configuration > Management > Syslog > Remote > Add/Edit

LABEL	DESCRIPTION
Remote	
Server	Enter the IP address or domain name of the syslog server.
Server Port	Enter port number of the syslog server.
Severity	Select the severity level of the messages that you want the Switch to send to this syslog server. The Switch sends the logging messages with the severity level equal to or higher than what you selected. For example, if you select <b>warning</b> , all messages with the <b>warning</b> , <b>error</b> , <b>crit</b> , <b>alert</b> or <b>emerg</b> severity level will be sent.
Facility	Select the log facility from the dropdown list. The log facility allows you to send logs to different files in the syslog server. Refer to the documentation of your syslog program for more details.
Apply	Click <b>Apply</b> to save the changes.
Cancel	Click <b>Cancel</b> to discard the changes.

## 32.3 SNMP

Simple Network Management Protocol (SNMP) is an application layer protocol used to manage and monitor TCP/IP-based devices. SNMP is used to exchange management information between the network management system (NMS) and a network element (NE). A manager station can manage and monitor the Switch through the network via SNMP version 1 (SNMPv1), SNMP version 2c or SNMP version 3.

### 32.3.1 The Global Screen

Use this screen to view and configure the **Global** settings. Click **Configuration > Management > SNMP > Global** to open this screen.

Figure 202 Configuration > Management > SNMP > Global

The following table describes the labels in this screen.

Table 165 Configuration > Management > SNMP > Global

LABEL	DESCRIPTION
Global	
State	Select the global SNMP setting to be enabled or disabled.
Apply	Click <b>Apply</b> to save the changes.
Cancel	Click <b>Cancel</b> to discard the changes.

### 32.3.2 The Community Screen

Use this screen to view the **Community** settings. Click **Configuration > Management > SNMP > Community** to open this screen.

**Figure 203** Configuration > Management > SNMP > Community

Community		
Community Name	Access Right	Action
public	Read-Write	

[Add](#)

The following table describes the labels in this screen.

**Table 166** Configuration > Management > SNMP > Community

LABEL	DESCRIPTION
Community	
Community Name	Displays a string identifying the community name that this entry should belong to. The allowed string length is 1 to 20, and the allowed content is ASCII characters from 33 to 126.
Access Right	Displays the access mode for this entry. The possible values are <b>Read-Only</b> and <b>Read-Write</b> .
Action	
Delete	Click <b>Delete</b> to remove the entry.
Add	Click <b>Add</b> to create a new <b>SNMP Community</b> entry.

### 32.3.3 The Community Add Screen

Use this screen to configure the **Community** settings. Click **Configuration > Management > SNMP > Community > Add** to open this screen.

**Figure 204** Configuration > Management > SNMP > Community > Add

Community	
Community Name	Access Right
<input type="text"/>	<input checked="" type="radio"/> Read-Only <input type="radio"/> Read-Write

[Apply](#) [Cancel](#)

The following table describes the labels in this screen.

**Table 167** Configuration > Management > SNMP > Community > Add

LABEL	DESCRIPTION
Community	
Community Name	Enter a string identifying the community name that this entry should belong to. The allowed string length is 1 to 20, and the allowed content is ASCII characters from 33 to 126.
Access Right	Select the access mode for this entry. The possible values are <b>Read-Only</b> and <b>Read-Write</b> .

Table 167 Configuration &gt; Management &gt; SNMP &gt; Community &gt; Add (continued)

LABEL	DESCRIPTION
Apply	Click <b>Apply</b> to save the changes.
Cancel	Click <b>Cancel</b> to discard the changes.

### 32.3.4 The Group Screen

Use this screen to view the **Group** settings. Click **Configuration > Management > SNMP > Group** to open this screen.

Figure 205 Configuration &gt; Management &gt; SNMP &gt; Group

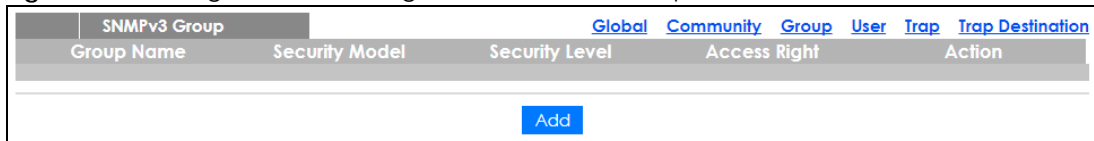

The following table describes the labels in this screen.

Table 168 Configuration &gt; Management &gt; SNMP &gt; Group

LABEL	DESCRIPTION
SNMPv3 Group	
Group Name	Displays a string identifying the group name that this entry should belong to. The allowed string length is 1 to 30, and the allowed content is ASCII characters from 33 to 126.
Security Model	Displays the security model that this entry belongs to. Possible security models are: <ul style="list-style-type: none"> <li><b>any</b>: Any security model accepted(v1   v2c   usm).</li> <li><b>v1</b>: Reserved for SNMPv1.</li> <li><b>v2c</b>: Reserved for SNMPv2c.</li> <li><b>usm</b>: User-based Security Model (USM).</li> </ul>
Security Level	Displays the security model that this entry belongs to. Possible security models are: <ul style="list-style-type: none"> <li><b>noauth</b>: No authentication and no privacy.</li> <li><b>auth</b>: Authentication and no privacy.</li> <li><b>Priv</b>: Authentication and privacy.</li> </ul>
Access Right	Displays the access mode for this entry. The possible values are <b>Read Only</b> and <b>Read-Write</b> .
Action	
Delete	Click <b>Delete</b> to remove the entry.
Add	Click <b>Add</b> to create a new <b>SNMPv3 Group</b> entry.

### 32.3.5 The Group Add Screen

Use this screen to configure the **Group** settings. Click **Configuration > Management > SNMP > Group > Add** to open this screen.

**Figure 206** Configuration > Management > SNMP > Group > Add

The following table describes the labels in this screen.

**Table 169** Configuration > Management > SNMP > Group > Add

LABEL	DESCRIPTION
SNMPv3 Group	
Group Name	Enter a string identifying the group name that this entry should belong to. The allowed string length is 1 to 30, and the allowed content is ASCII characters from 33 to 126.
Security Level	Select the security model that this entry belongs to. Possible security models are: <ul style="list-style-type: none"> <li>• <b>noauth</b>: No authentication and no privacy.</li> <li>• <b>auth</b>: Authentication and no privacy.</li> <li>• <b>priv</b>: Authentication and privacy.</li> </ul>
Access Mode	Select the access mode for this entry. The possible values are <b>Read-Only</b> and <b>Read-Write</b> .
Apply	Click <b>Apply</b> to save the changes.
Cancel	Click <b>Cancel</b> to discard the changes.

### 32.3.6 The User Screen

Use this screen to view the **User** settings. Click **Configuration > Management > SNMP > User** to open this screen.

**Figure 207** Configuration > Management > SNMP > User

The following table describes the labels in this screen.

**Table 170** Configuration > Management > SNMP > User

LABEL	DESCRIPTION
SNMP User	
User Name	Displays a string identifying the user name that this entry belongs to. The allowed string length is 1 to 30, and the allowed content is ASCII characters from 33 to 126.
Group	Displays a string identifying the group name that this entry belongs to. The allowed string length is 1 to 30, and the allowed content is ASCII characters from 33 to 126.
Privilege Mode	Displays the privilege mode that this entry belongs to.

Table 170 Configuration &gt; Management &gt; SNMP &gt; User (continued)

LABEL	DESCRIPTION
Authentication Protocol	Displays the authentication protocol that this entry belongs to. Possible authentication protocols are: <ul style="list-style-type: none"> <li><b>None:</b> No authentication protocol.</li> <li><b>MD5:</b> An optional flag to indicate that this user uses MD5 authentication protocol.</li> <li><b>SHA:</b> An optional flag to indicate that this user uses SHA authentication protocol.</li> </ul> The value of the security level cannot be modified if the entry already exists. That means you must first ensure that the value is set correctly.
Encryption Protocol	Displays the encryption protocol that this entry belongs to.
Access Right	Displays the access mode for this entry. The possible values are <b>Read-Only</b> and <b>Read-Write</b> .
Action	
Delete	Click <b>Delete</b> to remove the entry.
Add	Click <b>Add</b> to create a new SNMP user.

### 32.3.7 The User Add Screen

Use this screen to configure the **User** settings. Click **Configuration > Management > SNMP > User > Add** to open this screen.

Figure 208 Configuration &gt; Management &gt; SNMP &gt; User &gt; Add/

The following table describes the labels in this screen.

Table 171 Configuration &gt; Management &gt; SNMP &gt; User &gt; Add

LABEL	DESCRIPTION
SNMP User	
User Name	Enter a string identifying the user name that this entry belongs to. The allowed string length is 1 to 30, and the allowed content is ASCII characters from 33 to 126.
Group Name	Enter a string identifying the group name that this entry belongs to. The allowed string length is 1 to 30, and the allowed content is ASCII characters from 33 to 126.
Auth Protocol	Select the authentication protocol that this entry belongs to. Possible authentication protocols are: <ul style="list-style-type: none"> <li><b>MD5:</b> An optional flag to indicate that this user uses MD5 authentication protocol.</li> <li><b>SHA:</b> An optional flag to indicate that this user uses SHA authentication protocol.</li> </ul> The value of the security level cannot be modified if the entry already exists. That means you must first ensure that the value is set correctly.

Table 171 Configuration &gt; Management &gt; SNMP &gt; User &gt; Add (continued)

LABEL	DESCRIPTION
Auth Password	Enter a string identifying the authentication password phrase. For MD5 authentication protocol, the allowed string length is 8 to 32. For SHA authentication protocol, the allowed string length is 8 to 32. The allowed content is ASCII characters from 33 to 126.
Priv password	Enter a string identifying the privacy password phrase. The allowed string length is 8 to 64 and the allowed content is ASCII characters from 33 to 126.
Apply	Click <b>Apply</b> to save the changes.
Cancel	Click <b>Cancel</b> to discard the changes.

### 32.3.8 The Trap Screen

Use this screen to configure the **Trap** settings. Click **Configuration > Management > SNMP > Trap** to open this screen.

Figure 209 Configuration &gt; Management &gt; SNMP &gt; Trap

SNMP Trap	Global	Community	Group	User	Trap	Trap Destination
SNMP Authfailure Trap State	<input checked="" type="radio"/> Enable	<input type="radio"/> Disable				
SNMP LinkupDown Trap State	<input checked="" type="radio"/> Enable	<input type="radio"/> Disable				
SNMP Warm-Start Trap State	<input checked="" type="radio"/> Enable	<input type="radio"/> Disable				
SNMP Cold-Start Trap State	<input checked="" type="radio"/> Enable	<input type="radio"/> Disable				

The following table describes the labels in this screen.

Table 172 Configuration &gt; Management &gt; SNMP &gt; Trap

LABEL	DESCRIPTION
SNMP Trap	
SNMP Authfailure Trap State	Select the SNMP entity is permitted to generate authentication failure traps. Possible modes are: <ul style="list-style-type: none"> <li>• <b>Enabled:</b> Enable SNMP trap authentication failure.</li> <li>• <b>Disabled:</b> Disable SNMP trap authentication failure.</li> </ul>
SNMP LinkupDown Trap State	Select the SNMP trap link-up and link-down mode operation. Possible modes are: <ul style="list-style-type: none"> <li>• <b>Enabled:</b> Enable SNMP trap link-up and link-down mode operation.</li> <li>• <b>Disabled:</b> Disable SNMP trap link-up and link-down mode operation.</li> </ul>
SNMP Warm-Start Trap State	Reboot using software or hardware button reboot.
SNMP Cold-Start Trap State	Reboot though power off.
Apply	Click <b>Apply</b> to save the changes.
Cancel	Click <b>Cancel</b> to discard the changes.

### 32.3.9 The Trap Destination Screen

Use this screen to view the **Trap Destination** settings. Click **Configuration > Management > SNMP > Trap Destination** to open this screen.

**Figure 210** Configuration > Management > SNMP > Trap Destination

SNMP Trap Host		<a href="#">Global</a>	<a href="#">Community</a>	<a href="#">Group</a>	<a href="#">User</a>	<a href="#">Trap</a>	<a href="#">Trap Destination</a>
Server	Version	Community/User Name		UDP Port		Action	
<input type="button" value="Add"/>							

The following table describes the labels in this screen.

**Table 173** Configuration > Management > SNMP > Trap Destination

LABEL	DESCRIPTION
SNMP Trap Host	
Server	Displays a string identifying the server address that this entry belongs to.
Version	Indicates the SNMP trap supported version. Possible versions are: <ul style="list-style-type: none"> <li><b>v1:</b> Set SNMP trap supported version 1.</li> <li><b>v2c:</b> Set SNMP trap supported version 2c.</li> <li><b>v3:</b> Set SNMP trap supported version 3.</li> </ul>
Community/User Name	Displays the community / user name that this entry belongs to.
UDP Port	Displays the trap use destination for the UDP port.
Action	
Delete	Click <b>Delete</b> to remove the entry.
Add	Click <b>Add</b> to create a new <b>SNMP Trap Host</b> entry.

### 32.3.10 The Trap Destination Add Screen

Use this screen to configure the **Trap Destination** settings. Click **Configuration > Management > SNMP > Trap Destination > Add** to open this screen.

**Figure 211** Configuration > Management > SNMP > Trap Destination > Add

Trap Destination		<a href="#">Global</a>	<a href="#">Community</a>	<a href="#">Group</a>	<a href="#">User</a>	<a href="#">Trap</a>	<a href="#">Trap Destination</a>
Server	<input type="text" value=""/>	(X.X.X.X or Hostname)					
Version	<input checked="" type="radio"/> v1 <input type="radio"/> v2c <input type="radio"/> v3						
Community Name	<input type="text" value="public"/>	▼					
User Name	<input type="text" value=""/>	▼					
UDP Port	<input type="text" value="162"/>	<input type="text" value="(1 -65535)"/>					
<input type="button" value="Apply"/> <input type="button" value="Cancel"/>							

The following table describes the labels in this screen.

**Table 174** Configuration > Management > SNMP > Trap Destination > Add

LABEL	DESCRIPTION
Trap Destination	
Server	Enter the IP address of the server or a string identifying the server address that this entry belongs to.

Table 174 Configuration &gt; Management &gt; SNMP &gt; Trap Destination &gt; Add (continued)

LABEL	DESCRIPTION
Version	Select the SNMP trap supported version. Possible versions are: <ul style="list-style-type: none"> <li><b>v1</b>: Set SNMP trap supported version 1.</li> <li><b>v2c</b>: Set SNMP trap supported version 2c.</li> <li><b>v3</b>: Set SNMP trap supported version 3.</li> </ul>
Community Name	Displays the community name that this entry belongs to.
User Name	Displays the user name that this entry belongs to.
UDP Port	Enter a UDP port for this entry.
Apply	Click <b>Apply</b> to save the changes.
Cancel	Click <b>Cancel</b> to discard the changes.

## 32.4 Error Disable

### 32.4.1 The Error Disabled Screen

Use this screen to configure the **Error Disabled** settings. Click **Configuration > Management > Error Disable** to open this screen.

Figure 212 Configuration &gt; Management &gt; Error Disable

Error Disable	
Recovery Interval	300 (0-86400 sec)
Broadcast Flood	<input type="radio"/> Enable <input checked="" type="radio"/> Disable
Unknown Multicast Flood	<input type="radio"/> Enable <input checked="" type="radio"/> Disable
Unicast Flood	<input type="radio"/> Enable <input checked="" type="radio"/> Disable
Port Security	<input type="radio"/> Enable <input checked="" type="radio"/> Disable
<input type="button" value="Apply"/> <input type="button" value="Cancel"/>	

The following table describes the labels in this screen.

Table 175 Configuration &gt; Management &gt; Error Disable

LABEL	DESCRIPTION
Error Disable	
Recovery Interval	Enter the recovery interval value.
Broadcast Flood	Select an option to <b>Enable</b> or <b>Disable</b> the Broadcast Flood.
Unknown Multicast Flood	Select an option to <b>Enable</b> or <b>Disable</b> the Unknown Multicast Flood.
Unicast Flood	Select an option to <b>Enable</b> or <b>Disable</b> the Unicast Flood.
Port Security	Select an option to <b>Enable</b> or <b>Disable</b> the Port Security.
POE Inline Power	Select an option to <b>Enable</b> or <b>Disable</b> the POE Inline Power.



Table 175 Configuration &gt; Management &gt; Error Disable

LABEL	DESCRIPTION
Apply	Click <b>Apply</b> to save the changes.
Cancel	Click <b>Cancel</b> to discard the changes.

## 32.5 HTTP/HTTPS

### 32.5.1 The HTTP Screen

Use this screen to configure the **HTTP** settings. Click **Configuration > Management > HTTP/HTTPS > HTTP** to open this screen.

Figure 213 Configuration &gt; Management &gt; HTTP/HTTPS &gt; HTTP

The following table describes the labels in this screen.

Table 176 Configuration &gt; Management &gt; HTTP/HTTPS &gt; HTTP

LABEL	DESCRIPTION
HTTP	
State	Select the HTTP mode operation. Possible modes are: <ul style="list-style-type: none"> <li>• <b>Enabled:</b> Enable HTTP mode operation.</li> <li>• <b>Disabled:</b> Disable HTTP mode operation.</li> </ul>
Authentication Method	Select the authentication method from the dropdown list.
Session Timeout	Enter the session timeout value. The timeout can be between 0 and 86400 minutes.
Apply	Click <b>Apply</b> to save the changes.
Cancel	Click <b>Cancel</b> to discard the changes.

### 32.5.2 The HTTPS Screen

Use this screen to configure the **HTTPS** settings. Click **Configuration > Management > HTTP/HTTPS > HTTPS** to open this screen.

Figure 214 Configuration &gt; Management &gt; HTTP/HTTPS &gt; HTTPS

HTTPS		<a href="#">HTTP</a>	<a href="#">HTTPS</a>
State	Enable		
Authentication Method	default ▼		
Session Timeout	3	(0-86400 min)	
<input type="button" value="Apply"/> <input type="button" value="Cancel"/>			

The following table describes the labels in this screen.

Table 177 Configuration &gt; Management &gt; HTTP/HTTPS &gt; HTTPS

LABEL	DESCRIPTION
HTTPS	
State	Select the HTTPS mode operation. Possible modes are: <ul style="list-style-type: none"> <li>• <b>Enable</b>: Enable HTTPS mode operation.</li> </ul>
Authentication Method	Select the authentication method from the dropdown list.
Session Timeout	Enter the session timeout value. The timeout can be between 0 and 86400 minutes.
Apply	Click <b>Apply</b> to save the changes.
Cancel	Click <b>Cancel</b> to discard the changes.

## 32.6 Users

### 32.6.1 The Users Screen

Use this screen to configure the **Users** settings. Click **Configuration > Management > Users** to open this screen.

Figure 215 Configuration &gt; Management &gt; Users

Users			
User	Password	Privilege Level	Action
admin	*****	Admin	
<input type="button" value="Add"/>			

The following table describes the labels in this screen.

Table 178 Configuration &gt; Management &gt; Users

LABEL	DESCRIPTION
Users	
User	A string identifying the user name that this entry should belong to. The allowed string length is 1 to 32. The valid user name is a combination of letters, numbers and underscores.

Table 178 Configuration &gt; Management &gt; Users (continued)

LABEL	DESCRIPTION
Password	Displays the password of the user. The allowed string length is 0 to 32.
Privilege Level	Displays the privilege level of the user, range: admin and user.
Action	
Edit	Click <b>Edit</b> to make changes to the entry.
Delete	Click <b>Delete</b> to remove the entry.
Add	Click <b>Add</b> to create a new <b>User</b> entry.

## 32.6.2 The Users Add/Edit Screen

Use this screen to configure the **Users** settings. Click **Configuration > Management > Users > Add/Edit** to open this screen.

Figure 216 Configuration &gt; Management &gt; Users &gt; Add/Edit

The following table describes the labels in this screen.

Table 179 Configuration &gt; Management &gt; Users &gt; Add/Edit

LABEL	DESCRIPTION
Users	
User	Enter a string identifying the user name that this entry should belong to. The allowed string length is 1 to 32. The valid user name is a combination of letters, numbers and underscores.
Encryption	Select the encryption type. The values can be <b>Clear Text</b> , <b>Encrypted</b> , and <b>No Password</b> .
Password	Enter a password for the user. The allowed string length is 0 to 32.
Password Confirm	Enter the same password again to confirm.
Privilege Level	Select the privilege level of the user range: admin and user.
Apply	Click <b>Apply</b> to save the changes.
Cancel	Click <b>Cancel</b> to discard the changes.

## 32.7 Remote Access Control

### 32.7.1 The Global Screen

Use this screen to configure the **Global** settings. Click **Configuration > Management > Remote Access Control > Global** to open this screen.

**Figure 217** Configuration > Management > Remote Access Control > Global

The following table describes the labels in this screen.

**Table 180** Configuration > Management > Remote Access Control > Global

LABEL	DESCRIPTION
Global	
State	Select the global remote access setting to be enabled or disabled.
Apply	Click <b>Apply</b> to save the changes.
Cancel	Click <b>Cancel</b> to discard the changes.
Profile	
No.	Displays the priority level of the entry. The value can be between 1 and 16.
Action	Displays the action value. The values are <b>Permit</b> or <b>Deny</b> .
Source IP	Display the source IP value.
Source IP Mask	Displays the source IP mask.
Port	Display the port value.
Service	Display the service used for remote access. The values are <b>ALL</b> , <b>HTTP</b> , <b>HTTPS</b> , or <b>SNMP</b> .
Action	
Edit	Click <b>Edit</b> to make changes to the entry.
Delete	Click <b>Delete</b> to remove the entry.
Add	Click <b>Add</b> to create a new profile entry.

### 32.7.2 The Profile Add/Edit Screen

Use this screen to configure the **Profile** settings. Click **Configuration > Management > Remote Access Control > Global > Add/Edit** to open this screen.

**Figure 218** Configuration > Management > Remote Access Control > Global > Add/Edit

The screenshot shows the 'Management Access List' configuration interface. It includes a title bar, a list of entries (No. 1), an Action dropdown (Permit selected), a Port section with Available and Acting columns, a Source dropdown (ALL selected), and an IPv4/Mask field (0.0.0.0 / 0.0.0.0). A Service dropdown (ALL selected) is also present. At the bottom, there are 'Apply' and 'Cancel' buttons.

The following table describes the labels in this screen.

**Table 181** Configuration > Management > Remote Access Control > Global > Add/Edit

LABEL	DESCRIPTION
Management Access List	
No.	Enter the priority level of the entry. The value can be between 1 and 16.
Action	Select the action value. The values are <b>Permit</b> or <b>Deny</b> .
Port	Select a value in <b>Available</b> and click the <b>Add</b> (>) icon to transfer to the Acting column. Select a value in <b>Acting</b> and click the <b>Remove</b> (<) icon to transfer to the Available column.
Source	Select the source IP value. The options are <b>ALL</b> or <b>IPv4/Mask</b> .
IPv4/Mask	Select and enter the IPv4 address and subnet mask of a computer which will be allowed or denied to access the Switch.
Service	Select the service to use for remote access. The values are <b>ALL</b> , <b>HTTP</b> , <b>HTTPS</b> , or <b>SNMP</b> .
Apply	Click <b>Apply</b> to save the changes.
Cancel	Click <b>Cancel</b> to discard the changes.

# CHAPTER 33

## Maintenance

### 33.1 Firmware Upgrade

#### 33.1.1 Overview

Firmware updates contain bug fixes and fixes for security vulnerabilities. It is recommended to keep the Switch's firmware up to date. You can upgrade the Switch's firmware manually using a file downloaded on your computer or through the online web configurator.

Note: Be sure to upload the correct model firmware as uploading the wrong model firmware may damage your device.

From the **Maintenance** screen, display the **Upload** screen as shown next. Use this screen to upgrade the Switch's firmware.

Figure 219 Maintenance > Firmware > Upload

Upload		<a href="#">Upload</a> <a href="#">Management</a>
Method	<input checked="" type="radio"/> TFTP <input type="radio"/> HTTP	
Server IP	<input type="text"/>	(IPv4 or IPv6 Address)
File Name	<input type="text"/>	
Image	<input type="radio"/> Active <input checked="" type="radio"/> Backup	
File Path	<input type="text"/> <input type="button" value="Browse"/>	
<input type="button" value="Apply"/> <input type="button" value="Cancel"/>		

The following table describes the labels under **Upload**.

Table 182 Maintenance > Firmware > Upload

LABEL	DESCRIPTION
Upload	
Method	Choose <b>HTTP</b> to use the web configurator for the firmware upload. Alternatively, choose <b>TFTP</b> to download the firmware from a TFTP server.
Server IP	To download from a TFTP server, enter the TFTP server IP address.
File Name	Enter the name of the firmware file on the TFTP server.
Image	Choose <b>Backup</b> to upload the firmware file as the backup image. Alternatively, choose <b>Active</b> to upload the firmware file as the active image.
File Path	Browse to the path on your computer to upload the firmware you want as the active image.

### 33.1.2 Upgrade the firmware from a file on a server

Follow the steps below to upgrade the firmware from a TFTP server.

1. In **Method**, choose **TFTP**.
2. In **Server IP**, enter the TFTP server IP address.
3. In **File Name**, enter the name of the firmware file on the TFTP server.
4. In **Image**, choose **Backup** to upload the firmware file as the backup image.  
OR  
Choose **Active** to upload the firmware file as the active image.
5. Click **Apply** to upgrade the chosen image.  
OR  
Click **Cancel** to discard the changes.

After the firmware upgrade process is complete, see the **System Info** screen to verify your current firmware version number.

### 33.1.3 Upgrade the firmware from a file on your computer

Note: For manual upgrade, make sure you have downloaded (and unzipped) the correct model firmware and version to your computer before uploading it to the device. The file name should have a .bix extension.

Follow the steps below to upgrade the firmware from a file on your computer.

1. In **Method**, choose **HTTP**.
2. In **Image**, choose **Active** to upload the firmware file on the active partition image.  
OR  
Choose **Backup** to upload the firmware file on the backup partition image.
3. In **File Path**, click **Browse** to display the **Choose File** screen from which you can locate the firmware file in the bix format on your computer.
4. Click **Apply** to upload the chosen file.  
OR  
Click **Cancel** to discard the changes.

After the firmware upgrade process is complete, see the **System Info** screen to verify your current firmware version number.

## 33.2 Firmware Management

### 33.2.1 Overview

The Firmware Management screen provides instant access to the firmware versions installed on your Switch. Active and backup firmware versions are saved as images on flash partitions. The backup image is used when the active partition has problems during boot.

From the **Maintenance** screen, display the **Firmware Management** screen as shown next. Use this screen to view image information and activate an image.

Figure 220 Maintenance &gt; Firmware &gt; Management

The following table describes the labels shown under **Images Information**.

Table 183 Maintenance &gt; Firmware &gt; Management

LABEL	DESCRIPTION
Image Select	
Active Image	Select which firmware should load, click <b>Apply</b> and reboot the Switch to see changes.
Apply	Click <b>Apply</b> to save the changes.
Cancel	Click <b>Cancel</b> to discard the changes.
Images Information	
Flash Partition	Displays the partition number.
Image Size	Displays the size of the partition image in bytes.
Created Time	Displays the date and time when the image was created in the Coordinated Universal Time (UTC) format.

### 33.2.2 Select the Active Image

The available partition is shown under **Image Select**.

Follow the steps below to choose the active image, which will be the default partition during boot. When you selected the active image and saved the changes, the other one will be the backup.

If you are facing problems with the active partition when booting, the Switch will use the backup one and it'll be loaded automatically.

1. In **Active Image**, choose the backup image according to the information displayed in **Images Information**.
2. Click **Apply** to activate the backup image.  
OR  
Click **Cancel** to discard the changes.



## 33.3 Backup a Configuration File

### 33.3.1 Overview

You can save various "snapshots" of your device to the server or your computer and restore them at a later date, if required.

Click **Maintenance > Configuration > Backup** to display the screen as shown next. Use this screen to back up your current Switch configuration and log files to a server or as local files to your computer.

**Figure 221** Maintenance > Configuration > Backup

The following table describes the labels under **Backup**.

Table 184 Maintenance > Configuration > Backup

LABEL	DESCRIPTION
Backup	
Method	Choose <b>HTTP</b> to use the web configurator to backup the configuration. Alternatively, choose <b>TFTP</b> to upload the snapshot to a TFTP server.
Server IP	To upload the backup to a TFTP server, enter the TFTP server IP address.
Content	<p>Choose the type of file for backup. You can back up configuration files (running, startup, or backup) or log files (flash or buffer).</p> <p>There are three different types of configuration files:</p> <p><b>Backup configuration</b> - this is saved in the Switch. If you make changes to the current configuration, and there are problems, you can revert to the Backup configuration without having to restore a new file.</p> <p><b>Startup configuration</b> - this is the configuration used when the Switch is booting up.</p> <p><b>Running configuration</b> - this is the configuration when the Switch is running.</p> <p>There are two different types of log files:</p> <p><b>Flash log:</b> Select this to save logs in the Switch's flash (permanent) memory.</p> <p><b>Buffer log:</b> Select this to save logs in the Switch's memory buffer. If the logs are stored in the Switch's memory buffer, the logs will be erased when the Switch reboots.</p>
Apply	Click <b>Apply</b> to save the changes.
Cancel	Click <b>Cancel</b> to discard the changes.

### 33.3.2 Back up configuration or log files to a server

Follow the steps below to backup configuration or log files to a TFTP server.

1. In **Method**, choose **TFTP**.
2. In **Server IP**, enter the TFTP server IP address.
3. In **Content**, choose any one file type.
4. Click **Apply** to save a snapshot of your current configuration to the TFTP server.  
OR  
Click **Cancel** to discard the changes.

### 33.3.3 Back up configuration or log files to your computer

Follow the steps below to backup configuration or log files to your computer.

1. In **Method**, choose **HTTP**.
2. In **Content**, choose any one file type.
3. Click **Apply** to display the **Save File** screen from which you can save the configuration file in the cfg format or the log file in the log format to your computer.  
OR  
Click **Cancel** to discard the changes.

## 33.4 Restore a Configuration File

### 33.4.1 Overview

You can restore a previously saved device configuration from the server or your computer.

Click **Maintenance > Configuration > Restore** to display the screen as shown next. Use this screen to restore a previously saved configuration from a server or your computer.

**Figure 222** Maintenance > Configuration > Restore

The following table describes the labels under **Configuration Restore**.

**Table 185** Maintenance > Configuration > Restore

LABEL	DESCRIPTION
Configuration Restore	
Method	Choose <b>HTTP</b> to use the web configurator for restoring the configuration file. Alternatively, choose <b>TFTP</b> to download the snapshot from a TFTP server.
Server IP	To download from a TFTP server, enter the TFTP server IP address.

Table 185 Maintenance &gt; Configuration &gt; Restore

LABEL	DESCRIPTION
File Name	Enter the name of the configuration file on the TFTP server.
File Path	Browse to the path on your computer to upload the configuration you want to restore.
Apply	Click <b>Apply</b> to save the changes.
Cancel	Click <b>Cancel</b> to discard the changes.

### 33.4.2 Restore the configuration from a file on a server

Follow the steps below to restore the configuration from a server.

1. In **Method**, choose **TFTP**.
2. In **Server IP**, enter the TFTP server IP address.
3. In **File Name**, enter the name of the configuration file on the TFTP server.
4. Click **Apply** to restore to the chosen file as the running configuration.  
OR  
Click **Cancel** to discard the changes.

### 33.4.3 Restore the configuration from a file on your computer

Follow the steps below to restore the configuration from a file on your computer.

1. In **Method**, choose **HTTP**.
2. In **File Path**, click **Browse** to display the **Choose File** screen from which you can locate the configuration file in the cfg format on your computer.
3. Click **Apply** to restore to the chosen file as the running configuration.  
OR  
Click **Cancel** to discard the changes.

## 33.5 Manage Configuration Files

### 33.5.1 Overview

The Configuration Management screen provides instant access to the configuration files of your Switch. You can overwrite the startup and backup configurations with the current running, startup, or backup configuration file.

Click **Maintenance > Configuration > Management** to display the screen as shown next. Use this screen to replace startup and backup configuration files.

Figure 223 Maintenance &gt; Configuration &gt; Management

File Management		<a href="#">Backup</a>	<a href="#">Restore</a>	<a href="#">Management</a>	<a href="#">Factory Default</a>
Source File	<input checked="" type="radio"/> Running configuration <input type="radio"/> Startup configuration <input type="radio"/> Backup configuration				
Destination File	<input checked="" type="radio"/> Startup configuration <input type="radio"/> Backup configuration				
		<a href="#">Apply</a>	<a href="#">Cancel</a>		

Follow the steps to overwrite the startup or backup configuration file.

1. In **Source File**, select the file to be used as a reference.
2. In **Destination File**, select the file to be overwritten.
3. Click **Apply** to restore to overwrite the destination file with the source file.  
OR  
Click **Cancel** to discard the changes.

## 33.6 Reset to Factory Defaults

### 33.6.1 Overview

You can reset the Switch to it's original settings.

Click **Maintenance > Configuration > Factory Default** to display the screen as shown next. Use this screen to reset the Switch back to factory defaults.

Table 186 Maintenance &gt; Configuration &gt; Factory Default

Restore Factory Default		<a href="#">Backup</a>	<a href="#">Restore</a>	<a href="#">Management</a>	<a href="#">Factory Default</a>
This would reset the configuration to factory default and will reboot the system.					
		<a href="#">Restore</a>			

### 33.6.2 Reset the Switch to Factory Defaults

Follow the steps below to reset the Switch back to factory defaults.

1. Click **Restore**.
2. Click **OK** to reset all Switch configurations to the factory defaults. Wait for the Switch to restart. This takes up to two minutes.  
OR  
Click **Cancel** to discard the changes.

Note: If you want to access the Switch web configurator again, you may need to change the IP address of your computer to be in the same subnet as that of the default Switch IP address (192.168.1.1).

## 33.7 Network Diagnostics

Use the network utilities to perform diagnostics.

### 33.7.1 Port Test

Click **Maintenance > Diagnostics > Port Test > Cable Diag** in the navigation panel to open this screen. Use this screen to perform an internal loopback test on an Ethernet port.

**Figure 224** Maintenance > Diagnostics > Port Test > Cable Diag

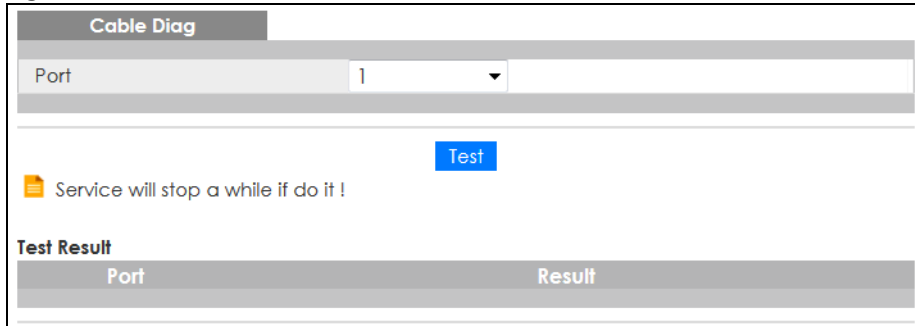

The screenshot shows the 'Cable Diag' interface. At the top, there is a header 'Cable Diag'. Below it, a 'Port' dropdown menu is set to '1'. A blue 'Test' button is positioned to the right of the dropdown. Below the button, a warning icon and text state 'Service will stop a while if do it !'. At the bottom, there is a 'Test Result' section with a table header containing 'Port' and 'Result'.

Follow the steps to perform the port test.

1. In **Port Test**, select the port number from the **Port** drop-down list.
2. Click **Test** to start the port test.

The test results are displayed in **Test Results**.

### 33.7.2 IPv4 Ping Test

Click **Maintenance > Diagnostics > PING > IPv4** in the navigation panel to open this screen. Use this screen to ping an IPv4 server.

Figure 225 Maintenance &gt; Diagnostics &gt; PING &gt; IPv4

The following table describes the labels under **Ping Test**.

Table 187 Maintenance &gt; Diagnostics &gt; PING &gt; IPv4

LABEL	DESCRIPTION
Ping Test	
IP Address	Enter the address of the target host server.
Count	Enter the number of ping packets to send. The range is 1 to 5 packets; the default count is 4.
Interval	Enter the time in seconds between sending ping packets. The range is 1 to 5 seconds; the default is 1 second.
Size	Enter the individual packet size in bytes. The range is 8 to 5120 bytes; the default is 56 bytes.
Apply	Click <b>Apply</b> to save the changes.
Cancel	Click <b>Cancel</b> to discard the changes.

Follow the steps to perform a ping test.

1. In **IP Address**, enter the IPv4 address.
2. In **Count**, enter the number of ping packets.
3. In **Interval**, enter the time interval in seconds.
4. In **Size**, enter the packet size in bytes.
5. Click **Apply** to perform the ping test.  
OR  
Click **Cancel** to discard the changes.

The test results are displayed in **Results**.

### 33.7.3 IPv6 Ping Test

Click **Maintenance > Diagnostics > PING > IPv6** in the navigation panel to open this screen. Use this screen to ping an IPv6 server.

Figure 226 Maintenance &gt; Diagnostics &gt; PING &gt; IPv6

The following table describes the labels in **IPv6 Ping Test**.

Table 188 Maintenance &gt; Diagnostics &gt; PING &gt; IPv6

LABEL	DESCRIPTION
IPv6 Ping Test	
IPv6 Address	Enter the address of the target host server.
Count	Enter the number of ping packets to send. The range is 1 to 5 packets; the default count is 4.
Interval	Enter the time in seconds between sending ping packets. The range is 1 to 5 seconds; the default is 1 second.
Size	Enter the individual packet size in bytes. The range is 8 to 5120 bytes; the default is 56 bytes.
Apply	Click <b>Apply</b> to save the changes.
Cancel	Click <b>Cancel</b> to discard the changes.

Follow the steps to perform a ping test.

1. In **IPv6 Address**, enter the IPv6 address.
2. In **Count**, enter the number of ping packets.
3. In **Interval**, enter the time interval in seconds.
4. In **Size**, enter the packet size in bytes.
5. Click **Apply** to perform the ping test.  
OR  
Click **Cancel** to discard the changes.

The test results are displayed in **Results**.

### 33.7.4 Trace Route

Click **Maintenance > Diagnostics > Trace > Trace Route** in the navigation panel to open this screen. Use this screen to print the route that IP packets take to a network host.

Figure 227 Maintenance &gt; Diagnostics &gt; Trace &gt; Trace Route

The following table describes the labels in **Trace Route**.

Table 189 Maintenance &gt; Diagnostics &gt; Trace &gt; Trace Route

LABEL	DESCRIPTION
Trace Route	
IP Address	Enter the address of the target host server.
Hops	Enter the maximum number of time-to-live or hops used in outgoing probe packets. The range is 2 to 255 packets; the default is 30 hops.
Apply	Click <b>Apply</b> to save the changes.
Cancel	Click <b>Cancel</b> to discard the changes.

Follow the steps to perform a trace route.

1. In **IP Address**, enter the IPv6 address.
2. In **Hops**, enter the number of hops.
3. Click **Apply** to perform the test.  
OR  
Click **Cancel** to discard the changes.

The test results are displayed in **Result**.

## 33.8 Reboot

### 33.8.1 Overview

You can reboot the Switch from the web configurator.



Click **Maintenance > Reboot** in the navigation panel to open this screen. Use this screen to restart the Switch without physically turning the power off.

**Figure 228** Maintenance > Reboot

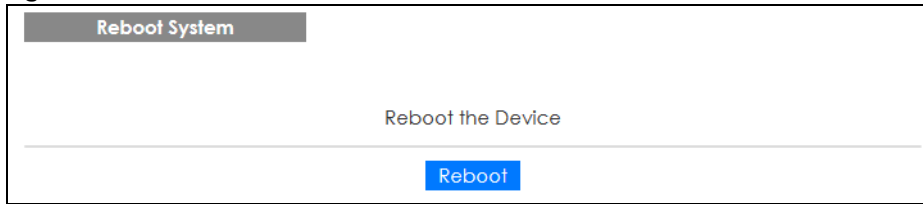

## 33.8.2 Reboot the Switch

Follow the steps below to restart the Switch.

1. Click **Reboot**.
2. Click **OK** and then wait for the Switch to restart. This process takes up to two minutes and does not affect the Switch's configuration.  
OR  
Click **Cancel** to discard the changes.

# CHAPTER 34

## Troubleshooting

This chapter offers some suggestions to solve problems you might encounter. The potential problems are divided into the following categories.

- [Power, Hardware Connections, and LEDs](#)
- [Switch Access and Login](#)
- [Switch Configuration](#)

### 34.1 Power, Hardware Connections, and LEDs

---

[The Switch does not turn on. None of the LEDs turn on.](#)

---

- 1 Make sure the Switch is turned on (in DC models or if the DC power supply is connected in AC/DC models).
- 2 Make sure you are using the power adaptor or cord included with the Switch.
- 3 Make sure the power adaptor or cord is connected to the Switch and plugged in to an appropriate power source. Make sure the power source is turned on.
- 4 Turn the Switch off and on (in DC models or if the DC power supply is connected in AC/DC models).
- 5 Disconnect and re-connect the power adaptor or cord to the Switch (in AC models or if the AC power supply is connected in AC/DC models).
- 6 If the problem continues, contact the vendor.

[One of the LEDs does not behave as expected.](#)

---

- 1 Make sure you understand the normal behavior of the LED. See [Section 3.3 on page 31](#).
- 2 Check the hardware connections. See [Chapter 2 on page 20](#).
- 3 Inspect your cables for damage. Contact the vendor to replace any damaged cables.
- 4 Turn the Switch off and on (in DC models or if the DC power supply is connected in AC/DC models).

- 5 Disconnect and re-connect the power adaptor or cord to the Switch (in AC models or if the AC power supply is connected in AC/DC models).
- 6 If the problem continues, contact the vendor.

## 34.2 Switch Access and Login

---

### I forgot the IP address for the Switch.

---

- 1 The default in-band IP address is **192.168.1.1**.
- 2 If this does not work, you have to reset the device to its factory defaults. See [Section 3.4 on page 32](#) or [Section 33.6 on page 228](#).

---

### I forgot the username and/or password.

---

- 1 The default username is **admin** and the default password is **1234**.
- 2 If this does not work, you have to reset the device to its factory defaults. See [Section 3.4 on page 32](#) or [Section 33.6 on page 228](#).

---

### I cannot see or access the **Login** screen in the web configurator.

---

- 1 Make sure you are using the correct IP address.
  - The default in-band IP address is **192.168.1.1**.
  - If you changed the IP address, use the new IP address.
  - If you changed the IP address and have forgotten it, see the troubleshooting suggestions for [I forgot the IP address for the Switch](#).
- 2 Check the hardware connections, and make sure the LEDs are behaving as expected. See [Chapter 2 on page 20](#).
- 3 Make sure your Internet browser does not block pop-up windows and has JavaScripts and Java enabled.
- 4 Make sure your computer is in the same subnet as the Switch. (If you know that there are routers between your computer and the Switch, skip this step.)
- 5 Reset the device to its factory defaults, and try to access the Switch with the default IP address. See [Section 3.4 on page 32](#) or [Section 33.6 on page 228](#).

- 6 If the problem continues, contact the vendor, or try one of the advanced suggestions.

#### Advanced Suggestions

- Try to access the Switch using another service, such as HTTPS. If you can access the Switch, check the remote management settings to find out why the Switch does not respond to HTTP.

---

I can see the [Login](#) screen, but I cannot log in to the Switch.

---

- 1 Make sure you have entered the user name and password correctly. The default user name is **admin**, and the default password is **1234**. These fields are case-sensitive, so make sure [Caps Lock] is not on.
- 2 Check that you have enabled logins for HTTP. If you have configured a secured client IP address, your computer's IP address must match it. Refer to the chapter on access control for details.
- 3 Disconnect and re-connect the cord to the Switch.
- 4 If this does not work, you have to reset the device to its factory defaults. See [Section 3.4 on page 32](#) or [Section 33.6 on page 228](#).

---

[Pop-up Windows, JavaScripts and Java Permissions](#)

---

In order to use the web configurator you need to allow:

- Web browser pop-up windows from your device.
- JavaScripts (enabled by default).
- Java permissions (enabled by default).

## 34.3 Switch Configuration

---

[I lost my configuration settings after I restart the Switch.](#)

---

Make sure you save your configuration into the Switch's nonvolatile memory each time you make changes. Click **Save** at the top right corner of the web configurator to save the configuration permanently. See also [Section 5.3.1 on page 38](#) for more information about how to save your configuration.



# APPENDIX A

## Customer Support

In the event of problems that cannot be solved by using this manual, you should contact your vendor. If you cannot contact your vendor, then contact a Zyxel office for the region in which you bought the device.

See <http://www.zyxel.com/homepage.shtml> and also [http://www.zyxel.com/about\\_zyxel/zyxel\\_worldwide.shtml](http://www.zyxel.com/about_zyxel/zyxel_worldwide.shtml) for the latest information.

Please have the following information ready when you contact an office.

### Required Information

- Product model and serial number.
- Warranty Information.
- Date that you received your device.
- Brief description of the problem and the steps you took to solve it.

### Corporate Headquarters (Worldwide)

#### Taiwan

- Zyxel Communications Corporation
- <http://www.zyxel.com>

### Asia

#### China

- Zyxel Communications (Shanghai) Corp.
- Zyxel Communications (Beijing) Corp.
- Zyxel Communications (Tianjin) Corp.
- <http://www.zyxel.cn>

#### India

- Zyxel Technology India Pvt Ltd
- <http://www.zyxel.in>

#### Kazakhstan

- Zyxel Kazakhstan
- <http://www.zyxel.kz>

## **Korea**

- Zyxel Korea Corp.
- <http://www.zyxel.kr>

## **Malaysia**

- Zyxel Malaysia Sdn Bhd.
- <http://www.zyxel.com.my>

## **Pakistan**

- Zyxel Pakistan (Pvt.) Ltd.
- <http://www.zyxel.com.pk>

## **Philippines**

- Zyxel Philippines
- <http://www.zyxel.com.ph>

## **Singapore**

- Zyxel Singapore Pte Ltd.
- <http://www.zyxel.com.sg>

## **Taiwan**

- Zyxel Communications Corporation
- <http://www.zyxel.com/tw/zh/>

## **Thailand**

- Zyxel Thailand Co., Ltd
- <http://www.zyxel.co.th>

## **Vietnam**

- Zyxel Communications Corporation-Vietnam Office
- <http://www.zyxel.com/vn/vi>

## **Europe**

### **Austria**

- Zyxel Deutschland GmbH
- <http://www.zyxel.de>

### **Belarus**

- Zyxel BY
- <http://www.zyxel.by>

## **Belgium**

- Zyxel Communications B.V.
- <http://www.zyxel.com/be/nl/>
- <http://www.zyxel.com/be/fr/>

## **Bulgaria**

- Zyxel България
- <http://www.zyxel.com/bg/bg/>

## **Czech Republic**

- Zyxel Communications Czech s.r.o
- <http://www.zyxel.cz>

## **Denmark**

- Zyxel Communications A/S
- <http://www.zyxel.dk>

## **Estonia**

- Zyxel Estonia
- <http://www.zyxel.com/ee/et/>

## **Finland**

- Zyxel Communications
- <http://www.zyxel.fi>

## **France**

- Zyxel France
- <http://www.zyxel.fr>

## **Germany**

- Zyxel Deutschland GmbH
- <http://www.zyxel.de>

## **Hungary**

- Zyxel Hungary & SEE
- <http://www.zyxel.hu>

## **Italy**

- Zyxel Communications Italy
- <http://www.zyxel.it/>

## **Latvia**

- Zyxel Latvia
- <http://www.zyxel.com/lv/lv/homepage.shtml>

## **Lithuania**

- Zyxel Lithuania
- <http://www.zyxel.com/lt/lt/homepage.shtml>

## **Netherlands**

- Zyxel Benelux
- <http://www.zyxel.nl>

## **Norway**

- Zyxel Communications
- <http://www.zyxel.no>

## **Poland**

- Zyxel Communications Poland
- <http://www.zyxel.pl>

## **Romania**

- Zyxel Romania
- <http://www.zyxel.com/ro/ro>

## **Russia**

- Zyxel Russia
- <http://www.zyxel.ru>

## **Slovakia**

- Zyxel Communications Czech s.r.o. organizacna zlozka
- <http://www.zyxel.sk>

## **Spain**

- Zyxel Communications ES Ltd
- <http://www.zyxel.es>

## **Sweden**

- Zyxel Communications
- <http://www.zyxel.se>

## **Switzerland**

- Studerus AG



- <http://www.zyxel.ch/>

### **Turkey**

- Zyxel Turkey A.S.
- <http://www.zyxel.com.tr>

### **UK**

- Zyxel Communications UK Ltd.
- <http://www.zyxel.co.uk>

### **Ukraine**

- Zyxel Ukraine
- <http://www.ua.zyxel.com>

## **Latin America**

### **Argentina**

- Zyxel Communication Corporation
- <http://www.zyxel.com/ec/es/>

### **Brazil**

- Zyxel Communications Brasil Ltda.
- <https://www.zyxel.com/br/pt/>

### **Ecuador**

- Zyxel Communication Corporation
- <http://www.zyxel.com/ec/es/>

## **Middle East**

### **Israel**

- Zyxel Communication Corporation
- <http://il.zyxel.com/homepage.shtml>

### **Middle East**

- Zyxel Communication Corporation
- <http://www.zyxel.com/me/en/>

## North America

### USA

- Zyxel Communications, Inc. - North America Headquarters
- <http://www.zyxel.com/us/en/>

## Oceania

### Australia

- Zyxel Communications Corporation
- <http://www.zyxel.com/au/en/>

## Africa

### South Africa

- Nology (Pty) Ltd.
- <http://www.zyxel.co.za>

# APPENDIX B

## Legal Information

### Copyright

Copyright © 2018 by Zyxel Communications Corporation.

The contents of this publication may not be reproduced in any part or as a whole, transcribed, stored in a retrieval system, translated into any language, or transmitted in any form or by any means, electronic, mechanical, magnetic, optical, chemical, photocopying, manual, or otherwise, without the prior written permission of Zyxel Communications Corporation.

Published by Zyxel Communications Corporation. All rights reserved.

### Disclaimer

Zyxel does not assume any liability arising out of the application or use of any products, or software described herein. Neither does it convey any license under its patent rights nor the patent rights of others. Zyxel further reserves the right to make changes in any products described herein without notice. This publication is subject to change without notice.

### Regulatory Notice and Statement (Class A)

Model List: GS1900-8HP (Revision A1), GS1900-24, GS1900-24HP, GS1900-48, GS1900-48HP

### United States of America



The following information applies if you use the product within USA area.

#### Federal Communications Commission (FCC) EMC Statement

- This device complies with Part 15 of FCC rules. Operation is subject to the following two conditions:
  - (1) This device may not cause harmful interference.
  - (2) This device must accept any interference received, including interference that may cause undesired operations.
- Changes or modifications not expressly approved by the party responsible for compliance could void the user's authority to operate the equipment.
- This equipment has been tested and found to comply with the limits for a Class A digital device, pursuant to part 15 of the FCC Rules. These limits are designed to provide reasonable protection against harmful interference when the equipment is operated in a commercial environment. This equipment generates, uses, and can radiate radio frequency energy and, if not installed and used in accordance with the instruction manual, may cause harmful interference to radio communications. Operation of this equipment in a residential area is likely to cause harmful interference in which case the user will be required to correct the interference at his own expense.

### Canada

The following information applies if you use the product within Canada area

#### Industry Canada ICES statement

CAN ICES-3 (A)/NMB-3(A)

### European Union



The following information applies if you use the product within the European Union.

#### CE EMC statement

WARNING: This equipment is compliant with Class A of EN55032. In a residential environment this equipment may cause radio interference.

List of National Codes

COUNTRY	ISO 3166 2 LETTER CODE	COUNTRY	ISO 3166 2 LETTER CODE
Austria	AT	Liechtenstein	LI
Belgium	BE	Lithuania	LT
Bulgaria	BG	Luxembourg	LU
Croatia	HR	Malta	MT
Cyprus	CY	Netherlands	NL
Czech Republic	CZ	Norway	NO
Denmark	DK	Poland	PL
Estonia	EE	Portugal	PT
Finland	FI	Romania	RO
France	FR	Serbia	RS
Germany	DE	Slovakia	SK
Greece	GR	Slovenia	SI
Hungary	HU	Spain	ES
Iceland	IS	Sweden	SE
Ireland	IE	Switzerland	CH
Italy	IT	Turkey	TR
Latvia	LV	United Kingdom	GB

Safety Warnings

- Do not use this product near water, for example, in a wet basement or near a swimming pool.
- Do not expose your device to dampness, dust or corrosive liquids.
- Do not store things on the device.
- Do not obstruct the device ventilation slots as insufficient airflow may harm your device. For example, do not place the device in an enclosed space such as a box or on a very soft surface such as a bed or sofa.
- Do not install, use, or service this device during a thunderstorm. There is a remote risk of electric shock from lightning.
- Connect ONLY suitable accessories to the device.
- Do not open the device or unit. Opening or removing covers can expose you to dangerous high voltage points or other risks. Only qualified service personnel should service or disassemble this device. Please contact your vendor for further information.
- Make sure to connect the cables to the correct ports.
- Place connecting cables carefully so that no one will step on them or stumble over them.
- Always disconnect all cables from this device before servicing or disassembling.
- Do not remove the plug and connect it to a power outlet by itself; always attach the plug to the power adaptor first before connecting it to a power outlet.
- Do not allow anything to rest on the power adaptor or cord and do NOT place the product where anyone can walk on the power adaptor or cord.
- Please use the provided or designated connection cables/power cables/ adaptors. Connect it to the right supply voltage (for example, 110V AC in North America or 230V AC in Europe). If the power adaptor or cord is damaged, it might cause electrocution. Remove it from the device and the power source, repairing the power adapter or cord is prohibited. Contact your local vendor to order a new one.
- Do not use the device outside, and make sure all the connections are indoors. There is a remote risk of electric shock from lightning.
- Caution: Risk of explosion if battery is replaced by an incorrect type, dispose of used batteries according to the instruction. Dispose them at the applicable collection point for the recycling of electrical and electronic device. For detailed information about recycling of this product, please contact your local city office, your household waste disposal service or the store where you purchased the product.
- Use ONLY power wires of the appropriate wire gauge for your device. Connect it to a power supply of the correct voltage.
- Fuse Warning! Replace a fuse only with a fuse of the same type and rating.
- The POE (Power over Ethernet) devices that supply or receive power and their connected Ethernet cables must all be completely indoors.
- The following warning statements apply, where the disconnect device is not incorporated in the device or where the plug on the power supply cord is intended to serve as the disconnect device,
  - For permanently connected devices, a readily accessible disconnect device shall be incorporated external to the device;
  - For pluggable devices, the socket-outlet shall be installed near the device and shall be easily accessible.
- This device must be grounded. Never defeat the ground conductor or operate the device in the absence of a suitably installed ground conductor. Contact the appropriate electrical inspection authority or an electrician if you are uncertain that suitable grounding is available.
- When connecting or disconnecting power to hot-pluggable power supplies, if offered with your system, observe the following guidelines:
  - Install the power supply before connecting the power cable to the power supply.
  - Unplug the power cable before removing the power supply.
  - If the system has multiple sources of power, disconnect power from the system by unplugging all power cables from the power supply.
- CLASS 1 LASER PRODUCT (for products with mini-GBIC slots or laser products, such as fiber-optic transceiver and GPON products).
- PRODUCT COMPLIES WITH 21 CFR 1040.10 AND 1040.11. (for products with mini-GBIC slots or laser products, such as fiber-optic transceiver and GPON products)
- APPAREIL À LASER DE CLASS 1 (for products with mini-GBIC slots or laser products, such as fiber-optic transceiver and GPON products).
- PRODUIT CONFORME SELON 21 CFR 1040.10 ET 1040.11. (for products with mini-GBIC slots or laser products, such as fiber-optic transceiver and GPON products)

## Environment Statment

### European Union - Disposal and Recycling Information

The symbol below means that according to local regulations your product and/or its battery shall be disposed of separately from domestic waste. If this product is end of life, take it to a recycling station designated by local authorities. At the time of disposal, the separate collection of your product and/or its battery will help save natural resources and ensure that the environment is sustainable development.

Die folgende Symbol bedeutet, dass Ihr Produkt und/oder seine Batterie gemäß den örtlichen Bestimmungen getrennt vom Hausmüll entsorgt werden muss. Wenden Sie sich an eine Recyclingstation, wenn dieses Produkt das Ende seiner Lebensdauer erreicht hat. Zum Zeitpunkt der Entsorgung wird die getrennte Sammlung von Produkt und/oder seiner Batterie dazu beitragen, natürliche Ressourcen zu sparen und die Umwelt und die menschliche Gesundheit zu schützen.

El símbolo de abajo indica que según las regulaciones locales, su producto y/o su batería deberán depositarse como basura separada de la doméstica. Cuando este producto alcance el final de su vida útil, llévelo a un punto limpio. Cuando llegue el momento de desechar el producto, la recogida por separado éste y/o su batería ayudará a salvar los recursos naturales y a proteger la salud humana y medioambiental.

Le symbole ci-dessous signifie que selon les réglementations locales votre produit et/ou sa batterie doivent être éliminés séparément des ordures ménagères. Lorsque ce produit atteint sa fin de vie, amenez-le à un centre de recyclage. Au moment de la mise au rebut, la collecte séparée de votre produit et/ou de sa batterie aidera à économiser les ressources naturelles et protéger l'environnement et la santé humaine.

Il simbolo sotto significa che secondo i regolamenti locali il vostro prodotto e/o batteria deve essere smaltito separatamente dai rifiuti domestici. Quando questo prodotto raggiunge la fine della vita di servizio portarlo a una stazione di riciclaggio. Al momento dello smaltimento, la raccolta separata del vostro prodotto e/o della sua batteria aiuta a risparmiare risorse naturali e a proteggere l'ambiente e la salute umana.

Symbolen innebär att enligt lokal lagstiftning ska produkten och/eller dess batteri kastas separat från hushållsavfallet. När den här produkten når slutet av sin livslängd ska du ta den till en återvinningsstation. Vid tiden för kasseringen bidrar du till en bättre miljö och mänsklig hälsa genom att göra dig av med den på ett återvinningsställe.



## 台灣

警告使用者：

- 這是甲類的資訊產品，在居住的環境中使用時，可能會造成射頻干擾，在這種情況下，使用者會被要求採取某些適當的對策。」

安全警告 - 為了您的安全，請先閱讀以下警告及指示：

- 請勿將此產品接近水、火焰或放置在高溫的環境。
- 避免設備接觸
  - 任何液體 - 切勿讓設備接觸水、雨水、高濕度、污水腐蝕性的液體或其他水份。
  - 灰塵及污物 - 切勿接觸灰塵、污物、沙土、食物或其他不合適的材料。
- 雷雨天氣時，不要安裝，使用或維修此設備。有遭受電擊的風險。
- 切勿重摔或撞擊設備，並勿使用不正確的電源變壓器。
- 若接上不正確的電源變壓器會有爆炸的風險。
- 請勿隨意更換產品內的電池。
- 如果更換不正確之電池型式，會有爆炸的風險，請依製造商說明書處理使用過之電池。
- 請將廢電池丟棄在適當的電器或電子設備回收處。
- 請勿將設備解體。
- 請勿阻礙設備的散熱孔，空氣對流不足將會造成設備損害。
- 請插在正確的電壓供給插座（如：北美 / 台灣電壓 110V AC，歐洲是 230V AC）。
- 假若電源變壓器或電源變壓器的纜線損壞，請從插座拔除，若您還繼續插電使用，會有觸電死亡的風險。
- 請勿試圖修理電源變壓器或電源變壓器的纜線，若有毀損，請直接聯絡您購買的店家，購買一個新的電源變壓器。
- 請勿將此設備安裝於室外，此設備僅適合放置於室內。
- 請勿隨一般垃圾丟棄。
- 請參閱產品背貼上的設備額定功率。
- 請參考產品型錄或是彩盒上的作業溫度。

- 設備必須接地，接地導線不允許被破壞或沒有適當安裝接地導線，如果不確定接地方式是否符合要求可聯繫相應的電氣檢驗機構檢驗。
- 如果您提供的系統中有提供熱插拔電源，連接或斷開電源請遵循以下指導原則
  - 先連接電源線至設備連，再連接電源。
  - 先斷開電源再拔除連接至設備的電源線。
  - 如果系統有多個電源，需拔除所有連接至電源的電源線再關閉設備電源。
- 產品沒有斷電裝置或者採用電源線的插頭視為斷電裝置的一部分，以下警語將適用：
  - 對永久連接之設備，在設備外部須安裝可觸及之斷電裝置；
  - 對插接式之設備，插座必須接近安裝之地點而且是易於觸及的。

## Regulatory Notice and Statement (Class B)

Model List: GS1900-8, GS1900-8HP (Revision B1), GS1900-10HP, GS1900-16, GS1900-24E

### UNITED STATES of AMERICA



The following information applies if you use the product within USA area.

#### FCC EMC Statement

- The device complies with Part 15 of FCC rules. Operation is subject to the following two conditions:
  - (1) This device may not cause harmful interference, and
  - (2) This device must accept any interference received, including interference that may cause undesired operation.
- Changes or modifications not expressly approved by the party responsible for compliance could void the user's authority to operate the device.
- This product has been tested and complies with the specifications for a Class B digital device, pursuant to Part 15 of the FCC Rules. These limits are designed to provide reasonable protection against harmful interference in a residential installation. This device generates, uses, and can radiate radio frequency energy and, if not installed and used according to the instructions, may cause harmful interference to radio communications. However, there is no guarantee that interference will not occur in a particular installation.
- If this device does cause harmful interference to radio or television reception, which is found by turning the device off and on, the user is encouraged to try to correct the interference by one or more of the following measures:
  - Reorient or relocate the receiving antenna
  - Increase the separation between the devices
  - Connect the equipment to an outlet other than the receiver's
  - Consult a dealer or an experienced radio/TV technician for assistance

### CANADA

The following information applies if you use the product within Canada area

#### Industry Canada ICES statement

CAN ICES-3 (B)/NMB-3(B)

### EUROPEAN UNION



The following information applies if you use the product within the European Union.

## List of national codes

COUNTRY	ISO 3166 2 LETTER CODE	COUNTRY	ISO 3166 2 LETTER CODE
Austria	AT	Liechtenstein	LI
Belgium	BE	Lithuania	LT
Bulgaria	BG	Luxembourg	LU
Croatia	HR	Malta	MT
Cyprus	CY	Netherlands	NL
Czech Republic	CZ	Norway	NO
Denmark	DK	Poland	PL
Estonia	EE	Portugal	PT
Finland	FI	Romania	RO
France	FR	Serbia	RS
Germany	DE	Slovakia	SK
Greece	GR	Slovenia	SI
Hungary	HU	Spain	ES
Iceland	IS	Switzerland	CH
Ireland	IE	Sweden	SE
Italy	IT	Turkey	TR
Latvia	LV	United Kingdom	GB

## Safety Warnings

- Do not use this product near water, for example, in a wet basement or near a swimming pool.
- Do not expose your device to dampness, dust or corrosive liquids.
- Do not store things on the device.
- Do not obstruct the device ventilation slots as insufficient airflow may harm your device. For example, do not place the device in an enclosed space such as a box or on a very soft surface such as a bed or sofa.
- Do not install, use, or service this device during a thunderstorm. There is a remote risk of electric shock from lightning.
- Connect ONLY suitable accessories to the device.
- Do not open the device or unit. Opening or removing covers can expose you to dangerous high voltage points or other risks. ONLY qualified service personnel should service or disassemble this device. Please contact your vendor for further information.
- Make sure to connect the cables to the correct ports.
- Place connecting cables carefully so that no one will step on them or stumble over them.
- Always disconnect all cables from this device before servicing or disassembling.
- Do not remove the plug and connect it to a power outlet by itself; always attach the plug to the power adaptor first before connecting it to a power outlet.
- Do not allow anything to rest on the power adaptor or cord and do NOT place the product where anyone can walk on the power adaptor or cord.
- Please use the provided or designated connection cables/power cables/ adaptors. Connect it to the right supply voltage (for example, 110V AC in North America or 230V AC in Europe). If the power adaptor or cord is damaged, it might cause electrocution. Remove it from the device and the power source, repairing the power adapter or cord is prohibited. Contact your local vendor to order a new one.
- Do not use the device outside, and make sure all the connections are indoors. There is a remote risk of electric shock from lightning.
- CAUTION: Risk of explosion if battery is replaced by an incorrect type, dispose of used batteries according to the instruction. Dispose them at the applicable collection point for the recycling of electrical and electronic devices. For detailed information about recycling of this product, please contact your local city office, your household waste disposal service or the store where you purchased the product.
- The following warning statements apply, where the disconnect device is not incorporated in the device or where the plug on the power supply cord is intended to serve as the disconnect device.
  - For permanently connected devices, a readily accessible disconnect device shall be incorporated external to the device;
  - For pluggable devices, the socket-outlet shall be installed near the device and shall be easily accessible.
- CLASS 1 LASER PRODUCT (for products with mini-GBIC slots or laser products, such as fiber-optic transceiver and GPON products).
- PRODUCT COMPLIES WITH 21 CFR 1040.10 AND 1040.11. (for products with mini-GBIC slots or laser products, such as fiber-optic transceiver and GPON products)
- APPAREIL À LASER DE CLASS 1 (for products with mini-GBIC slots or laser products, such as fiber-optic transceiver and GPON products).
- PRODUIT CONFORME SELON 21 CFR 1040.10 ET 1040.11. (for products with mini-GBIC slots or laser products, such as fiber-optic transceiver and GPON products)

## Environment Statement

## ErP (Energy-related Products)

Zyxel products put on the EU market in compliance with the requirement of the European Parliament and the Council published Directive 2009/125/EC establishing a framework for the setting of ecodesign requirements for energy-related products (recast), so called as "ErP Directive (Energy-related Products directive) as well as ecodesign requirement laid down in applicable implementing measures, power consumption has satisfied regulation requirements which are:

- Network standby power consumption < 8W, and/or

- Off mode power consumption < 0.5W, and/or
- Standby mode power consumption < 0.5W.

(Wireless setting, please refer to "Wireless" chapter for more detail.)

### European Union - Disposal and Recycling Information

The symbol below means that according to local regulations your product and/or its battery shall be disposed of separately from domestic waste. If this product is end of life, take it to a recycling station designated by local authorities. At the time of disposal, the separate collection of your product and/or its battery will help save natural resources and ensure that the environment is sustainable development.

Die folgende Symbol bedeutet, dass Ihr Produkt und/oder seine Batterie gemäß den örtlichen Bestimmungen getrennt vom Hausmüll entsorgt werden muss. Wenden Sie sich an eine Recyclingstation, wenn dieses Produkt das Ende seiner Lebensdauer erreicht hat. Zum Zeitpunkt der Entsorgung wird die getrennte Sammlung von Produkt und/oder seiner Batterie dazu beitragen, natürliche Ressourcen zu sparen und die Umwelt und die menschliche Gesundheit zu schützen.

El símbolo de abajo indica que según las regulaciones locales, su producto y/o su batería deberán depositarse como basura separada de la doméstica. Cuando este producto alcance el final de su vida útil, llévelo a un punto limpio. Cuando llegue el momento de desechar el producto, la recogida por separado éste y/o su batería ayudará a salvar los recursos naturales y a proteger la salud humana y medioambiental.

Le symbole ci-dessous signifie que selon les réglementations locales votre produit et/ou sa batterie doivent être éliminés séparément des ordures ménagères. Lorsque ce produit atteint sa fin de vie, amenez-le à un centre de recyclage. Au moment de la mise au rebut, la collecte séparée de votre produit et/ou de sa batterie aidera à économiser les ressources naturelles et protéger l'environnement et la santé humaine.

Il simbolo sotto significa che secondo i regolamenti locali il vostro prodotto e/o batteria deve essere smaltito separatamente dai rifiuti domestici. Quando questo prodotto raggiunge la fine della vita di servizio portarlo a una stazione di riciclaggio. Al momento dello smaltimento, la raccolta separata del vostro prodotto e/o della sua batteria aiuta a risparmiare risorse naturali e a proteggere l'ambiente e la salute umana.

Symbolen innebär att enligt lokal lagstiftning ska produkten och/eller dess batteri kastas separat från hushållsavfallet. När den här produkten når slutet av sin livslängd ska du ta den till en återvinningsstation. Vid tiden för kasseringen bidrar du till en bättre miljö och mänsklig hälsa genom att göra dig av med den på ett återvinningsställe.



## 台灣

安全警告 - 為了您的安全，請先閱讀以下警告及指示：





- 請勿將此產品接近水、火焰或放置在高溫的環境。
- 避免設備接觸任何液體 - 切勿讓設備接觸水、雨水、高濕度、污水腐蝕性的液體或其他水份。
- 灰塵及污物 - 切勿接觸灰塵、污物、沙土、食物或其他不合適的材料。
- 雷雨天氣時，不要安裝，使用或維修此設備。有遭受電擊的風險。
- 切勿重摔或撞擊設備，並勿使用不正確的電源變壓器。
- 若接上不正確的電源變壓器會有爆炸的風險。
- 請勿隨意更換產品內的電池。
- 如果更換不正確的電池型式，會有爆炸的風險，請依製造商說明書處理使用過之電池。
- 請將廢電池丟棄在適當的電器或電子設備回收處。
- 請勿將設備解體。
- 請勿阻礙設備的散熱孔，空氣對流不足將會造成設備損害。
- 請插在正確的電壓供給插座（如：北美 / 台灣電壓 110V AC，歐洲是 230V AC）。
- 假若電源變壓器或電源變壓器的纜線損壞，請從插座拔除，若您還繼續插電使用，會有觸電死亡的風險。
- 請勿試圖修理電源變壓器或電源變壓器的纜線，若有毀損，請直接聯絡您購買的店家，購買一個新的電源變壓器。
- 請勿將此設備安裝於室外，此設備僅適合放置於室內。
- 請勿隨一般垃圾丟棄。
- 請參閱產品背貼上的設備額定功率。
- 請參考產品型錄或是彩盒上的作業溫度。
- 產品沒有斷電裝置或者採用電源線的插頭視為斷電裝置的一部分，以下警語將適用：
  - 對永久連接之設備，在設備外部須安裝可觸及之斷電裝置；
  - 對插接式之設備，插座必須接近安裝之地點而且是易於觸及的。

## About the Symbols

Various symbols are used in this product to ensure correct usage, to prevent danger to the user and others, and to prevent property damage. The meaning of these symbols are described below. It is important that you read these descriptions thoroughly and fully understand the contents.



### Explanation of the Symbols

SYMBOL	EXPLANATION
	Alternating current (AC): AC is an electric current in which the flow of electric charge periodically reverses direction.
	Direct current (DC): DC is the unidirectional flow or movement of electric charge carriers.
	Earth; ground: A wiring terminal intended for connection of a Protective Earthing Conductor.
	Class II equipment: The method of protection against electric shock in the case of class II equipment is either double insulation or reinforced insulation.

### Viewing Certifications

Go to <http://www.zyxel.com> to view this product's documentation and certifications.

### Zyxel Limited Warranty

Zyxel warrants to the original end user (purchaser) that this product is free from any defects in material or workmanship for a specific period (the Warranty Period) from the date of purchase. The Warranty Period varies by region. Check with your vendor and/or the authorized Zyxel local distributor for details about the Warranty Period of this product. During the warranty period, and upon proof of purchase, should the product have indications of failure due to faulty workmanship and/or materials, Zyxel will, at its discretion, repair or replace the defective products or components without charge for either parts or labor, and to whatever extent it shall deem necessary to restore the product or components to proper operating condition. Any replacement will consist of a new or re-manufactured functionally equivalent product of equal or higher value, and will be solely at the discretion of Zyxel. This warranty shall not apply if the product has been modified, misused, tampered with, damaged by an act of God, or subjected to abnormal working conditions.

#### Note

Repair or replacement, as provided under this warranty, is the exclusive remedy of the purchaser. This warranty is in lieu of all other warranties, express or implied, including any implied warranty of merchantability or fitness for a particular use or purpose. Zyxel shall in no event be held liable for indirect or consequential damages of any kind to the purchaser.

To obtain the services of this warranty, contact your vendor. You may also refer to the warranty policy for the region in which you bought the device at [http://www.zyxel.com/web/support\\_warranty\\_info.php](http://www.zyxel.com/web/support_warranty_info.php).

### Registration

Register your product online to receive e-mail notices of firmware upgrades and information at [www.zyxel.com](http://www.zyxel.com) for global products, or at [www.us.zyxel.com](http://www.us.zyxel.com) for North American products.

### Trademarks

ZyNOS (Zyxel Network Operating System) and ZON (Zyxel One Network) are registered trademarks of Zyxel Communications, Inc. Other trademarks mentioned in this publication are used for identification purposes only and may be properties of their respective owners.

### Open Source Licenses

This product contains in part some free software distributed under GPL license terms and/or GPL like licenses. Open source licenses are provided with the firmware package. You can download the latest firmware at [www.zyxel.com](http://www.zyxel.com). To obtain the source code covered under those Licenses, please contact [support@zyxel.com.tw](mailto:support@zyxel.com.tw) to get it.

# Index

## A

- access [36](#)
- administrator password [37](#)
- applications
  - bridging [16](#)
  - IEEE 802.1Q VLAN [17](#)

## C

- certifications [247](#)
  - viewing [249](#)
- Chapter 31 on page 227 [19](#)
- contact information [237](#)
- cookies [36](#)
- copyright [243](#)
- current date/time [46](#)
- customer support [237](#)

## D

- DHCP
  - and domain name [56, 103, 108, 109, 110, 111, 112, 114, 116, 128](#)
- disclaimer [243](#)
- domain name [56, 103, 108, 109, 110, 111, 112, 114, 116, 128](#)

## E

- Ethernet ports
  - default settings [27](#)

## F

- FCC interference statement [243](#)
- Firefox [36](#)
- firmware
  - current version [46](#)
- front panel [25](#)
- FTP [19](#)

## H

- hardware installation [20](#)
- hardware overview [25](#)

## I

- installation
  - freestanding [20](#)
  - precautions [22](#)
- interfaces
  - as DHCP servers [56, 103, 108, 109, 110, 111, 112, 114, 116, 128](#)
- Internet Explorer [36](#)
- Internet Protocol version 6, see IPv6
- introduction [16](#)
- IPv6 [18](#)
  - Neighbor Discovery Protocol [18](#)
  - ping [18](#)

## J

- Java
  - permissions [36](#)
- JavaScripts [36](#)

**L**

- LEDs [31](#)
- logout
  - Web Configurator [38, 39](#)
- loop guard
  - how it works [79](#)
  - probe packet [79, 80](#)

**M**

- MAC address
  - range [46](#)
- managing the device
  - good habits [19](#)
  - using FTP. See FTP.
  - using SNMP. See SNMP.
  - using the web configurator. See web configurator.
- mini GBIC ports [27](#)
  - connection speed [27](#)
  - connector type [27](#)
  - transceiver installation [27](#)
  - transceiver removal [28](#)
- model name [46](#)
- mounting brackets [22](#)
- MSA (MultiSource Agreement) [27](#)
- MSTP [86](#)
- MSTP (Multiple Spanning Tree Protocol) [86](#)
- Multiple Spanning Tree Protocol, See MSTP. [86](#)

**N**

- Netscape Navigator [36](#)

**O**

- one-time schedule [148](#)

**P**

- packet
  - statistics [102, 103, 133, 143, 144, 146, 153, 154, 161, 162, 170, 171, 182, 184, 188, 201, 202, 204, 206, 209, 216, 217, 218, 220](#)
- password
  - administrator [37](#)
- physical ports
  - packet statistics [102, 103, 133, 143, 144, 146, 153, 154, 161, 162, 170, 171, 182, 184, 188, 201, 202, 204, 206, 209, 216, 217, 218, 220](#)
- PoE
  - power management mode [112](#)
- pop-up windows [36](#)
- power module
  - disconnecting [31](#)
- product registration [249](#)
- protocol based VLAN [73](#)
  - and IEEE 802.1Q tagging [73](#)
  - isolate traffic [73](#)

**R**

- rack mounting [22](#)
- Rapid Spanning Tree Protocol, See RSTP. [86](#)
- recurring schedule [148](#)
- registration
  - product [249](#)
- RSTP [86](#)
- rubber feet [20](#)

**S**

- schedule
  - one-time [148](#)
  - recurring [148](#)
  - type [149, 151](#)
- screen resolution [36](#)
- serial number [46](#)
- SNMP [19](#)
- Spanning Tree Protocol, See STP. [86](#)
- status [45](#)
  - LED [31](#)

STP [86](#)  
supported browsers [36](#)  
system name [46](#), [56](#), [57](#), [103](#), [133](#), [134](#), [135](#), [136](#)  
system uptime [46](#)

## T

time range [148](#)  
trademarks [249](#)  
transceiver  
  installation [27](#)  
  removal [28](#)

## U

users  
  currently logged in [46](#)

## V

ventilation holes [20](#)  
VLAN, protocol based, See protocol based VLAN

## W

wall mounting [21](#)  
warranty [249](#)  
  note [249](#)  
Web Configurator  
  access [36](#)  
  requirements [36](#)  
  supported browsers [36](#)  
web configurator [18](#)

## Z

ZON Utility [34](#)